

741GP

Hartland | HARTLAND RANGE | GRID-IT Grid Fix Apertured Plates complete with Fixing Grid

Item Image



Wiring



Dimensions

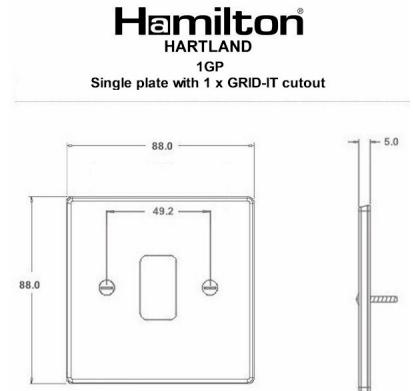

Primary Range	Hartland	
Insert Type	1 gang Grid Fix Aperture Plate with Grid	
Insert Colour	No Insert Colour	
EAN13 Barcode	5051164749019	
Commodity Code	73269098	
Luckins TSI	398036207	
Dimensions(Nominal)	Single: Height = 88.0mm Width = 88.0mm Depth = 5.0mm	
Weight	99 GR	
Switched Poles	N/A	
Current Rating	n/a	
IP Rating	N/A	
Contact Gap Minimum	N/A	
Earth Terminal Capacity 1	11mm ²	
Product Class 1	Face plate must be earthed	
Recommended Location	Internal Use Only	
Maximum Installation Altitude	2000m	
Standard/Approval	N/A	
Additional Notes	See GRID-IT for a full range of inserts. Plates must be Earthed via the Earth Tag.	
All products listed conform to current British or European standard and the product information is correct at the time of going to press.	All accessories are manufactured under an accredited BS EN ISO 9001 : 2015 Quality Management System.	It is the policy of the company to improve products as part of our development programme. Therefore, we reserve the right to alter designs and dimensions without prior notice.
Illustrations and diagrams are reproduced within the limitations of reproduction and printing process and are not binding.	Due to manufacturing processes we cannot guarantee an exact colour match and shadings of of certain finishes.	Correct as at 18 August 2021 07:18 AM E&OE

741GP

Hartland | HARTLAND RANGE | GRID-IT Grid Fix Apertured Plates complete with Fixing Grid

R Hamilton & Co Ltd, Unit 10 Carrick Business Centre, 4-5 Bonville Road,
Brislington, Bristol, BS4 5NZ

T: +44 (0)1747 860088 F: +44 (0)1179 710414

E: info@hamilton-litestat.com www.hamilton-litestat.com

Registered Office 1 Rushmills, Bedford Road, Northampton NN4 7YB

Registered in London No. 941624 VAT Registration No. 222 6607 84



741GP - Hartland Grid-IT Satin Steel 1 gang Grid Fix Aperture Plate with Grid