

DIN Rail terminal blocks / DK..N-PE series

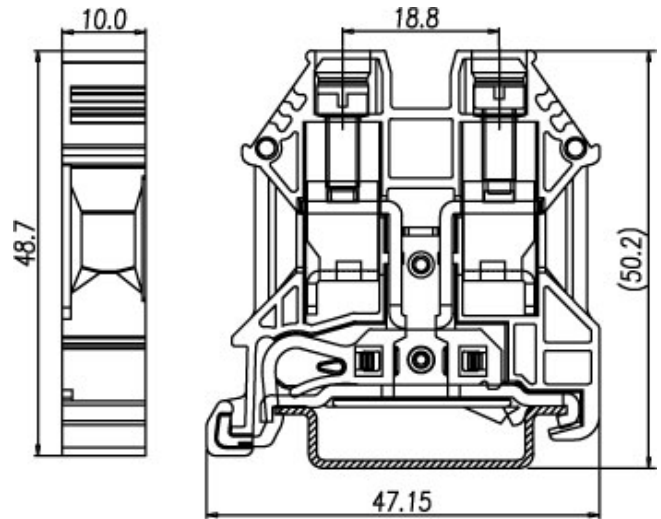

DK10N-PE

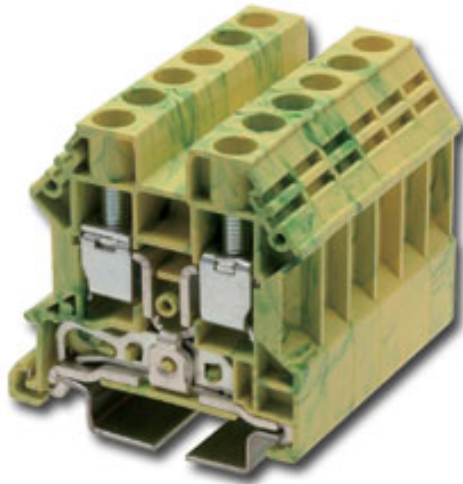

Approval		
Technical Data	UL	IEC
Rated voltage		
Rated current		
Conductor cross-section, solid (AWG / mm ²)	16~6 / 0.5~10	
Conductor cross-section, flexible (AWG / mm ²)	16~6 / 0.5~10	
Rated impulse withstand voltage	8KV	
Torque (N-m)	1.4	
Screw	M4	
Wire strip length	12~14mm	
Insulating material	PA	
TxHxW (mm)	10 x 48.75 x 47.15	
Optional color	Cat. No.	
●		
●		
●		
●		



	Accessories	Cat. No.
End cover		DK10NC-PE
Partition		
Small partition		
Insertion bridge		
Insertion bridge		
Screw-on bridge		
Marking label		TM28
Mounting Rail		TS-35
Tool		