

PRODUCT CODE: AB06G-K
ADAPTABLE BOX - KNOCKOUT

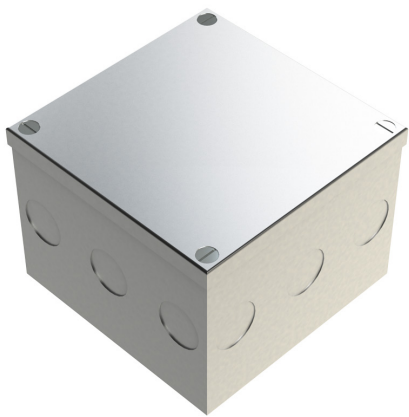

DESCRIPTION

100 x 100 x 75mm (4 x 4 x 3") Adaptable Box with Knock-outs

FINISH

Pre Galvanised

MATERIAL

Galvanised Sheet Steel

PACKAGING

Packed in qty 5 (can be purchased individually)

ADDITIONAL NOTES

Comprises body, flanged cover and M5 x 10mm lid fixing screws
Knock outs - 3 x 20mm on each face
Compliant to LU Standard 1-085 (for use on surface & sub-surface locations)

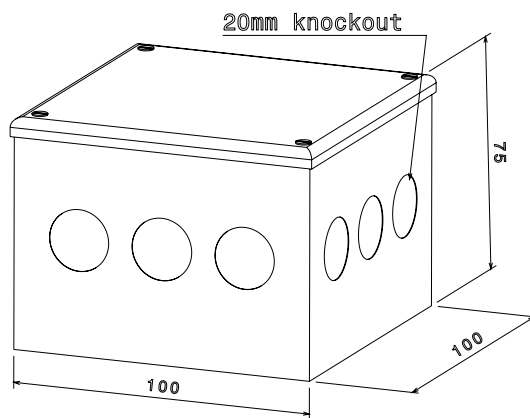

Isometric view

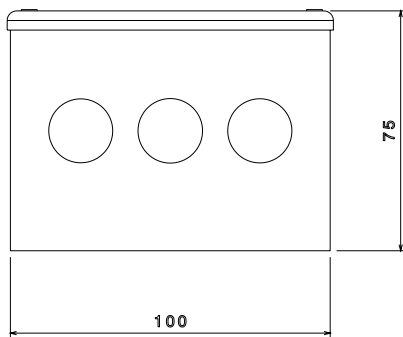

Front view

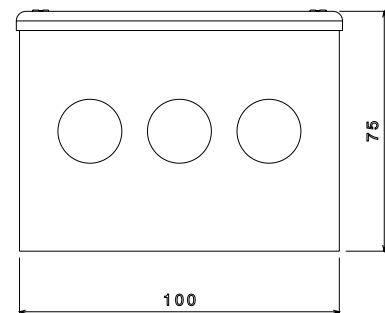

Side view