

PRODUCT CODE: DC2G
DOME COVER

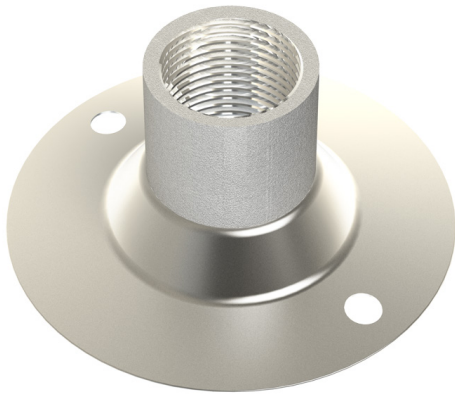

DESCRIPTION

25mm Dome Cover

FINISH

BZP

MATERIAL

Pressed Steel

PACKAGING

Packed in qty 25

ADDITIONAL NOTES

Conforms to BS EN61386-1
Compliant to LU Standard 1-085 (for use on surface & sub-surface locations)

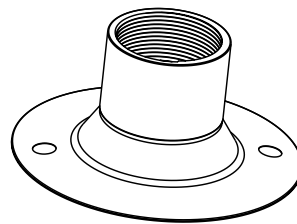

Isometric view

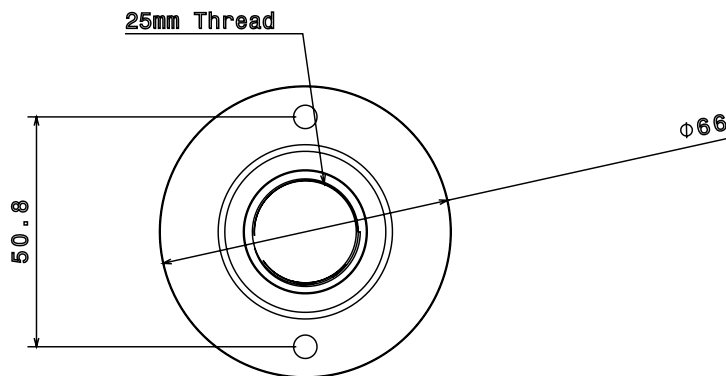

Top view

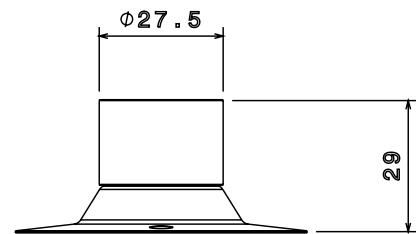

side view