



**220~240V AC OPERATED
PHOTOELECTRIC
SMOKE ALARM
WITH RADIO LINK (868MHZ)**



CLASS II APPARATUS



0086-CPR-638573



KM 673574
BS EN14604:2005



**MODEL: HSSA PE RF
(WITH 9V BATTERY BACK-UP)**

MAIN FEATURES :

- PHOTOELECTRIC SENSOR FOR SLOW SMOLDERING FIRES
- POWER / ALARM INDICATOR
- HUSH FEATURE
- BATTERY BACK UP
- LOW BATTERY WARNING
- WIRELESS INTERCONNECTABLE (UP TO 20 HISPEC SMOKE AND/OR HEAT ALARMS)
- DIP SWITCH FOR CODING
- SUPPLIED WITH FIXING KIT
- LOUD 85DB ALARM SIGNAL

This instruction leaflet contains important information on the correct installation and operation of your heat alarm. Read this leaflet fully before attempting installation and retain for future reference.

SPECIFICATION

Power Source : 220-240Vac~ 50-60Hz with 9V battery back-up (battery included)
 Battery Back-up : 9V Carbon Zinc (Golden Power 1604D, 1604S Golite, Gold Peak 1604P) Alkaline Battery Gold Peak 1604A, Energizer 522, Duracell MN1604)
 Battery Back-up Life : In the event of a break in the mains supply the battery will give detector operation for one month minimum
 Operation Current : <40mA operation (In Alarm)
 Transmit & Receive frequency: 868.4MHz
 Digital modulation method: GFSK
 Transmitting & Receiving distance: over 80M in open space
 Transmit data rate : 50Kbps
 Coding selection : 16 combinations

Max. wireless interconnection: 20 units
 Max. wire interconnection : 40 units
 Sensitivity to smoke : 0.65-1.52 % per foot obscuration
 Operation Temperature : 4°C -50°C
 Ambient Humidity : 10%-90%
 Alarm Sound Level : 85 Decibels at 3 metres

PRODUCT DESCRIPTION

HSSA/PE/RF is a multiple station photoelectric smoke alarm with a radio link mounting base which allows it to be interconnected to other Hispec alarms. (Can be mixed and matched with the Hispec Photoelectric Smoke Alarm HSSA/PE/RF and the Heat Alarm HSSA/HE/RF) The radio link base has both signal transmitter and receiver built-in. It transmits a Radio Frequency(RF) alarm signal when the unit detects smoke. When it receives an RF alarm signal from other unit, it will sound. This interconnect feature allow up to 20 units to be interconnected together within 100 meters and thus all alarms will sound when any one is activated. Using the wireless signal transmission technology awards wiring location problem and allows the smoke and heat alarms to be placed further apart when compared to a wired installation.

Note: This smoke alarm cannot be connected to any other device such as a fire alarm panel.

All the Smoke Alarms should be interconnected to ensure the early warning will be heard, particularly by somebody sleeping. A properly designed early warning fire system ensures the alarm is given before the escape routes become blocked with smoke.

FIGURE 1 - SINGLE STOREY DWELLING

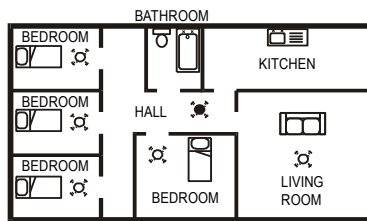
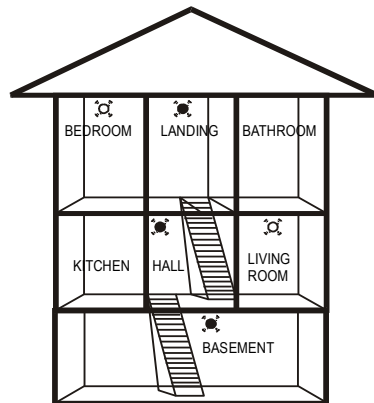

FIGURE 2 - 2/3 STOREY DWELLING



KEY
 MAXIMUM PROTECTION
 MINIMUM PROTECTION

LOCATING THE SMOKE ALARM

If your dwelling is on a single storey, for minimum protection you should fit an alarm in a corridor or hallway between the sleeping and living areas (incl. Kitchens). Place it as near to the living areas as possible and ensure the audible alarm can be heard when the bedrooms are occupied. See Figure 1 for examples.

If your dwelling is multi-storey, for minimum protection one alarm should be fitted at the bottom of the staircase with further alarms fitted on each upstairs landing. This includes basements but excludes crawl spaces and unfinished attics. See Figure 2 for examples.

NOTE: For maximum protection an alarm should be fitted in every room (except kitchen, bathroom and garage).

DO NOT FIT AN ALARM IN THE KITCHEN OR BATHROOM, as cooking fumes or steam may trigger the alarm.
 DO NOT FIT ALARM IN GARAGE, as exhaust fumes are likely to set it off.

POSITIONING THE SMOKE ALARM

Ceiling Mounting

As hot smoke rises and spread out, it is advisable to mount on a ceiling in a central position. Avoid areas where there is no air circulation. E.g. Corners of rooms and keep away from items which may prevent the free flow of air. Place the unit at least 300 mm from and light fitting or decorative object which might obstruct smoke entering the alarm. Keep at least 300 mm away from walls. See Figure 3i.

Wall Mounting

Do not mount tight into the corners. Put the top edge of your smoke alarm between 150 and 300mm below the ceiling. Keep at least 300mm from room corners. See Figure 3j

On a Sloping Ceiling

In areas with sloping or peaked ceilings install your Smoke Alarm 900mm from the highest point measured horizontally because "dead air" at the apex may prevent smoke from reaching the unit. See Figure 3ii.

Figure 3i- Positioning the smoke / heat detector Figure 3ii

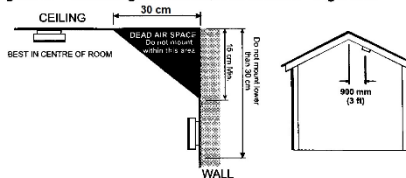

Areas to be avoided include the following :

- Situations where the temperature may fall below 04°C or rise above 50°C
- Humid areas such as bathrooms, kitchens, shower rooms where the relative humidity may exceed 90%
- Near a decorative object, door, light fitting, window molding etc., that may prevent smoke from entering the alarm.
- Fume filled environments such as garages. Exhaust gases may cause false alarms.
- Adjacent to or directly above hot components such as radiators or wall vents that can effect the direction of air currents.

- In very dusty or dirty environments such as workshops.
- Locate unit at least 1.5m and route wiring at least 1m away for fluorescent light fittings as electrical "noise" and/or flickering may affect the unit. Do not wire into the same circuit as fluorescent lights or dimmers.
- Do not locate in insect infested areas. Insects and contamination on the alarm sensor can increase its response time.

INSTALLING THE SMOKE ALARM

WARNING – This smoke alarm is mains powered and requires wiring by a qualified electrician in accordance with the current IEE Regulations for Electrical Installations (BS7671).

The circuit used to power the smoke alarm must be a dedicated permanent supply that cannot be switched off accidentally by the normal user. Before installing ensure the electrical supply is isolated.

WARNING: To prevent injury, this smoke alarm must be securely attached to the ceiling/wall in accordance with the installation instructions.

All hardwired interconnect smoke alarms must be supplied from a single power circuit and a common neutral must be used.

WARNING: Do not connect the interconnect wire to Live or Neutral.

- Disconnect the AC main power from the circuit that is going to be used.
- Having established the mounting location install a junction box suitable for locating the termination point. Ensure that there is no other electrical wiring or pipe work in the area adjacent to the mounting surface.
- Unlock the detector unit from the base by pushing up the temporary latch with a screw driver. See Figure 4

Figure 4 – Release Temporary Lock

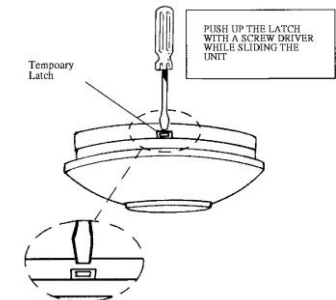

- Set the coding. Each unit comes a four positions dip switch (see Figure 6) for coding the transmit and receive frequency to prevent interference with any other RF equipment. There are 16 combinations.

Figure 6 – DP Switch setting facility

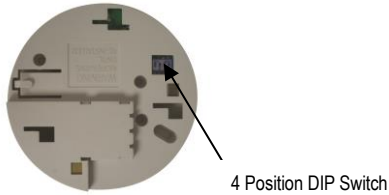

IMPORTANT!

The setting of the dip switch must be the same on all interconnected units.

- Connect the wires to the correct terminals on the mounting base and fix the mounting base in position. Ensure the screws are fully tightened. See Figure 5.

Figure 5 – Wiring & Interconnect facility

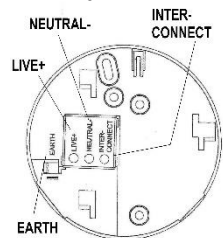

The alarm must be wired in accordance with National wiring codes. LIVE : connect to house wires coloured Brown, Red or marked with L. NEUTRAL : connect to house wires coloured Blue, Black or marked with N. INTERCONNECT : normally not used except to hardwire interconnect to the mains smoke (Hispec model HSSA/PE) or heat alarm (Hispec model HSSA/HE). Never use EARTH wire for interconnect wire.

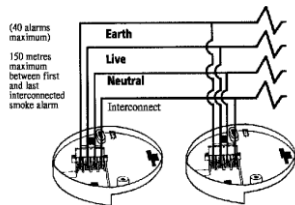

Remark

HSSA/PE/RF smoke alarm & HSSA/HE/RF heat alarm are detectors, which can be interconnected with each other by wireless radio links. In another case, the user will have the option to interconnect them to the other hard wired type smoke alarms by the wiring be the "interconnection terminal" on the base.

WARNING: Connection to the EARTH terminal is not needed for correct functioning of the Smoke Alarm. It is just for conveniently terminating any earth supply wire coloured green or green/yellow. It does not provide protective earthing for the Smoke Alarm.

- Insert a 9V battery firmly into battery compartment on the rear of the alarm. NOTE POLARITY OF CONNECTIONS. Ensure the metal tab is fully depressed when the battery has been fitted. NOTE – For the safety of the end user the smoke alarm cannot be fitted without its battery.
- Before assembly to base plate test the correct operation of the smoke alarm (operating from the battery only) by depressing the test button on the front of the alarm. The unit should emit a loud pulsating alarm.
- Assemble alarm onto the mounting plate by sliding it in according to the direction of the arrows.
- Restore the AC supply
- Test the correct operation of the smoke alarm by depressing the test button on the front of the detector. The unit should emit a loud pulsating alarm.
- Should use 2.1mm wire for connection.

OPERATING YOUR SMOKE ALARM

Once the smoke alarm has been installed a small GREEN indicator light (LED) should be visible through the alarm grill indicating that AC supply is healthy. A RED indicator light (LED) should also flash approximately once a minute to indicate the battery is healthy and the unit is operating properly.

If smoke is detected, the unit will emit a loud pulsating alarm and a RED indicator light (LED) will be flashing quickly at the same time until the air is clear.

At normal time, the radio link module is working under sleep mode. It will open the receiving window at a short time around every 20 seconds. In order to awake it and set it at transmission mode, the simplest way is to press the button on top of the smoke detector. It will continually transmit as long as the button is pressed.

To test two units' transmission and reception performances/parameters, it is important to set them with the same code. The dip switch for setting the code is available on the mounting base of the unit. When one is at its receiving mode, it can receive a triggering signal from the transmitting unit within 20 seconds. As soon as the receiving unit gets the signal, it will activate the alarm to sound loudly until the transmitting signal is vanished.

TESTING YOUR SMOKE ALARM

It is recommended that you test your smoke alarm once a week to ensure the detector is working correctly. Push and hold the test button for approximately 3 seconds. A loud pulsating alarm should sound and a RED indicator light (LED) will flash at the same time.

NOTE – for multiple interconnected smoke alarms (either by radio link or hardwire), only the RED indicator light (LED) of the originating unit will flash rapidly. All other units in the interconnect system will sound an alarm (for radio link interconnected units, it will sound within 20 seconds) but their RED indicator light (LED) will NOT flash. Test each alarm checking that the alarm is triggered on all other alarms installed.

HUSH OR SILENCE FEATURE

This Smoke Alarm has a built-in Hush or Silence feature incorporated into the Test button. If cooking or other non-hazardous sources cause the unwanted alarm, it can be temporarily silenced by depressing the test button and holding for approximately 3 seconds. The alarm will enter a dormant period for 10 minutes. The red LED will flash every 10 seconds to indicate the sensitivity is reduced. At the end of the hush period the alarm will reset to normal sensitivity.

NOTE – If the smoke density increase during this period (i.e. from a fire) the unit will go into alarm mode.

LOW BATTERY WARNING

If the smoke alarm emits a short 'beep' once a minute the battery is at the end of its life and should be replaced immediately. This low voltage warning will be given for at least 30 days. In this case, the other interconnected units in the system which are not in low battery condition will chirp for a few seconds once an hour as long as the detector with the "dead" battery beeps.

If the red indicator light (LED) does not flash every minute then replace the battery.

BATTERY REPLACEMENT

Always TURN OFF the A.C. supply to the smoke alarm before replacing the battery. Replace the battery at least once annually, or immediately when the low battery signal sounds once a minute, even though the smoke alarm is receiving A.C. power.

Test the alarm for correct operation using the test facility whenever the battery is replaced.

WARNING: DANGER OF EXPLOSION IF BATTERY IS INCORRECTLY REPLACED. THE USE OF BATTERIES OTHER THAN THOSE RECOMMENDED ON THE BACK OF THE SMOKE ALARM MAY BE DETRIMENTAL TO ITS OPERATION

The battery should only be replaced by a qualified electrician or similarly qualified person.

- Turn off the A.C. power supply to the smoke alarm.
- Gently slide the smoke alarm out from the mounting plate.
- Remove the battery from the compartment.
- Insert a new, healthy 9V battery. NOTE POLARITY OF CONNECTIONS. Ensure the metal tab is fully depressed when the battery has been fitted
- Using the Push-to-Test button, test the smoke alarm to verify 9V DC battery back-up. See "TESTING YOUR SMOKE ALARM"
- Reattached the smoke alarm to the mounting plate by sliding until it snaps into place.
- Turn on the AC power and test the smoke alarm using the Push-to-Test button. See "TESTING YOUR SMOKE ALARM"

MAINTAINING YOUR SMOKE ALARM

Clean your smoke alarm at least once every six months to prevent dust build up. This can be done using a vacuum cleaner with the brush attachment. Clean gently around the front grilled section and sides.

The apparatus shall not be exposed to dripping or splashing and no objects filled with liquids, such as vases, shall be placed on the apparatus.

IMPORTANT SAFEGUARDS

Installation of your smoke alarm is only one step in your safety plan. Other important steps should be taken to further improve your safety:-

- Install the smoke alarm properly, following this instruction leaflet
- Test your smoke alarm weekly
- Replace the battery immediately once depleted

- Do not smoke in bed
 - Keep matches & lighters away from children
 - Store flammable materials in a proper manner and never use them near naked flames or sparks
 - Maintain emergency equipment such as Fire Extinguishers, escape ladders etc and ensure all occupants know how to use them correctly.
 - Plan an escape route/s from your building in advance and ensure all occupants are aware of them. Re-enforce this awareness periodically through-out the year.
 - Make sure escape routes remain free of any obstructions.
- WARNING: IF THERE IS ANY QUESTION AS TO THE CAUSE OF AN ALARM IT SHOULD BE ASSUMED THAT THE ALARM IS DUE TO AN ACTUAL FIRE AND THE DWELLING SHOULD BE EVACUATED IMMEDIATELY.**
- THIS PRODUCT IS A SEALED UNIT AND CANNOT BE REPAIRED – IF THE UNIT IS TAMPERED WITH IT WILL INVALIDATE THE GUARANTEE. IF THE UNIT IS FAULTY PLEASE RETURN IT TO YOUR ORIGINAL SUPPLIER WITH YOUR PROOF OF PURCHASE.

YOUR SMOKE ALARM GUARANTEE

These smoke alarms are guaranteed to be free from defects in materials and workmanships under normal use and service for a period of three years from date of purchase. The company will not be obligated to repair or replace parts which are found to be in need of repair because of misuse, damage or alterations occur after the date of purchase. Send the Smoke Alarm with proof of purchase, postage and return postage prepaid, to local distributor. The liability of the company arising from the sale of this smoke alarm shall not in any case exceed the cost of replacement of smoke alarm and in no case shall the company be liable for consequential loss or damages resulting from the failure of the smoke alarm.

HISPEC ELECTRICAL PRODUCTS LTD. SHALL HAVE NO LIABILITY FOR ANY PERSONAL INJURY OR PROPERTY DAMAGE, OR ANY SPECIAL INCIDENTAL, CONTINGENT OR CONSEQUENTIAL DAMAGE OF ANY KIND RESULTING FROM A FIRE. THE EXCLUSIVE REMEDY FOR BREACH OF THE LIMITED WARRANTY CONTAINED HEREIN IS THE REPAIR OR REPLACEMENT OF THE DETECTIVE PRODUCT AT HISPEC ELECTRICAL PRODUCTS LTD. OPTION. IN NO CASE SHALL HISPEC ELECTRICAL PRODUCTS LTD.'S LIABILITY UNDER ANY OTHER REMEDY PRESCRIBED BY LAW EXCEED THE PURCHASE PRICE. YOUR SMOKE ALARMS IS NOT A SUBSTITUTE FOR PROPERTY, DISABILITY, LIFE OR OTHER INSURANCE OF ANY KIND. APPROPRIATE COVERAGE IS YOUR RESPONSIBILITY. CONSULT YOUR INSURANCE AGENT.

This does not affect your statutory rights. This alarm is only suitable for single occupancy private dwellings only and not intended for multi occupancy private dwellings or commercial or industrial dwellings.

Waste electrical products should not be disposed of with normal household waste. Please recycle where facilities exist. Check with your Local Authority or retailer for recycling advice. New regulation will encourage the recycling of Waste from Electrical and Electronic Equipment (European "WEEE Directive" effective August 2005).



Hispec Electrical Products Ltd
www.hispec.co.uk

Ver: 06-JUL-2017