

TIMEGUARD®

Digital Economy Seven Programmer

Model: TRTD7N - White



Installation & Operating Instructions

1. General Information

These instructions should be read carefully and retained for further reference and maintenance.

2. Safety

- Before installation or maintenance, ensure the mains supply to the time switch is switched off and the circuit supply fuses are removed or the circuit breaker turned off.
- It is recommended that a qualified electrician is consulted or used for the installation of this time switch and install in accordance with the current IEE wiring and Building Regulations.
- Check that the total load on the circuit including when this time switch is fitted does not exceed the rating of the circuit cable, fuse or circuit breaker.

3. Technical Specifications

- 230V AC 50 Hz
- This time switch is of Class I Construction and must be earthed
- Switch Rating: 13A Resistive (3kW) Immersion Heaters
- Switch Type: Micro-disconnection ON control.
Disconnection to immersion heater(s) via double pole rocker switch
- 24 hour Programme: 10 selectable pre-set tariff programmes (0 – 9)
- Boost Times: 30, 60, 120 minutes
- Economy Output Light: Blue LED
- Battery Backup: 2 year reserve, factory fitted rechargeable non-replaceable
- IP30 Rated suitable for restricted internal applications
- CE Compliant
- Dimensions (H x W x D): 111.5 x 170 x 60mm

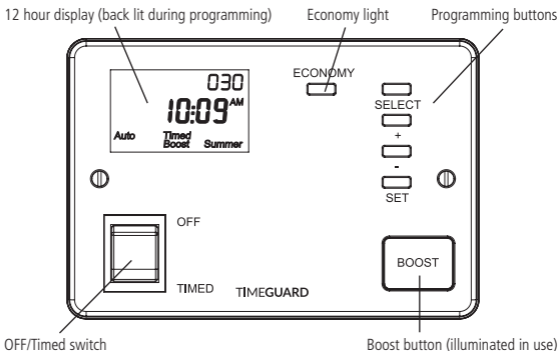

4. Installation

Suitable for use with single, dual, or twin element immersion heaters.

- 4.1 Ensure the mains supply is switched off and the circuit supply fuses are removed or the circuit breaker turned off.
- 4.2 Remove the 2 fixing screws holding the front panel to the back box.
- 4.3 Decide which mounting holes you would like to use and select a suitable cable entry point by drilling into the back box ensuring not damage or infringe on any of the internal components.
- 4.4 Mark the position of the mounting holes on the wall using the back box as a template. Drill out the mounting holes taking care to avoid any joists, electrical cables or water/gas pipes that may be hidden beneath the surface. Insert the rawl plugs into the holes.
- 4.5 Pass the 230V 50Hz mains supply and load cables through the cable entry point(s) on the back box.
- 4.6 Fix the back box to the wall using the correct mounting screws for the rawl plugs installed.
- 4.7 Use the cable clamp in the back box to secure the cables.
- 4.8 Terminate the cables into the terminal block ensuring correct polarity is observed and that all bare conductors are sleeved (See section 5. Connection Diagram).
- 4.9 Select and set your preferred program and time setting using the adjusters located on the reverse of the front panel (See section 6. Commissioning).

5. Connection Diagram

Connect the cables to the terminal block which are marked as follows;

- 230V 50Hz mains – Single element immersion heaters only.

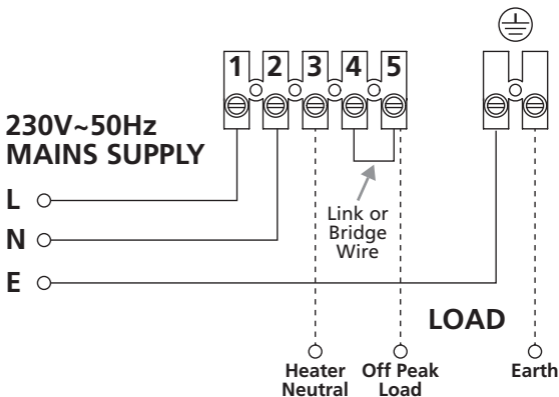

3

230V 50Hz Mains Supply

Live Supply (Brown or Red) to

terminal 1

Neutral Supply (Blue or Black) to

terminal 2

Earth (Green/Yellow) to



Load

Switch Live, Off peak load (Brown or Red) to

terminal 5

Heater Neutral (Blue or Black) to

terminal 3

Earth (Green/Yellow) to



Note: a link or bridge will need to be fitted between terminal 4 and terminal 5 if you wish to use the Boost button (single element immersion heaters only).

- 230V 50Hz mains – Twin or Dual element immersion heaters.

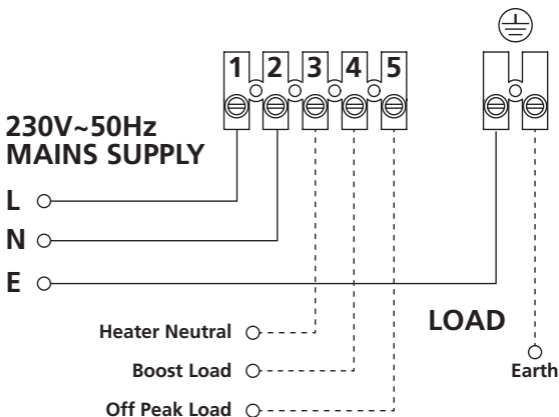

4

230V 50Hz Mains Supply

Live Supply (Brown or Red) to

terminal 1

Neutral Supply (Blue or Black) to

terminal 2

Earth (Green/Yellow) to



Load

Switch Live, Off peak load –

Primary element (Brown or Red) to

terminal 5

Switch Live, Boost load –

Secondary element (Brown or Red) to

terminal 4

Heater Neutral (Blue or Black) to

terminal 3

Earth (Green/Yellow) to



6. Commissioning

Reverse of the front panel

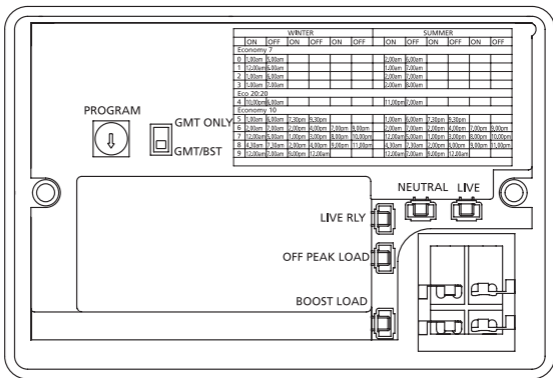

5

Tariff Table

- These are pre-programmed times which can be selected and modified.

WINTER							SUMMER						
	ON	OFF	ON	OFF	ON	OFF	ON	OFF	ON	OFF	ON	OFF	
Economy 7													
0	1.00am	5.00am					2.00am	6.00am					
1	12.00am	6.00am					1.00am	7.00am					
2	1.00am	6.00am					2.00am	7.00am					
3	1.00am	7.00am					2.00am	8.00am					
Eco 20:20													
4	10.00pm	6.00am					11.00pm	7.00am					
Economy 10													
5	1.00am	6.00am	7.30pm	9.30pm			1.00am	6.00am	7.30pm	9.30pm			
6	2.00am	7.00am	2.00pm	4.00pm	7.00pm	9.00pm	2.00am	7.00am	2.00pm	4.00pm	7.00pm	9.00pm	
7	12.00am	5.00am	1.00pm	3.00pm	8.00pm	10.00pm	12.00am	5.00am	1.00pm	3.00pm	8.00pm	10.00pm	
8	4.30am	7.30am	2.00pm	4.00pm	9.00pm	11.00pm	4.30am	7.30am	2.00pm	4.00pm	9.00pm	11.00pm	
9	12.00am	7.00am	9.00pm	12.00am			12.00am	7.00am	9.00pm	12.00am			

- Contact your energy supplier to check which energy plan you are on, and whether the off peak times change during winter and summer.
- On the tariff table (located on the reverse of the front panel), find which program collates with your energy plan. Using a terminal screwdriver, turn the program selector to the correct number for the program (if you want a program that is not shown on the table, select the closest one to your desired program and this can be adjusted later).
- On the back of the unit select GMT ONLY or GMT/BST depending on your energy plan;
 - GMT ONLY fixes the time to GMT.
 - GMT/BST sets GMT over the winter period, and GMT+1 over the summer period.

Winter and Summer are displayed according to daylight saving periods regardless of the switch position.

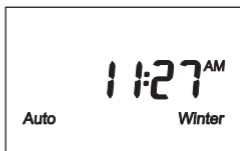
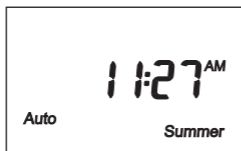

- Ensure all terminals are secured and screw the front panel of the unit to the back box using the 2 fixing screws previously removed.

Operating Modes

- **OFF:** With the rocker switch set to OFF, there is no output regardless of the program or boost. The unit can still be programmed and the internal battery will charge.
- **TIMED:** With the rocker switch set to TIMED, the output will be according to the program, or the appropriate boost period. Auto will be displayed on the screen in this mode.

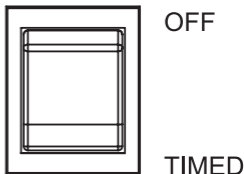

Sleep Mode

- If power is removed the screen will go blank after 10 seconds. The screen will be revived when power is restored.
- The screen can be woken by pressing any button.
- The programmes will remain in the memory when power is off.

Illumination

- Press any button to illuminate the screen. The illumination times out automatically 60 seconds after the last button press.
- The Economy Light illuminates during off peak times.

ECONOMY



- The Boost Button surround illuminates during boost periods.



7

OFF peak times

- During OFF peak times (selected but the tariff switch) the display will show;

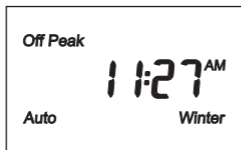

7. Reset

- Press and hold the + and – buttons simultaneously until the screen goes blank.



+



-

- Release the buttons and after a few seconds all of the digits will appear.

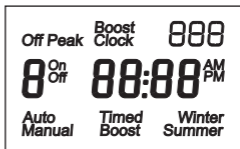

- The factory default settings will now be restored, and the date and time will need re-programming.

8

8. Setting the current time and date

- Press the SET button once.



SET

- The word 'Clock' will be displayed on the top of the screen along with the hour flashing.



- Use the + and – buttons to set the required hour (when adjusting values, hold the + or – button to scroll faster).



+



-

- Press the SELECT button once to save and the minutes will start to flash.



SELECT

- Use the + and – buttons to set the required minutes and press the SELECT button once to save. The year will start to flash.



- Use the + and – buttons to set the required year and press the SELECT button once to save. The month will start to flash.



- Use the + and – buttons to set the required month and press the SELECT button once to save. The day will start to flash.
- Use the + and – buttons to set the required day and press the SELECT button once to save.

- The screen will now show the correct time and season.



9. Reviewing and editing programmes

- Press the SET button twice.



SET

- The hour for the ON time will start flash.

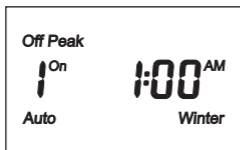

- Use the + and – buttons to alter the hour.



+



-

- Press the SELECT button once to save and the minutes will start to flash.



SELECT

- Use the + and – buttons to alter the minutes and press the SELECT button once to save. The hour for the OFF time will start to flash.
- Use the + and – buttons to alter the hour and press the SELECT button once to save. The minutes will start to flash.
- Use the + and – buttons to alter the minutes and press the SELECT button once to save.

Note: pressing SELECT will either exit to the main screen, or allow you to alter other time periods if they are available on the chosen tariff.

- If the programs are changed manually away from the pre-set tariff, then MANUAL will be displayed on the screen.

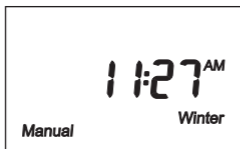

10. Manual Boost

- The BOOST button and screen will illuminate when the boost is pressed.



- Press the BOOST button once for 30 minutes, twice for 60 minutes or three times for 120 minutes. A fourth press will cancel the boost time.

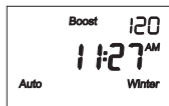
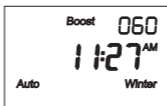
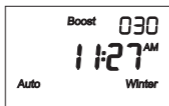

Note: The screen will show the remaining time of the boost period. The BOOST button surround is illuminated for the duration of the boost period. The boost is disabled during the economy period. The boost will self-cancel if the economy period starts during a boost period.

11. Programmed Boost

- Press the SET button three times.



SET

- The hour for the ON time will start to flash.



- Use the + and – buttons to alter the hour for the ON time.



+



-

- Press the SELECT button once to save and the minutes will start to flash.



SELECT

- Use the + and – buttons to alter the minutes and press the SELECT button once to save. The hour for the OFF time will start to flash.

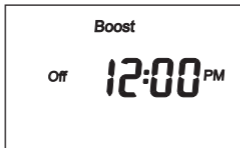

- Use the + and – buttons to alter the hour for the OFF time, and press the SELECT button once to save. The minutes will start to flash.
- Use the + and – buttons to alter the minutes and press the SELECT button once to save.
- Press the SELECT button once to exit to the main screen.



SELECT

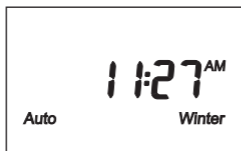

Activating the programmed boost

- Press the SELECT button once.



SELECT

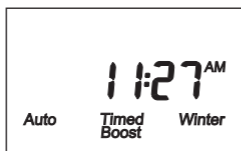

- Leave for 60 seconds to time out.
- Press the SELECT button once to cancel.



SELECT

Note: During a boost period the boost button surround will illuminate.

3 Year Guarantee

In the unlikely event of this product becoming faulty due to defective material or manufacture within 3 years of the date of purchase, please return it to your supplier in the first year with proof of purchase and it will be replaced free of charge. For the second and third years or any difficulty in the first year telephone the helpline on 020 8450 0515.

Note: A proof of purchase is required in all cases. For all eligible replacements (where agreed by Timeguard) the customer is responsible for all shipping/postage charges outside of the UK. All shipping costs are to be paid in advance before a replacement is sent out.



If you experience problems, do not immediately
return the unit to the store.

Telephone the Timeguard Customer Helpline;

HELPLINE

020 8450 0515

or email helpline@timeguard.com

Qualified Customer Support Co-ordinators will be on-line
to assist in resolving your query.



A **theben** Group Company

For a product brochure please contact:

Timeguard Limited.

Victory Park, 400 Edgware Road,
London NW2 6ND

Sales Office: 020 8452 1112
or email csc@timeguard.com

www.timeguard.com

TW - July 2021