

ACCESSORIES

Technical Specification

Product Code: OVCG24V30IP20

Description: 30W 24V Constant Voltage LED Driver – Compact

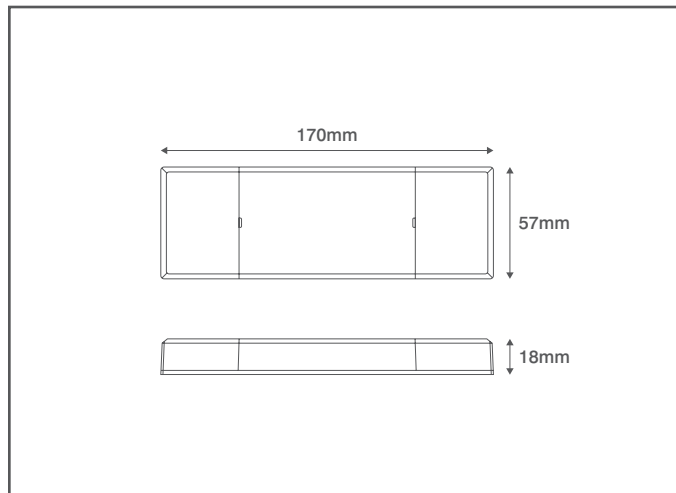

General Information

Dimensions	170mm (L) x 57mm (W) x 18mm (D)
Materials	Housing: Polycarbonate
Finish	White
Product Weight	0.15Kg
Dimmable	No
Ingress Protection	IP20
Warranty	5 Years

Supply & Power

Input Voltage & Frequency	220-240V~ 50/60Hz
Electrical Safety	Class II (Double Insulated)
Rated Power	30W Max.
Ambient Temperature (Ta)	-25°C - +45°C
Critical Temperature	+90°C
Cable Size	0.75mm ² -1.5mm ² (Input)
Input Terminations	Push-fit Terminals

Input Information

Input Current	≤21mA
Input Power	<36W
Power Factor	≥0.92
16A Circuit Breaker	Type B: 35
Inrush Current	<35A/280μs

Output Information

Output Voltage	24V DC
Output Current	0-1250mA
Output Power (Max.)	30W
Efficiency	≥85%

Protection

Short Circuit Protection	Auto Recovery
Overload Protection	Auto Recovery
No Load Protection	Auto Recovery
Insulation Voltage	3000V 5mA 60S between P-S
Insulation Resistance	>100M Ohm @ 500VDC
Leakage Current	<250μA, I/P to PE @230V~ input
Flicker Free	Yes

