

CAPTURE® P15-W, Q20-W, D20-W, CQ-W,
CD-W, LR50-W, PET-W, C15-W
G2 Wireless Motion Detectors
INS879EN-11

16-09-2024	<ul style="list-style-type: none"> • PCR1473 - Kiwa changes to descriptions of pet modes. Details added confirming non compliance with relevant standards. • Updated logos to include UKCA Mark • Manual created • PCR01862 changes incorporated for pet compliance statement. And nominal height for ceiling mount devices. • Changes made PCR01383 • PCR01862 - changes to the statement regarding non-compliance in Pete mode. Addition of text regarding low battery signals and how to clear them. Additionally, removed the word Telefication. • PCR01383 Updated walk test diagrams following request from Kiwa certification engineers. • LRS0 model added • PCR01383 changes to pet coverage patterns and compliance statement for pet. • Added Capture PET-W • PCR13083 updated battery low voltage signal • PCR01383 altered quiescent currents and added low battery statement in line with KIWA requirements.
23-10-2024	<ul style="list-style-type: none"> • Added C15-W

Content

- 1.0 Quick installation** 4
 - 1.1 Opening the device 4
 - 1.2 Mounting & Learning 8
 - 1.3 Mode selection 16
 - 1.4 Closing the device 23
 - 1.5 Testing commissioning and LED indications 25
- 2.0 Variants** 28
 - 2.1 CAPTURE P15-W 28
 - 2.2 CAPTURE Q20-W 36
 - 2.3 CAPTURE D20-W 44
 - 2.4 CAPTURE CQ-W 50
 - 2.5 CAPTURE CD-W 54
 - 2.6 CAPTURE LR50-W 58
 - 2.7 CAPTURE PET-W 60
 - 2.8 CAPTURE C15-W 63
- 3.0 Accessories** 65
 - 3.1 Branding 65
 - 3.2 Optional wall or ceiling brackets 70
- 4.0 Specifications** 75
- 5.0 Legal information** 77
 - 5.1 Supplier 77
 - 5.2 WEEE Directive 78
 - 5.3 Maintenance 78
 - 5.4 Warranty 78
 - 5.5 Battery safety 79

1.0 Quick installation

1.1 Opening the device

The devices are supplied in the unlocked position. If locked;

- Use a flat bladed terminal driver and turn the locking mechanism $\frac{1}{4}$ turn anti-clockwise.
- Slide the front down and towards you to remove.
- For ceiling mount devices remove the facia by turning it anti-clockwise, and then unlock as above.

Locking mechanism

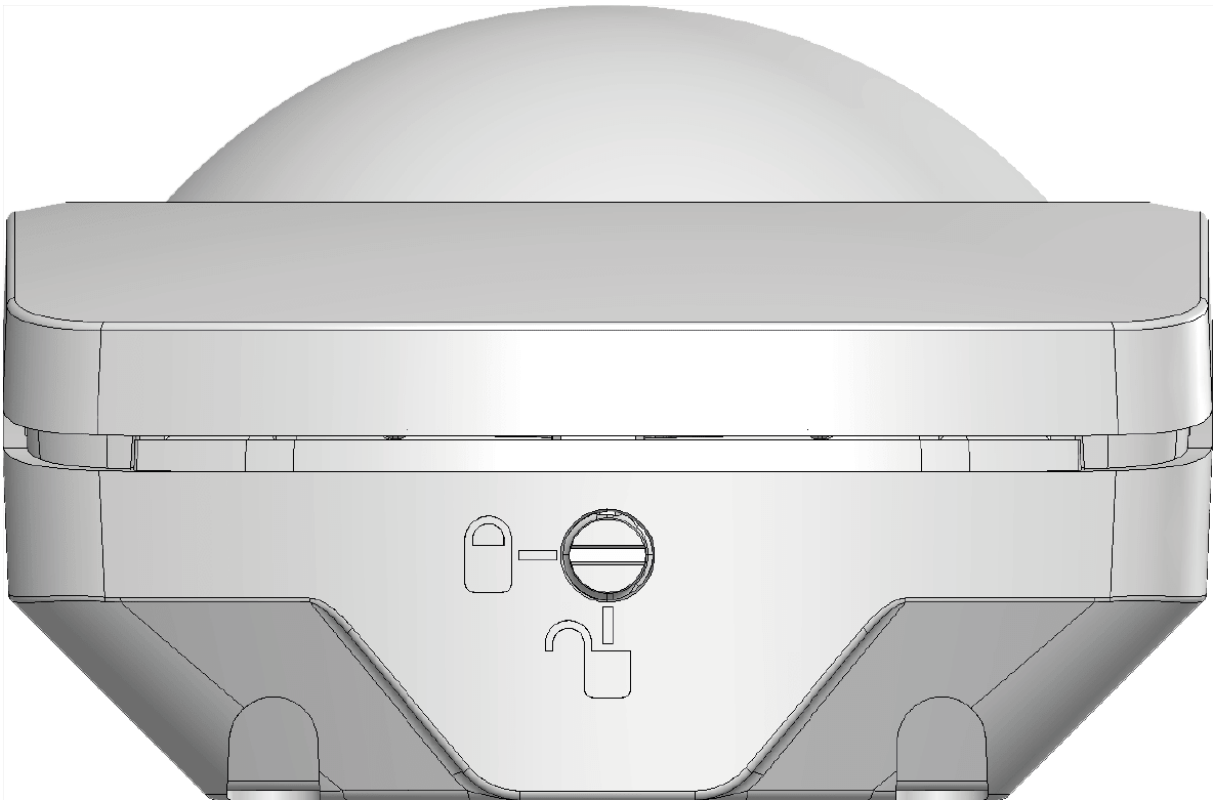

Opening the device

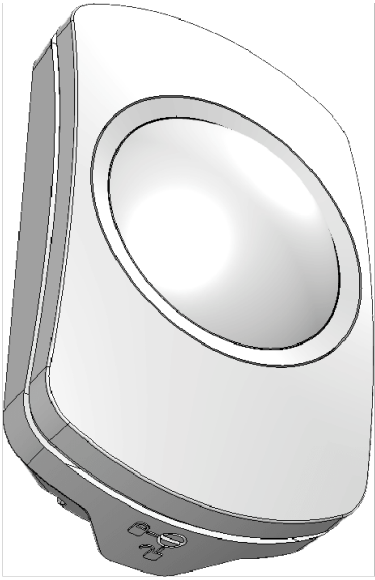

2

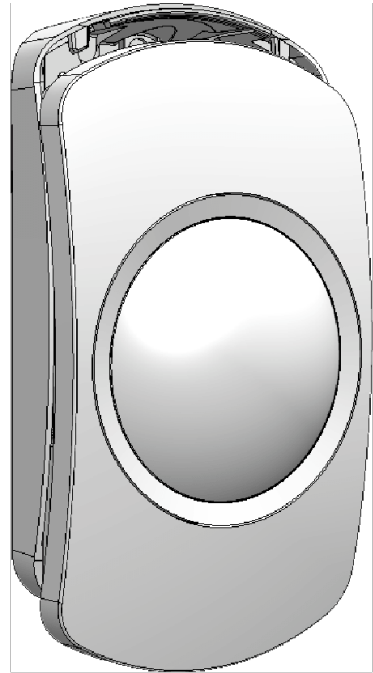

3

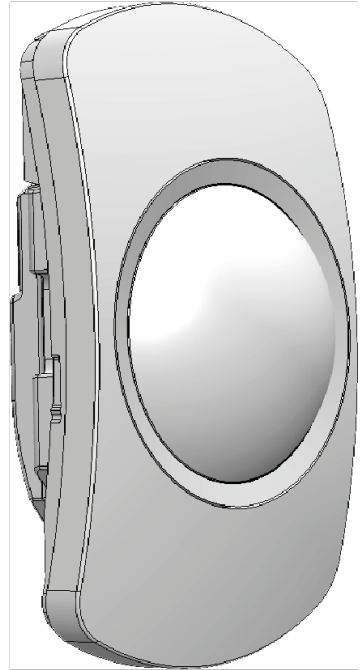
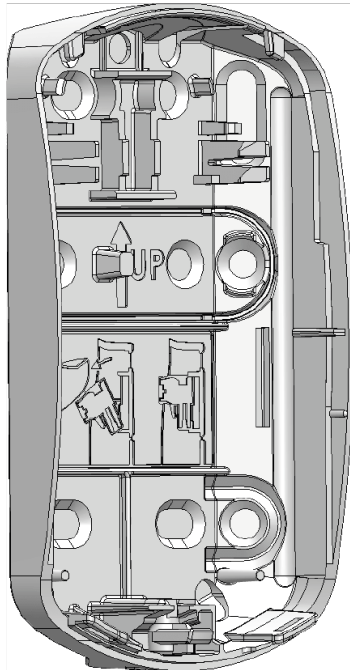

Ceiling facia removal

1 

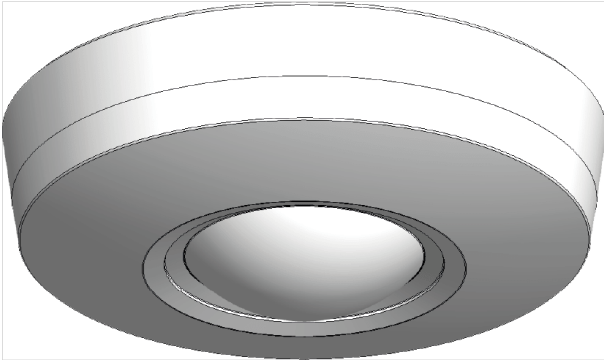

2 

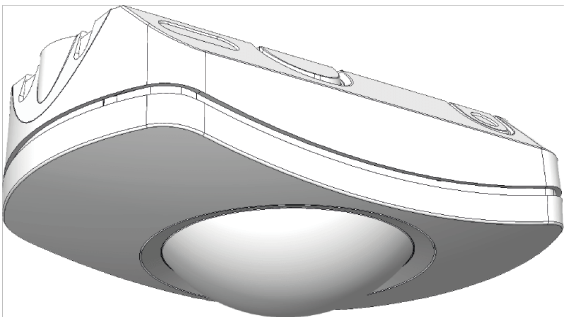
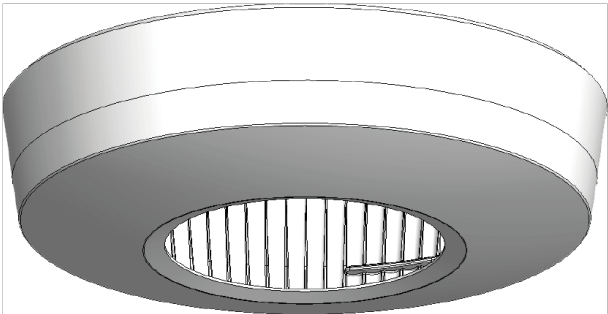

1.2 Mounting & Learning

Location

Ensure you have the correct device for the intended application, and that it is sited correctly in the desired location. The field of view should be free from obstacles and any potential false alert causes.

Devices should be mounted on stable internal surfaces and are NOT suitable for use externally.

Avoid common false alert causes

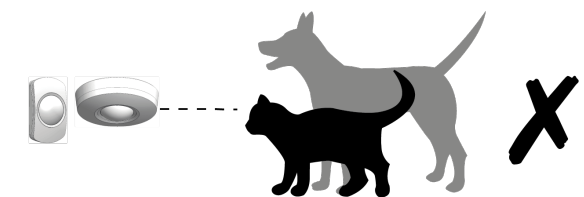
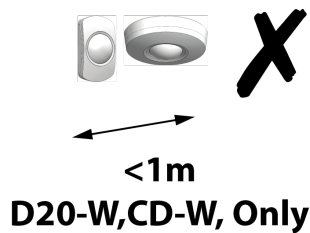
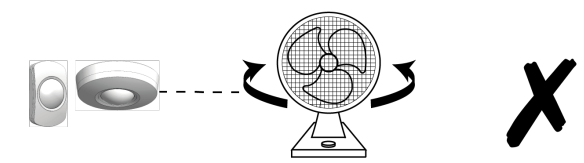
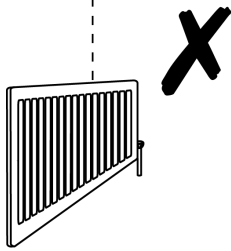
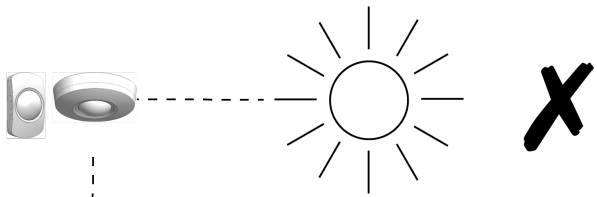
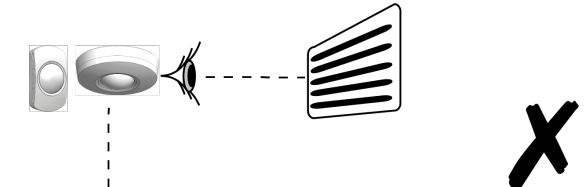
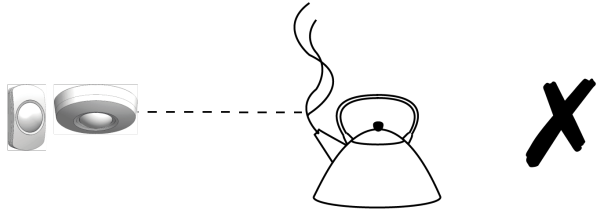
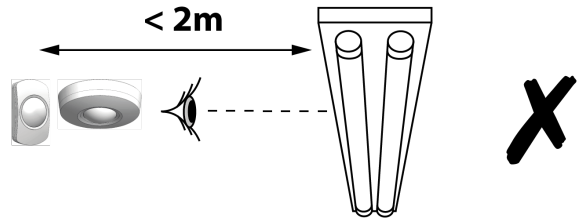
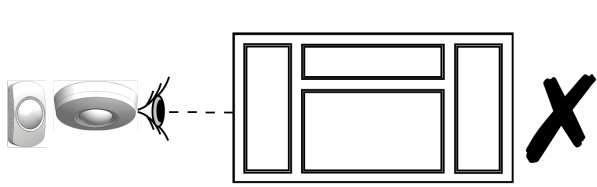

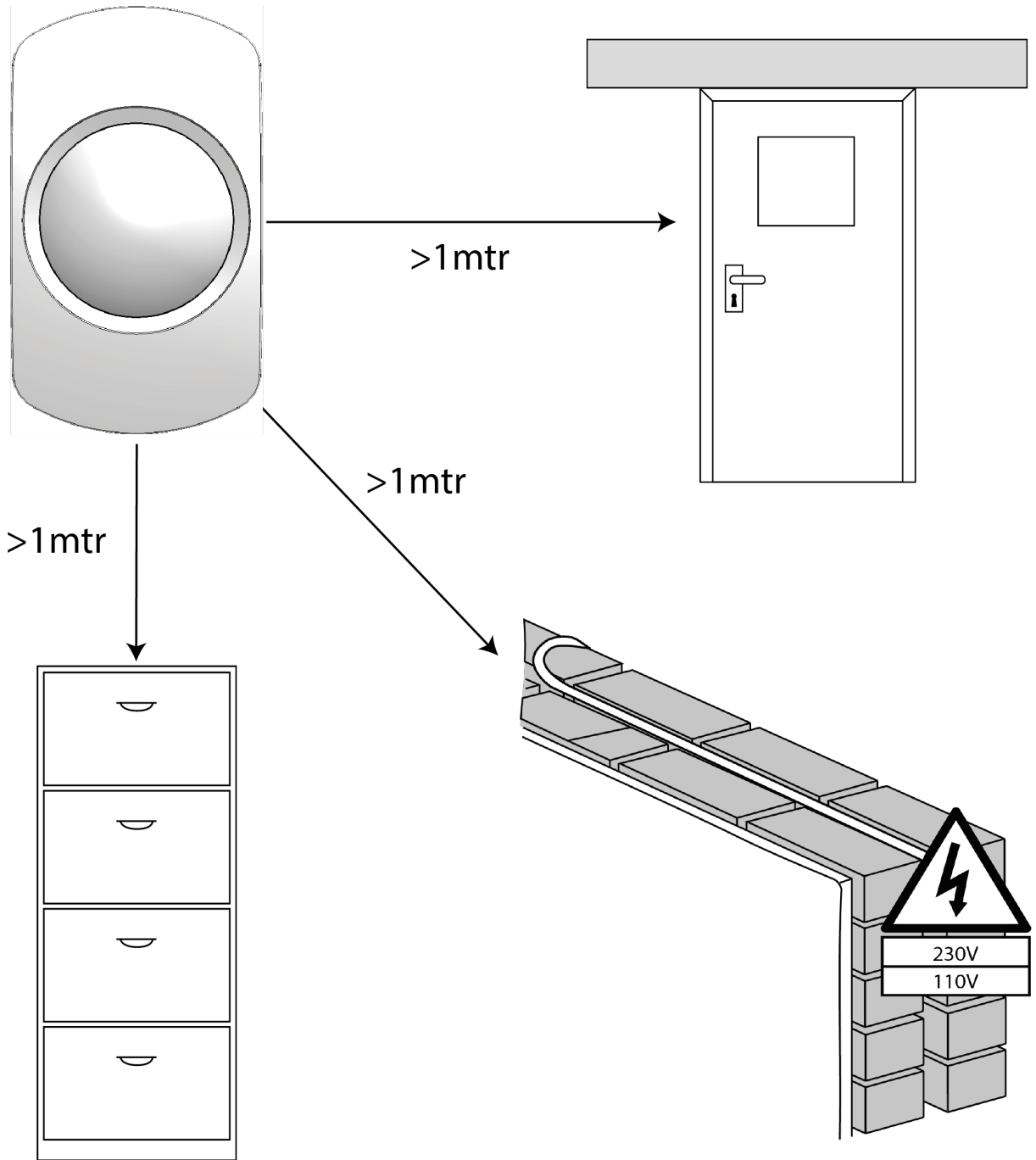

Ensure the devices field of view is not obstructed



Install on a flat stable surface only

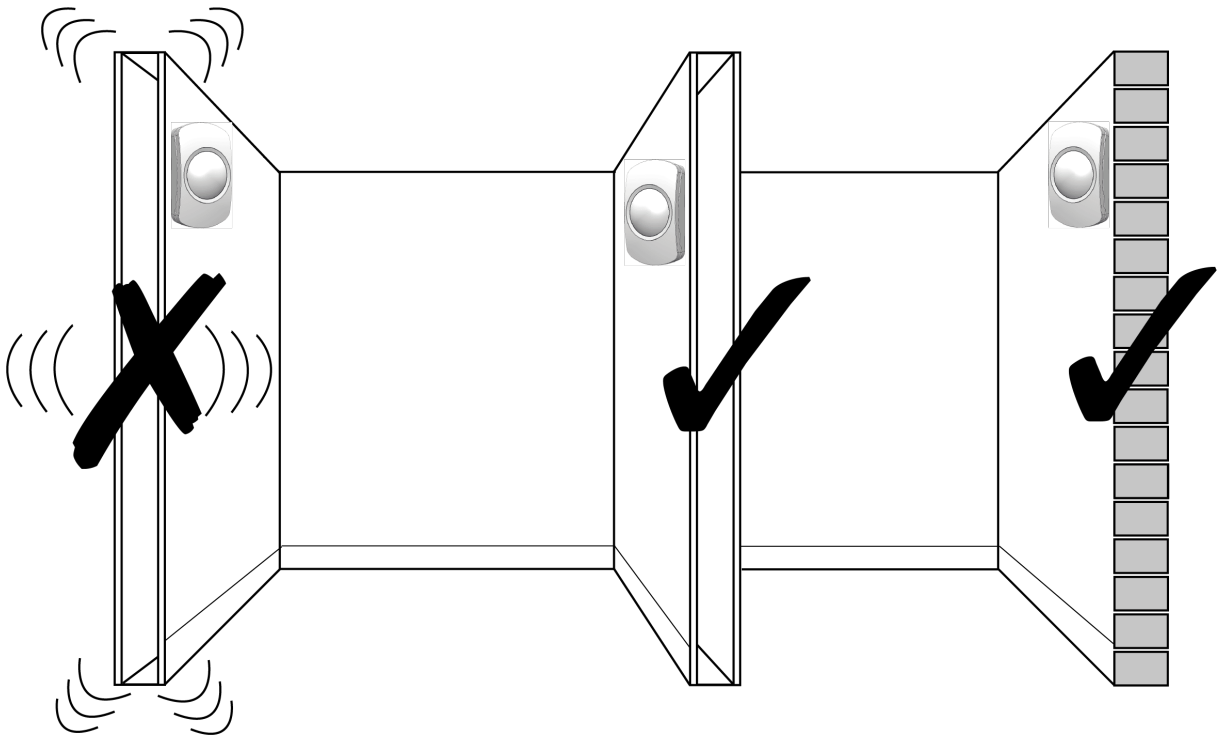

Ensure surrounding structures are stable

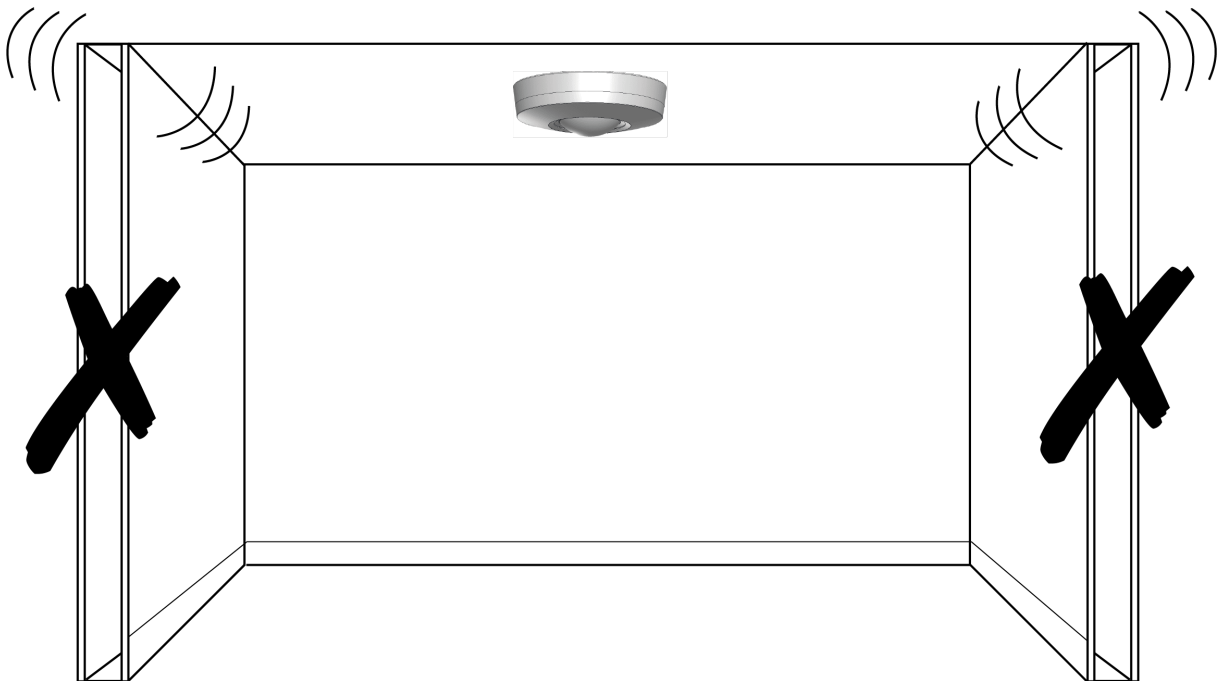

For internal use only

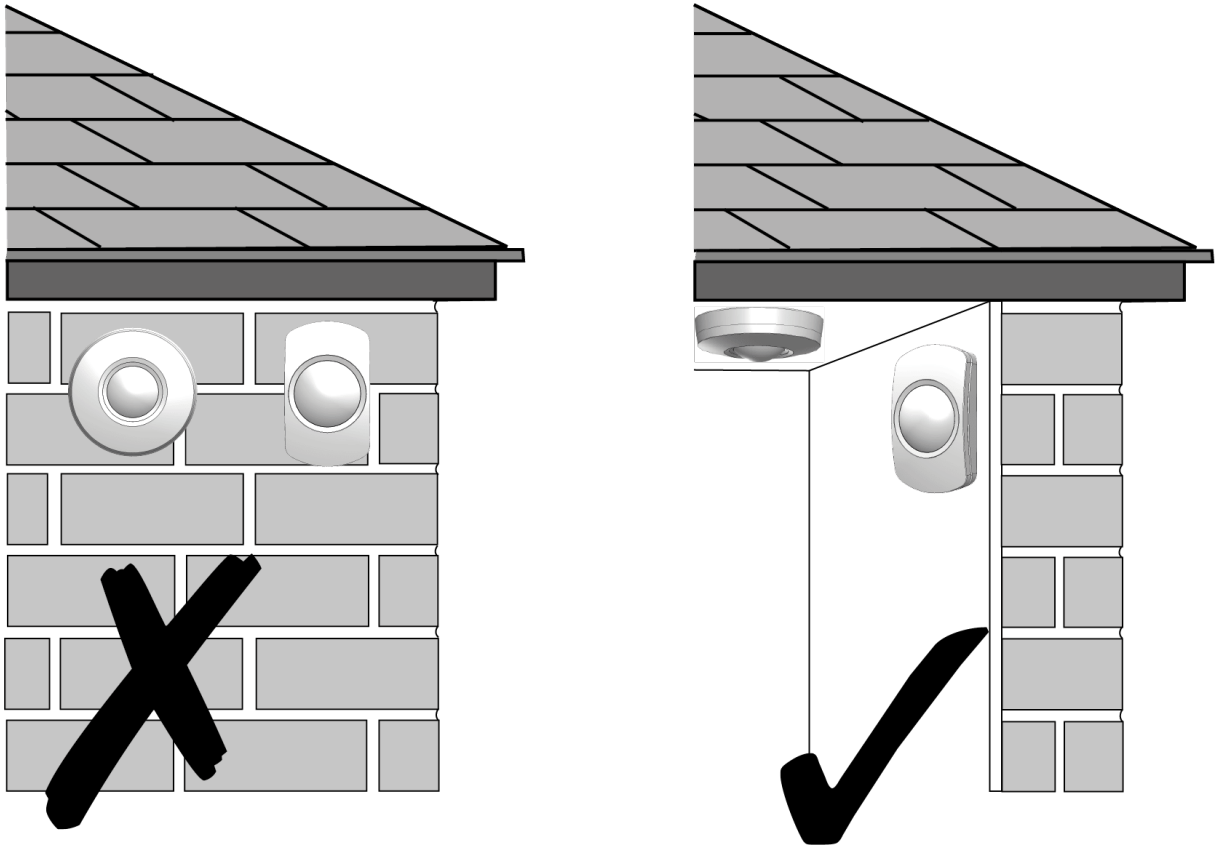

Screws & Fixings

A minimum of 2 opposing fixing holes should be used to ensure maximum stability. When corner mounting care should be taken to ensure the chassis is not twisted, if the corner is uneven then two fixings on the same side would be acceptable. Where removal from mounting detection is required you must ensure that the tamper fixing is opposite to at least one of the corner or wall fixings.

Dependent on the mounting substrate, suitable fixings may be required. The size and type will depend on the choice of fixing screw.

- Minimum screw size 3.5 X 16mm CSK
- Maximum screw size 4.0 X 70mm CSK

Learning

The device should be learned before placing in its final location.

To learn the device to the system:

- Select an empty zone slot for the device and put the system into learn mode.
- To power up insert the battery.
- The LED will flash pink while it communicates to the receiver. The LED will turn green if the device has successfully learnt onto the system. If the LED turns red the learn has failed.
- If the learn fails,
 - check the system is in learn mode.
 - move closer to the panel or expander.
 - ensure you are learning the device to an “empty” zone.

Once learned all system devices should be placed, but not fixed in the desired final location to ensure wireless performance. Devices should only be fixed when you are sure the system will perform as expected.

NOTE: The device will provide a low battery signal to the panel, once this signal is displayed the battery should be replaced within 30 days.

Corner mount

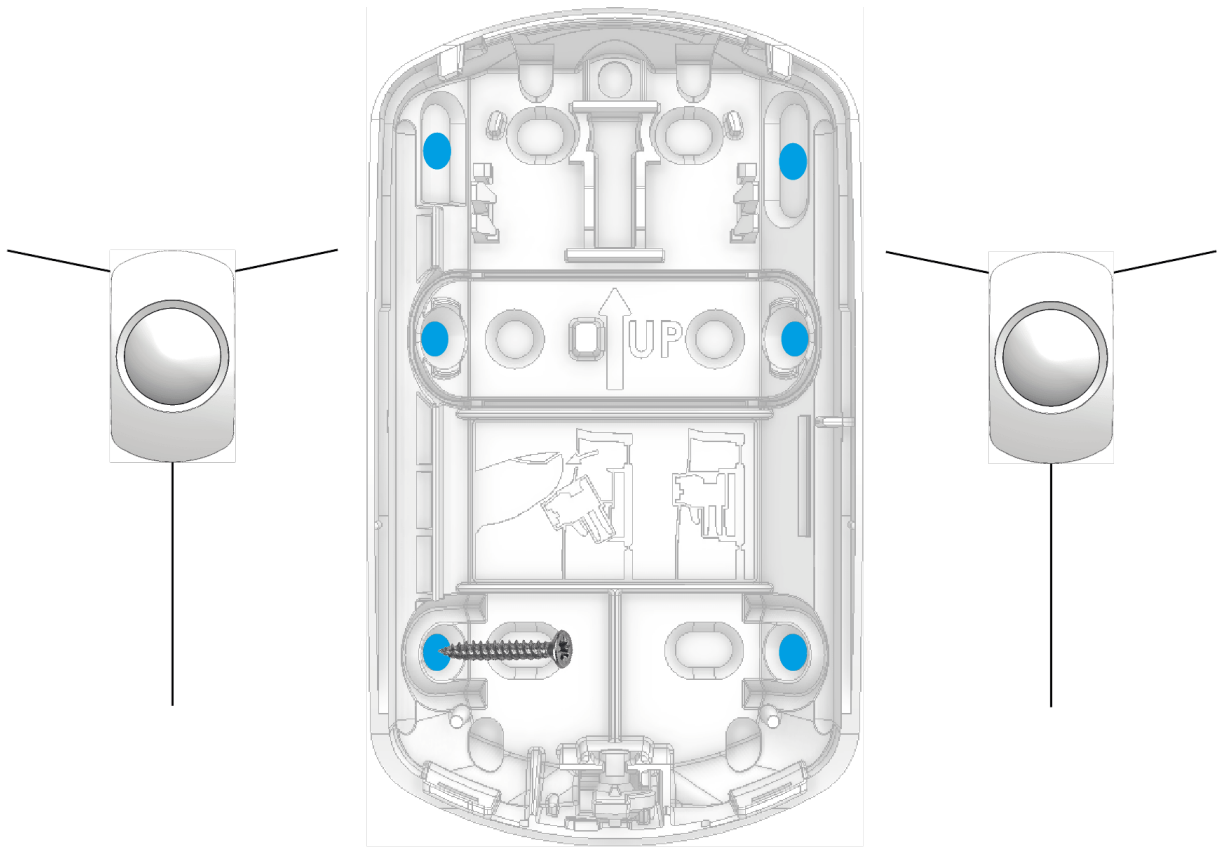

Wall, ceiling & flat surface mount

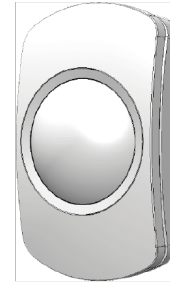
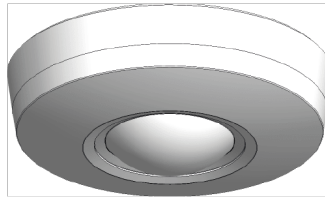
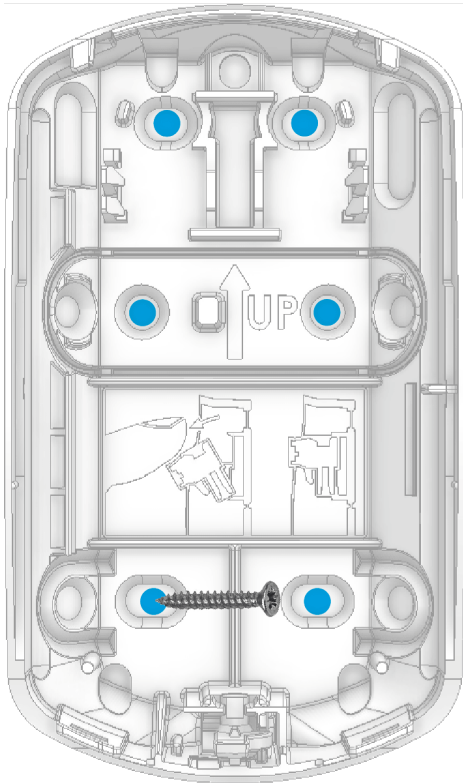

1.3 Mode selection

G2 all models (Q20-W shown)

This is the default state for optimum catch performance and false activation immunity. Switch 1 should be to the left and the lens obscuration slider should be in the down position.

- P15-W 15m @ 90° compliant to EN50131-2-2, INCERT and PD6662
- Q20-W 20m @ 90° compliant to EN50131-2-2, INCERT and PD6662
- D20-W 16m @ 80° compliant to EN50131-2-4, INCERT and PD6662

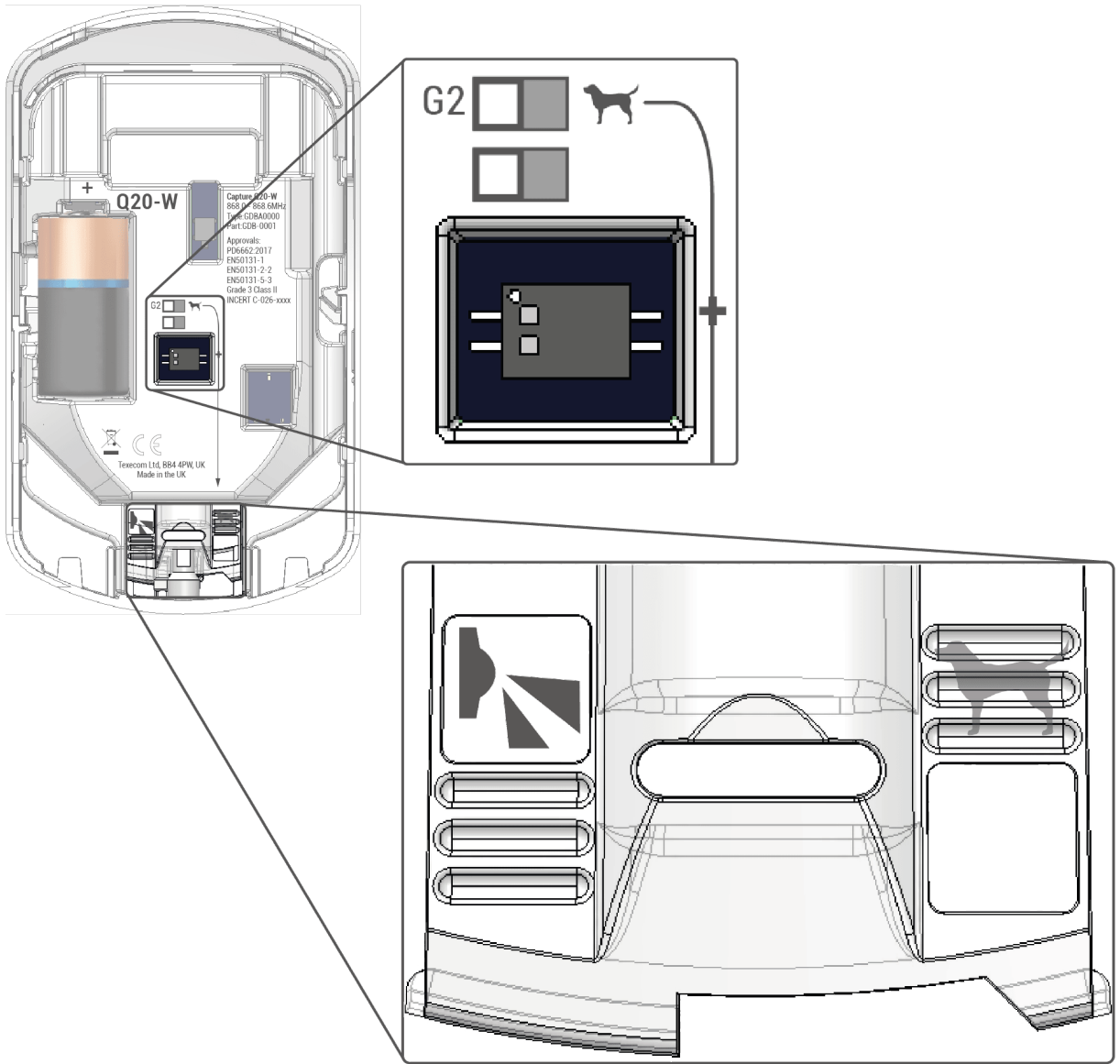

Pet Mode (P15-W, Q20-W & D20-W) NON-COMPLIANT

When using Pet mode, switch 1 should be to the right and the lens obscurity slider should both be placed in the UP position.

- P15-W 10mtr @ 90° up to 35kg pet immunity (The product is compliant with EN 50131-2-2 or EN 50131-2-4 and INCERT when in the G2 setting only.)

- Q20-W 12mtr @ 90° up to 20Kg pet immunity (The product is compliant with EN 50131-2-2 or EN 50131-2-4 and INCERT when in the G2 setting only.)
- D20-W 12mtr @ 85° up to 20Kg pet immunity (The product is compliant with EN 50131-2-2 or EN 50131-2-4 and INCERT when in the G2 setting only.)

Note: Never use CloakWise with PET mode.

NOTE: when pet mode is selected, it will be transmitted to the device within the first 3 minutes of power up. Please allow 3 minutes after pet mode is selected before performing a walk test.

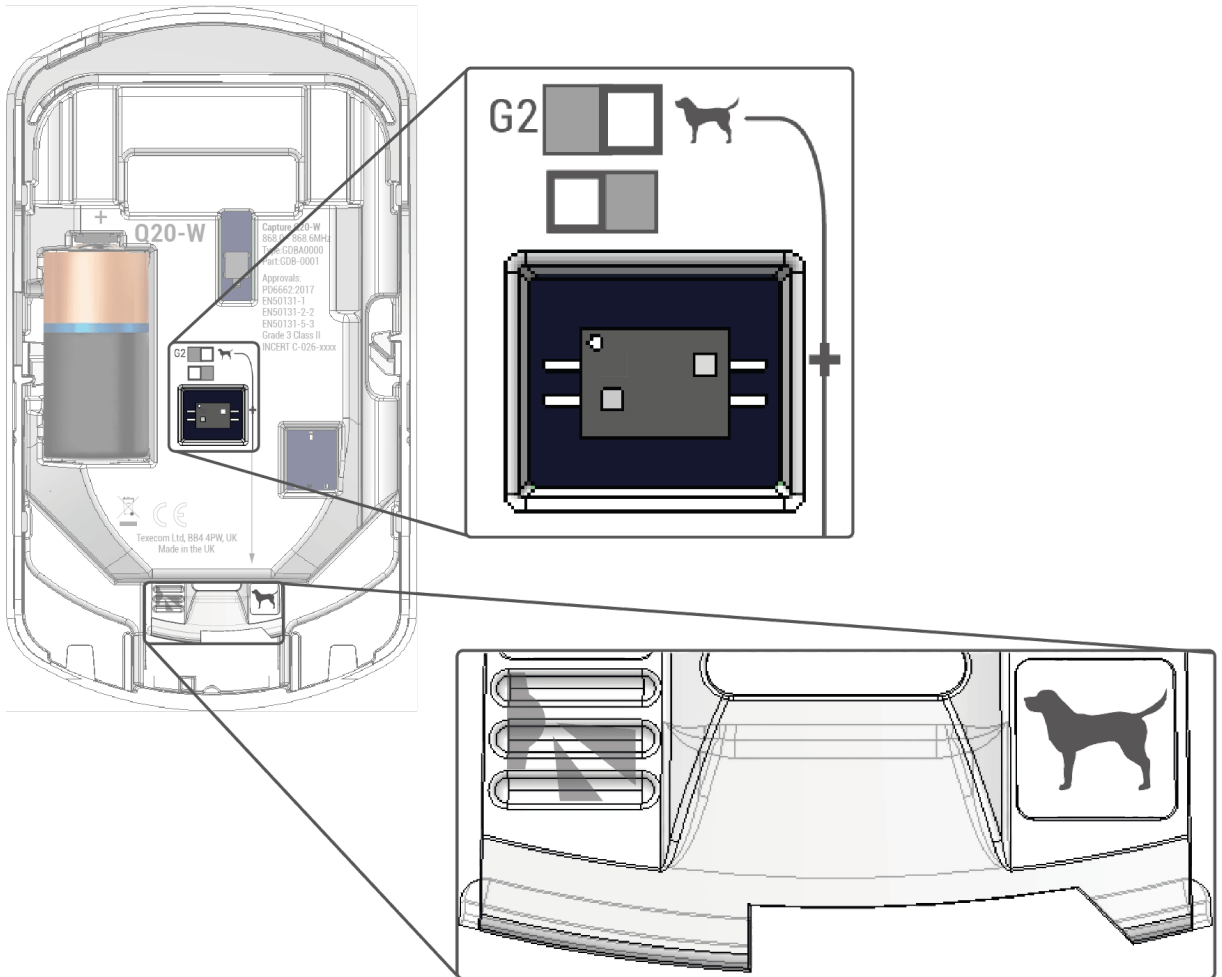

CloakWise™ D20-W & CD-W

CloakWise is a proprietary detection algorithm, unique to Telexcom, that can distinguish the presence of an intruder even if the unauthorised person attempts to mask or 'cloak' their presence. Utilising advanced signal processing techniques to both microwave and PIR channels, the CloakWise technology can recognise cloaking attempts and detect accordingly. CW mode will also provide excellent detection when the ambient temperature is close to human body temperature.

Note: Never use CloakWise with PET or LOW mode

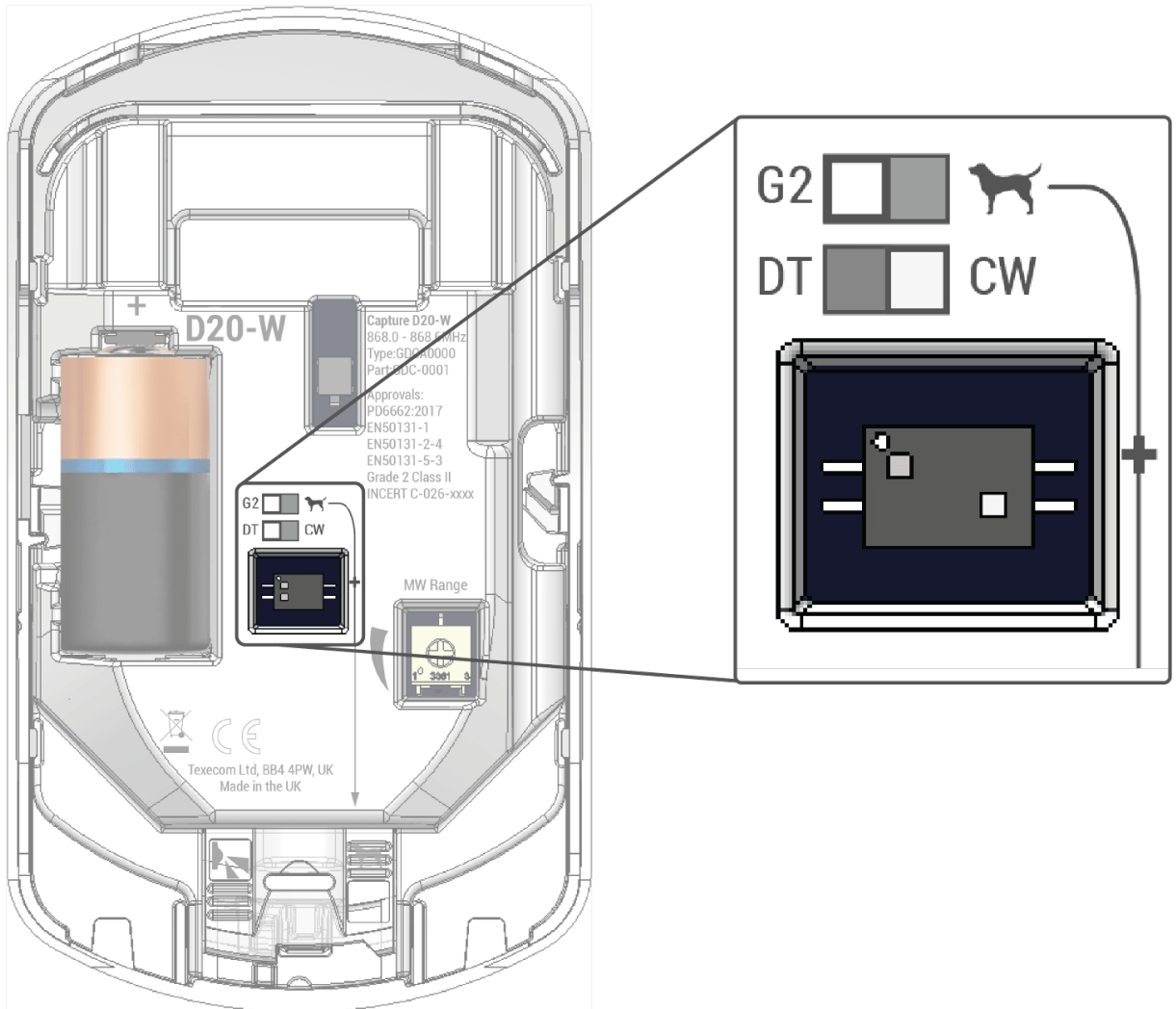

Low mode ceiling mount CQ-W & CD-W only

Low mode lowers the sensitivity of the device and provides greater false alarm immunity. Thorough walk testing across the entire protected area should be carried out to ensure catch performance is as expected.

Note: Never use CloakWise with LOW mode.

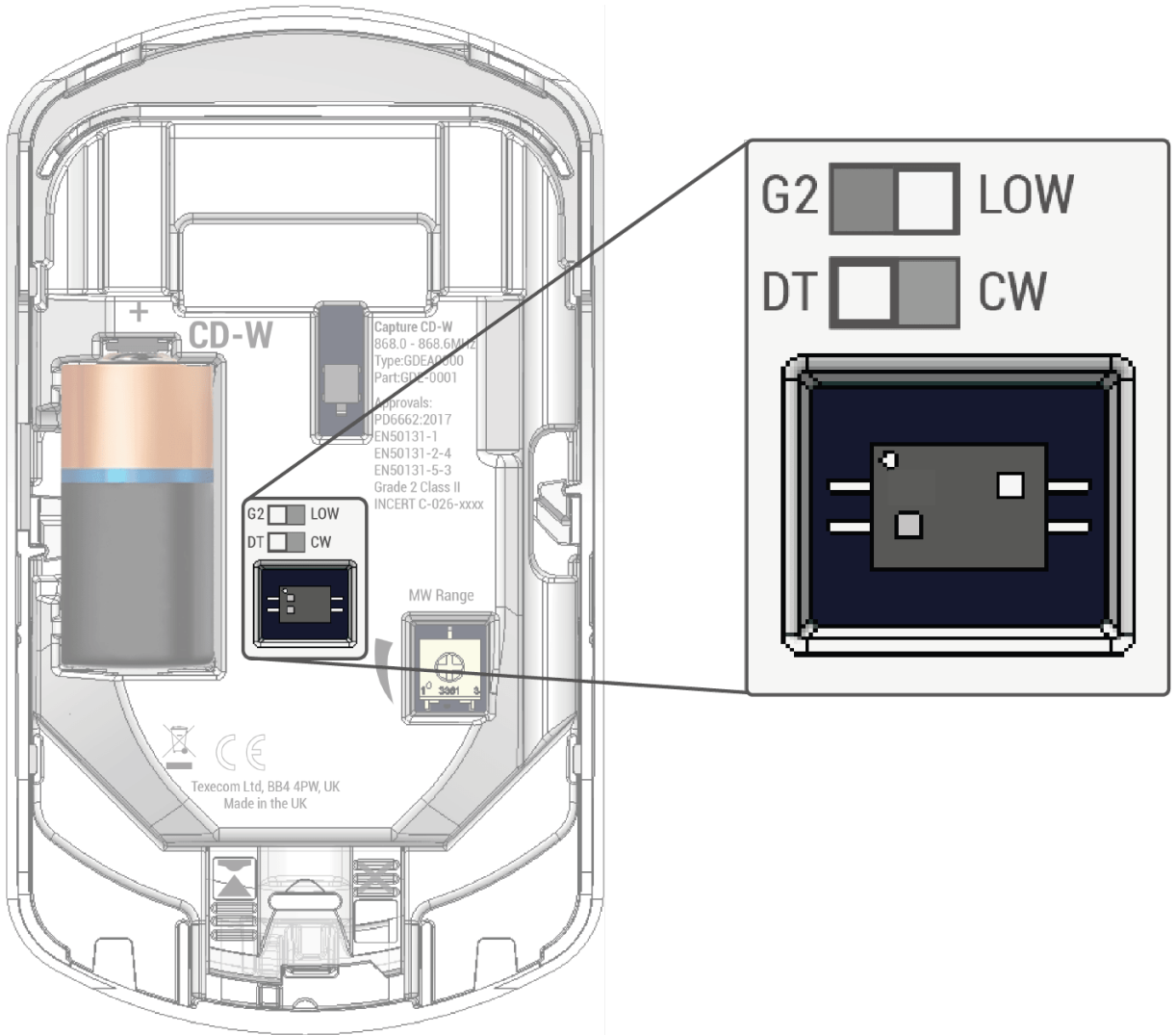

CQ-W and CD-W Slider

Leave in the default position

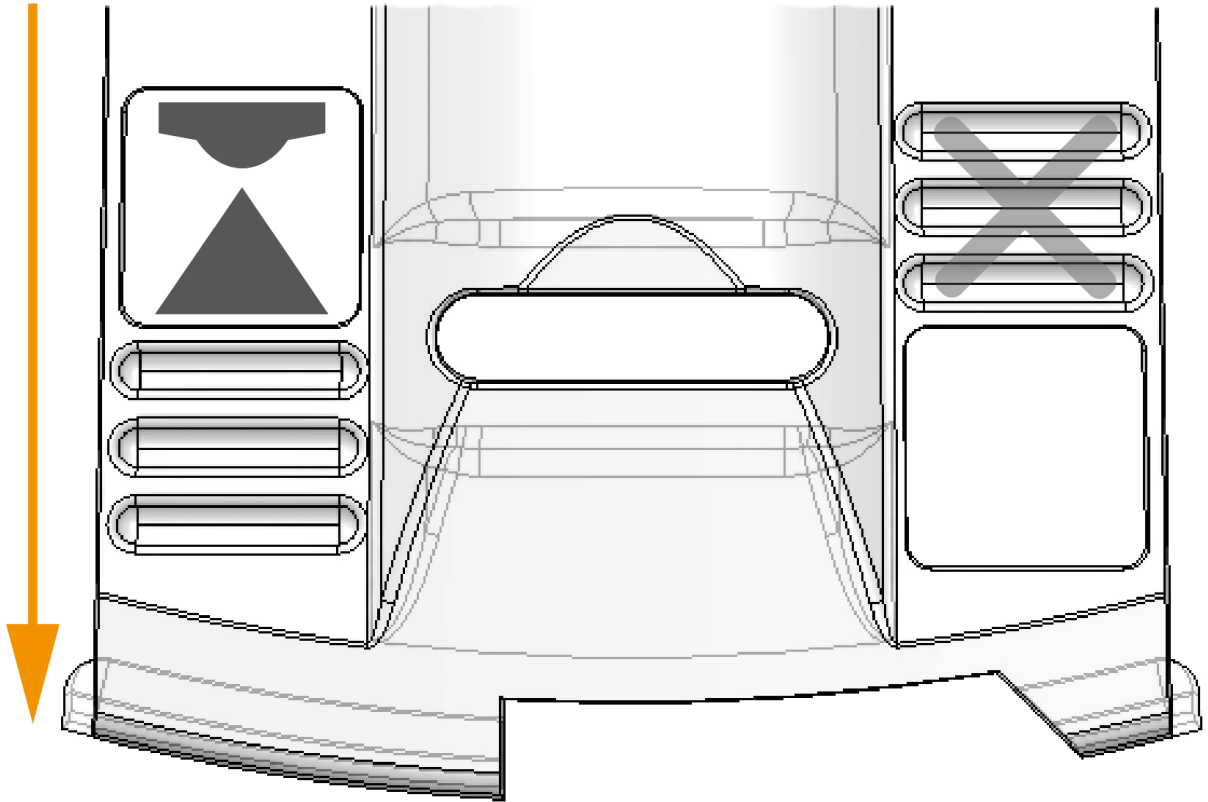

Do not use

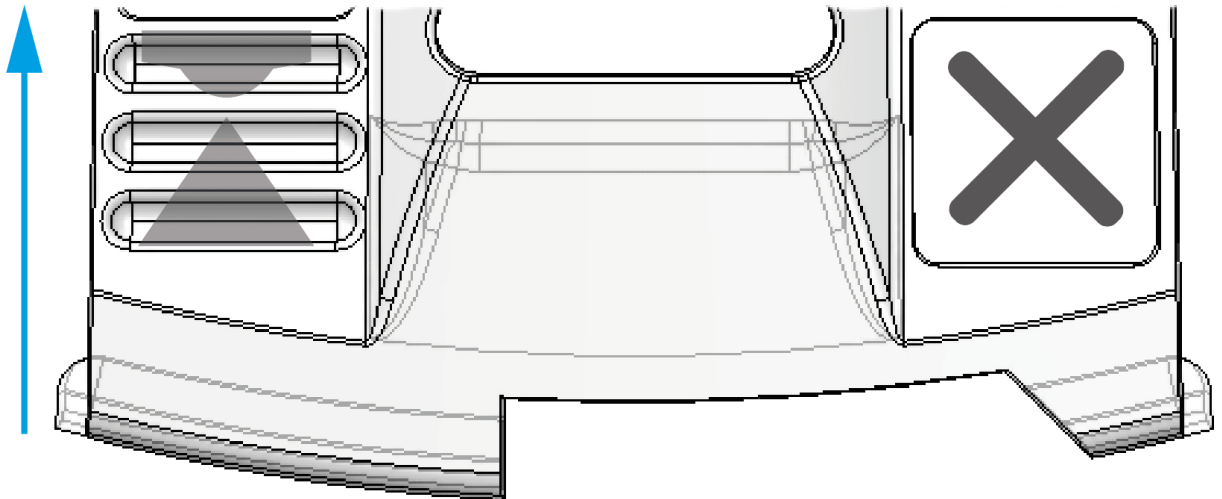

LR50 Only

MID MAX switch

Using the MID switch selection on the device reduces the range by approximately half.

LR50 Slider selection

The slider should not be used on an LR50 as it removes the creep zones. If the slider position is changed, the device should be thoroughly walk tested to ensure the protected area is not compromised.

1.4 Closing the device

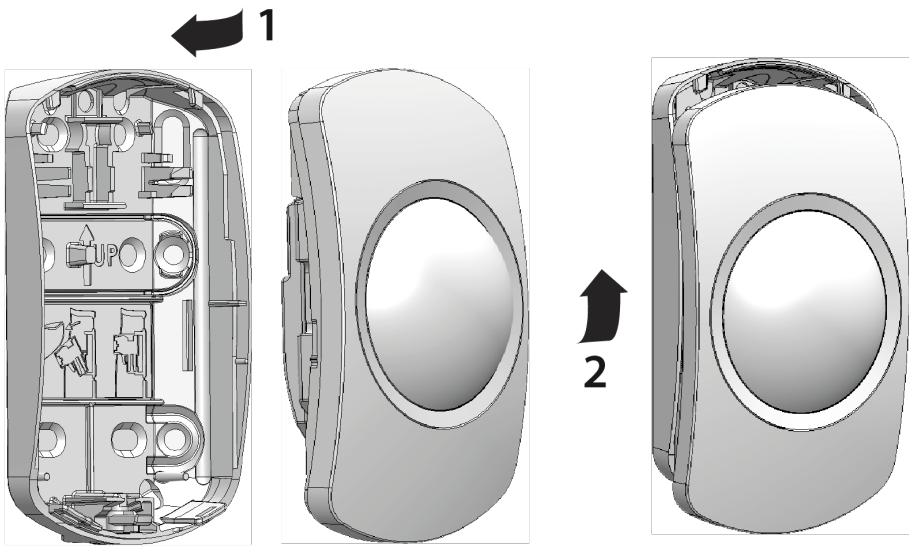

Closing the device LED indications

When closing the devices the LED will flash as follows:-







- Pink - trying to connect
- Green - connected
- Red - connection failed

When the device is closed and has successfully connected to the system it will be in walktest mode for 10 minutes.

1.5 Testing commissioning and LED indications

When installation is complete, the device should be thoroughly walk tested to ensure the desired protection is being achieved, and any adjustments to the device are made to cater for the specific location and any local site conditions.

Note: LED's are disabled during normal use. To enable the LED's put the panel into walk test mode. Devices will be in walktest mode for 10 minutes after they have been learnt to the system and the device has been closed.

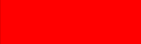
State	Colour	Flash
Warm up		Flash 0.5s on 0.5s off
Alarm		
PIR only on D20-W/CD-W		
MW only on D20-W/CD-W		
Learning		Flash fast
Learning OK		Momentary green
Learning failed		Momentary red

Walk test

Walk test all devices to ensure you have adequate coverage, and that there are no obstructions in the detection area.

D20-W & CD-W Microwave Range Adjustment

Devices are supplied with the microwave adjustment potentiometer set at the mid-point.

The microwave should be adjusted according the area to be protected, and great care should be taken to ensure the microwave cannot “see” beyond protected area. LED indication of the microwave pickup allows for accurate setting of the detection area.

- Power up the device
- Walk test the device taking note of the LED indications.

Adjust the Microwave range until the desired coverage is achieved.

D20-W Microwave Coverage

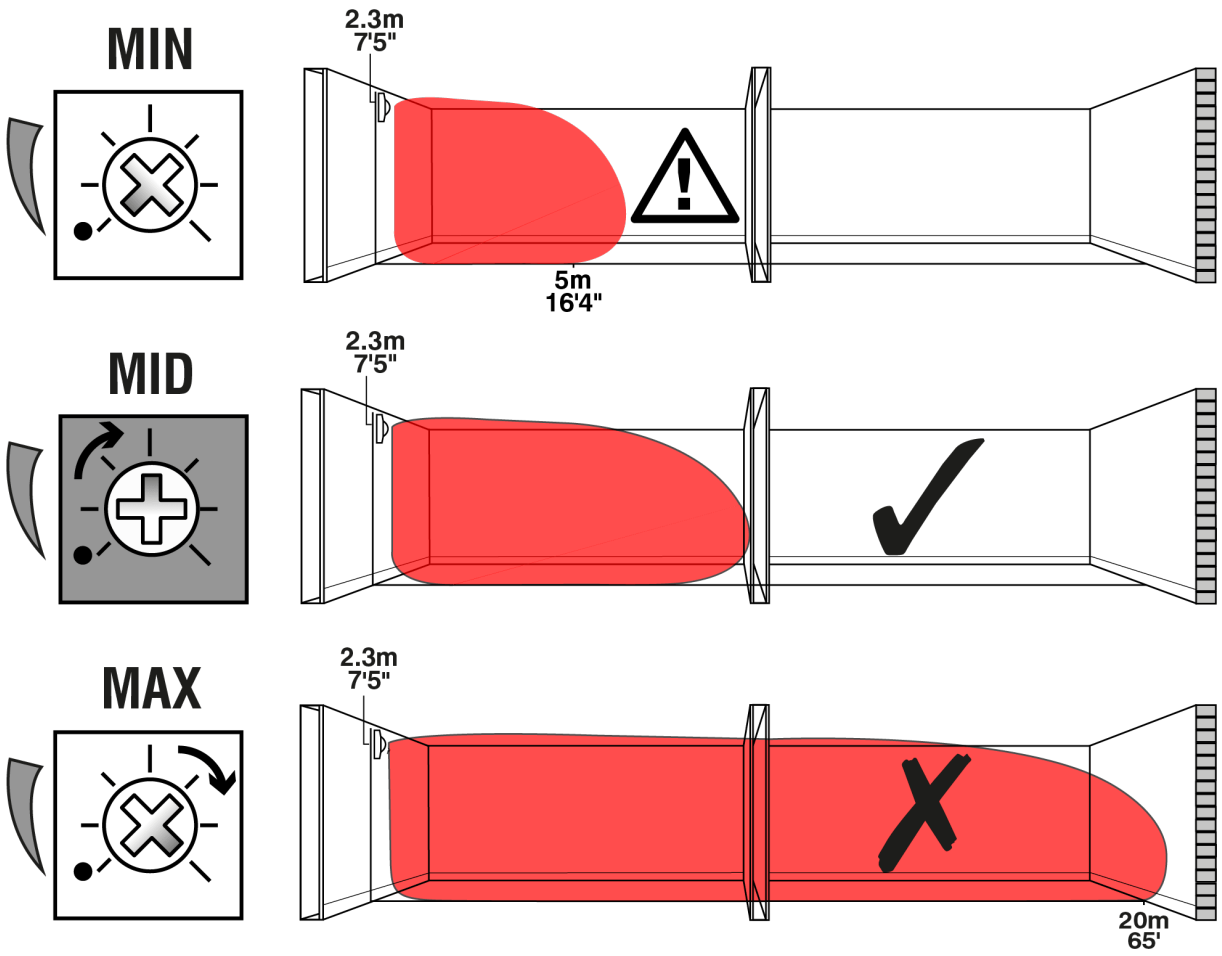

CD-W Microwave Coverage

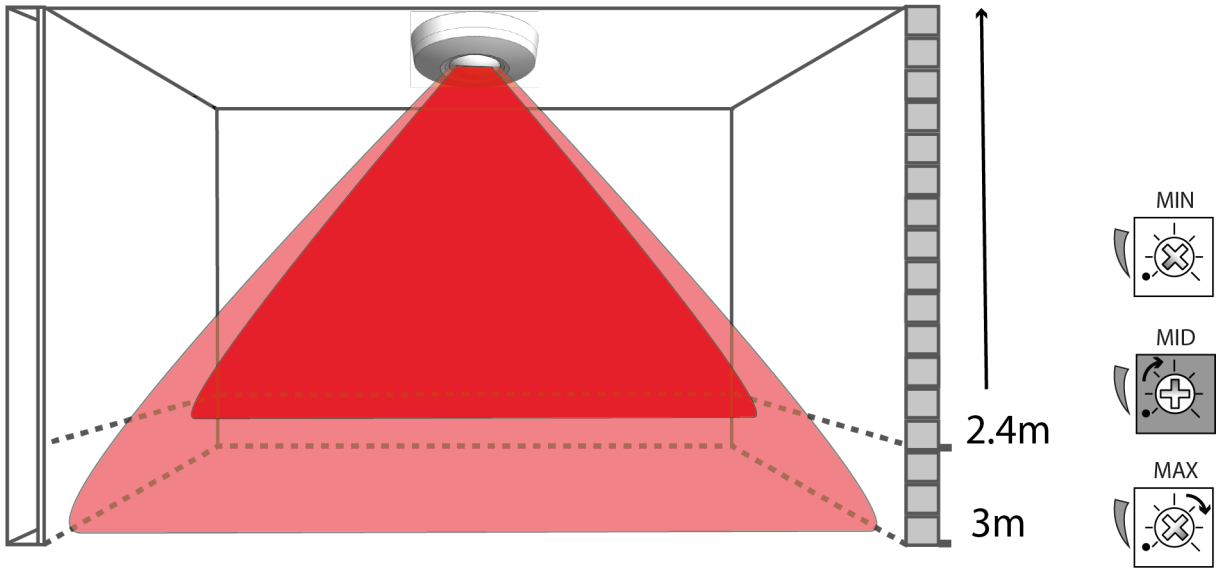

2.0 Variants

2.1 CAPTURE P15-W

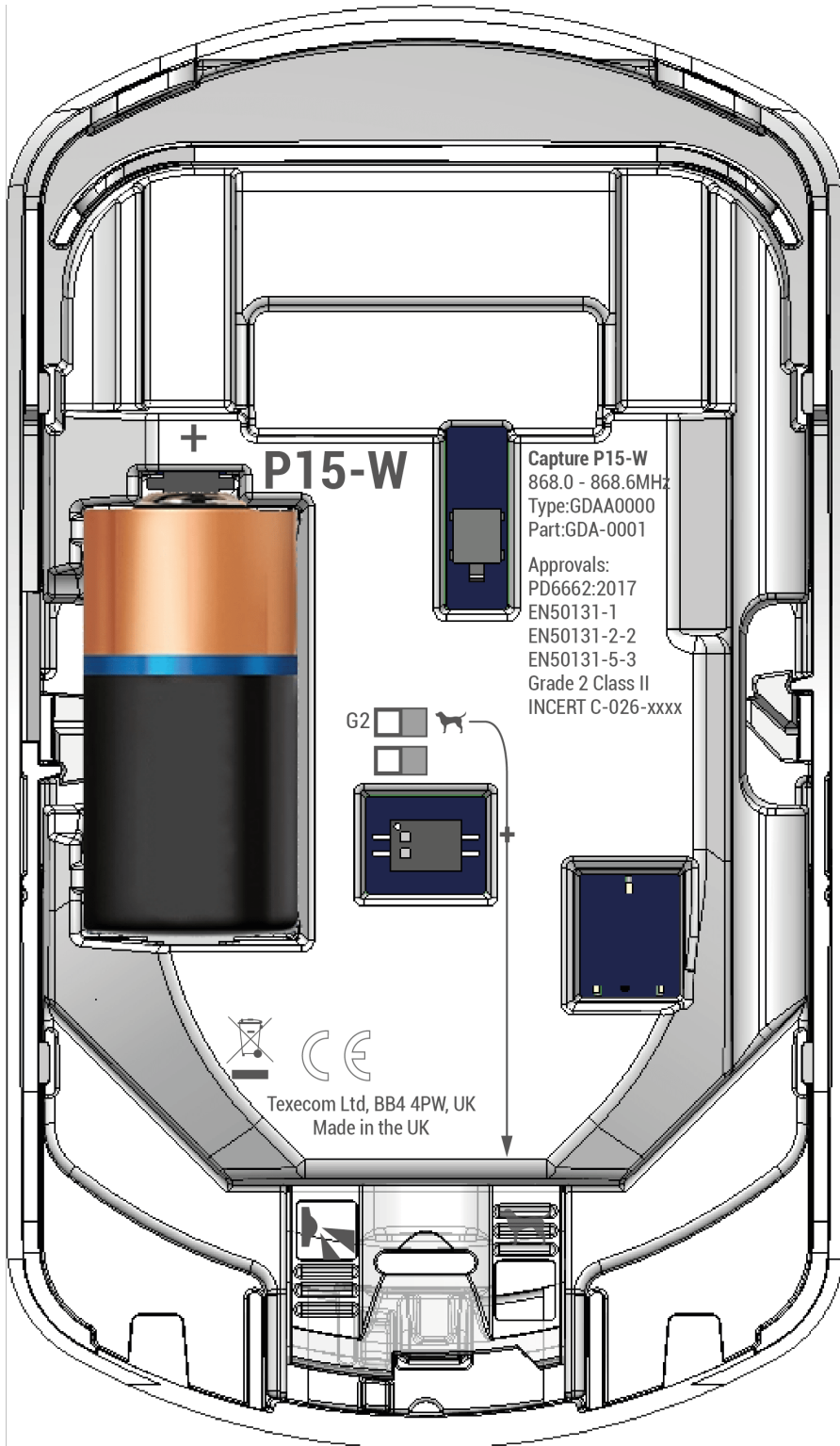

+ P15-W

Capture P15-W
868.0 - 868.6MHz
Type:GDAA0000
Part:GDA-0001
Approvals:
PD6662:2017
EN50131-1
EN50131-2-2
EN50131-5-3
Grade 2 Class II
INCERT C-026-xxxx

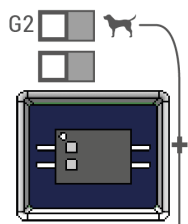

Texcom Ltd, BB4 4PW, UK
Made in the UK

G2 Coverage

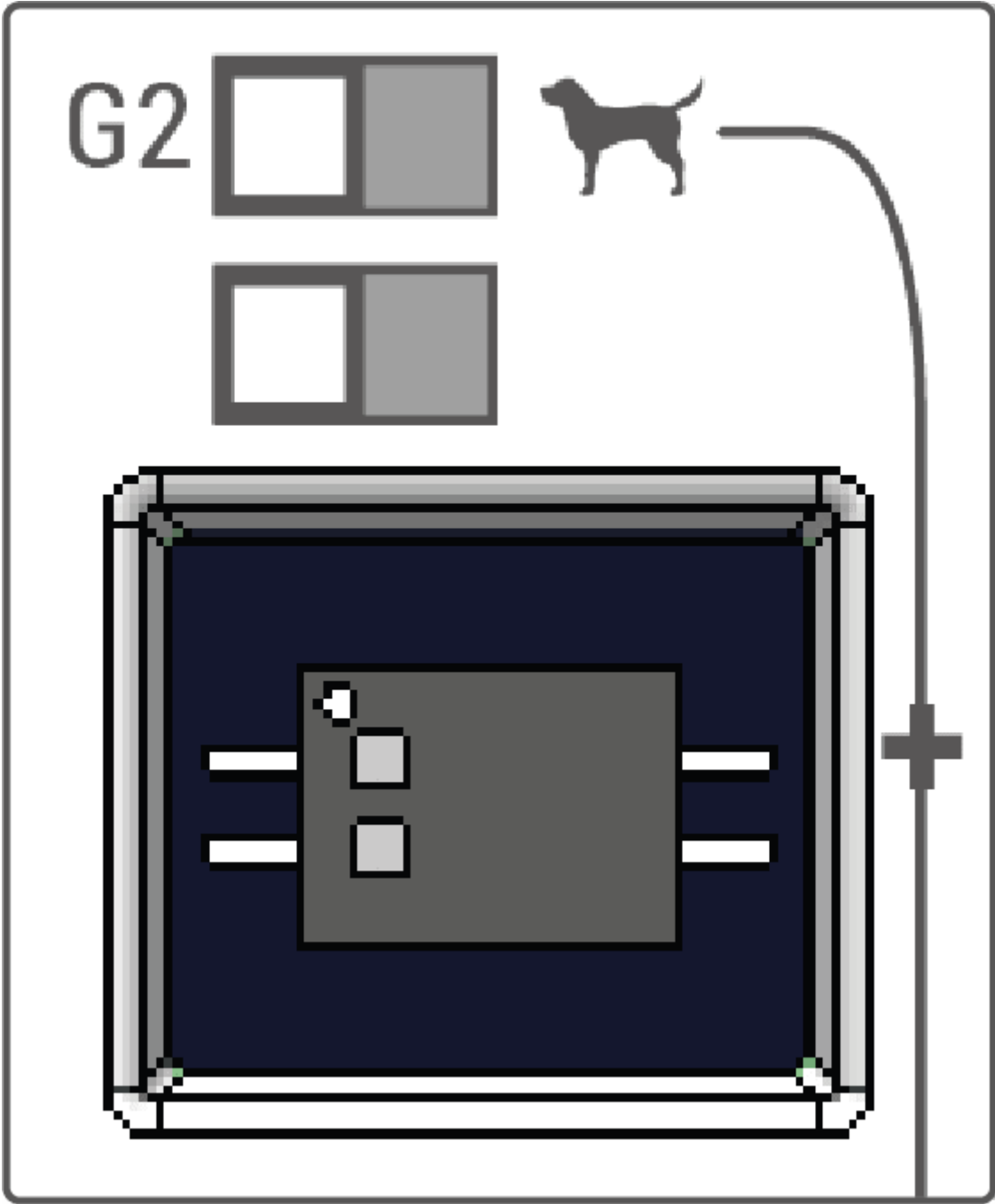

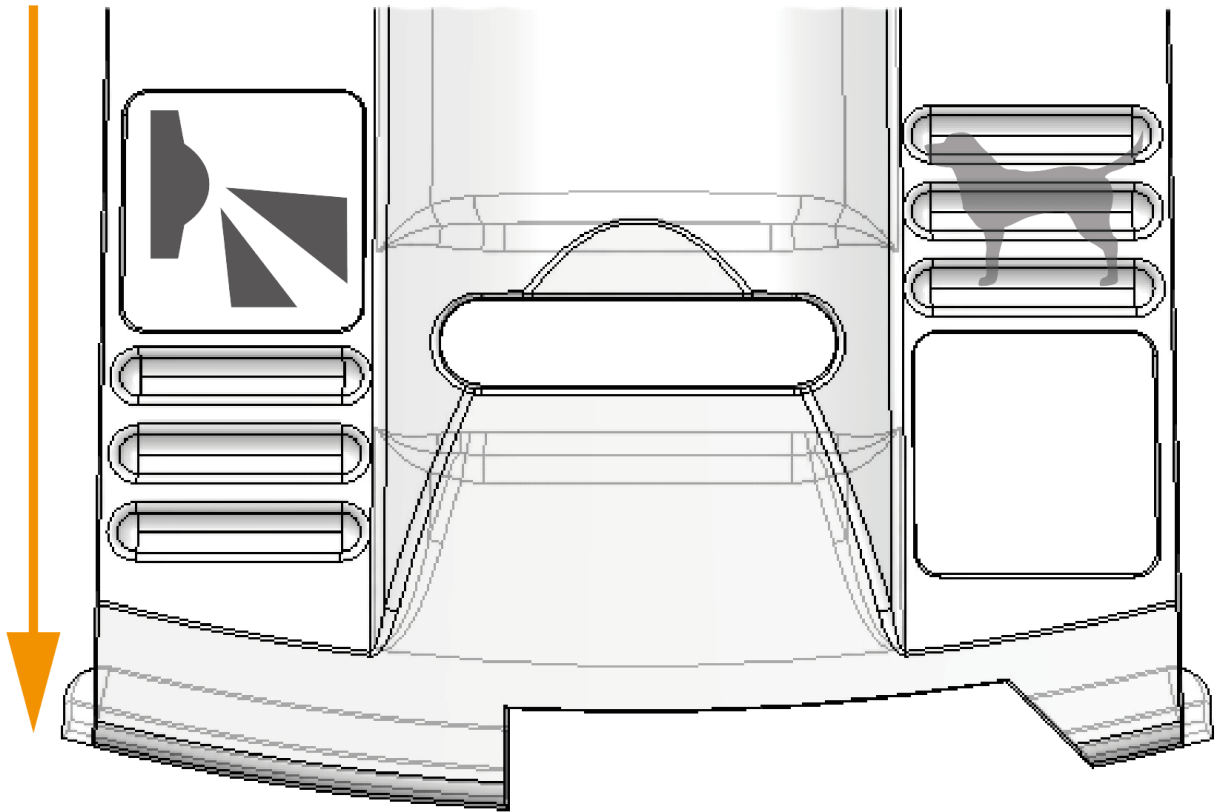

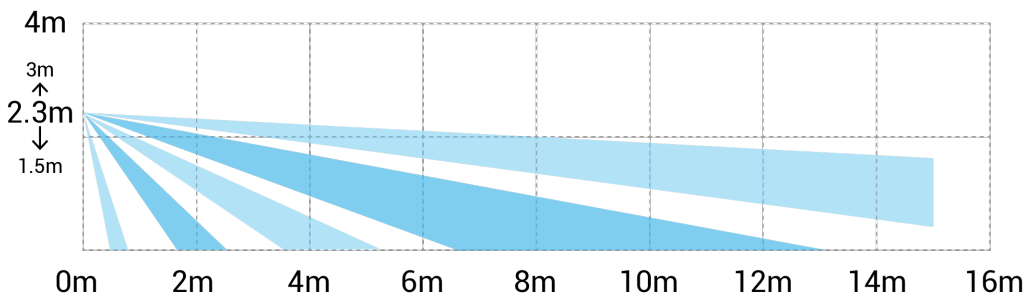
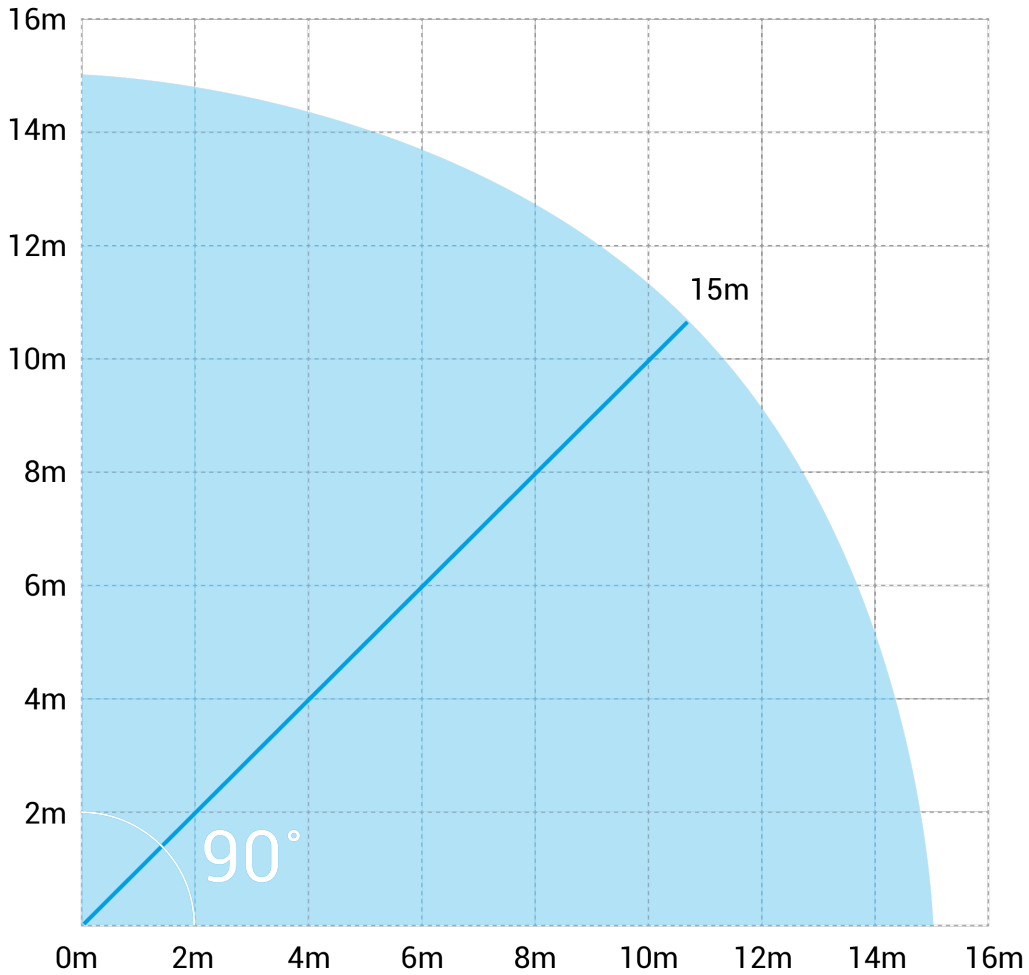

Pet Coverage (The product is compliant with EN 50131-2-2 or EN

50131-2-4 and INCERT when in the G2 setting only)

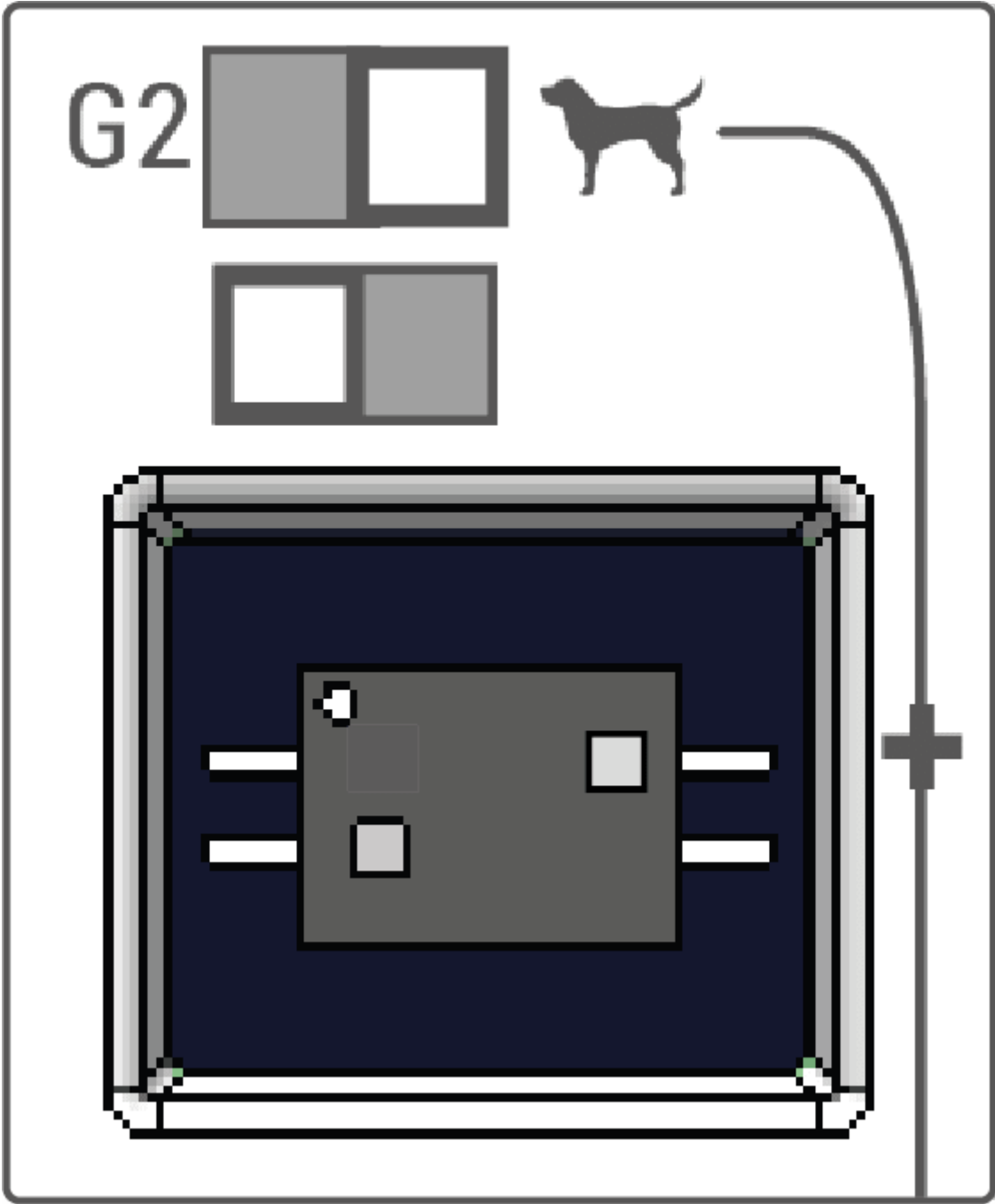

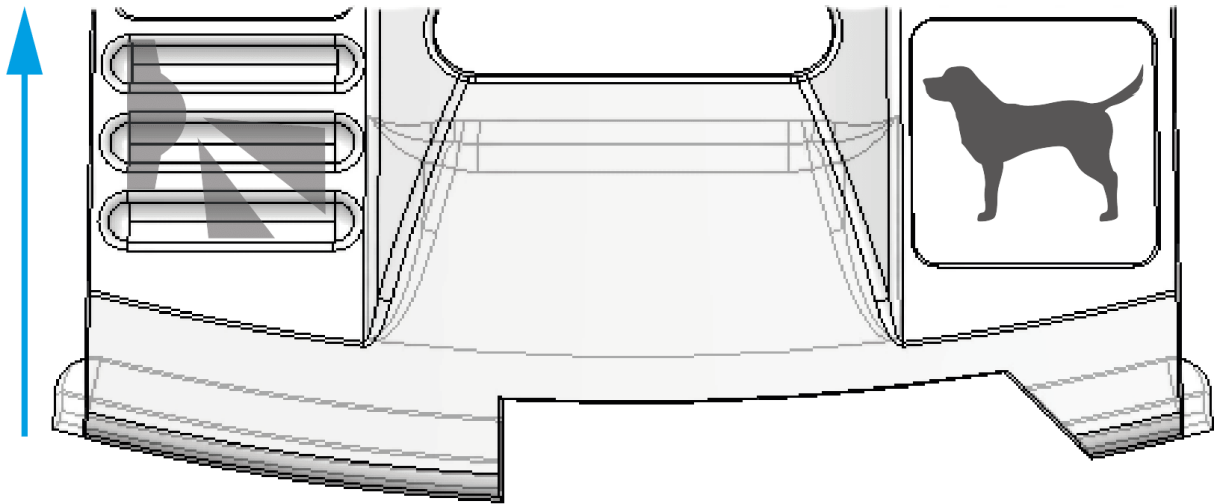

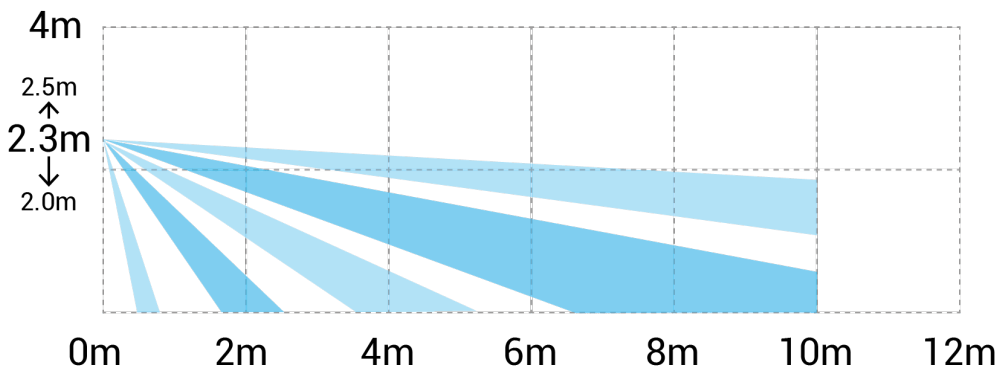
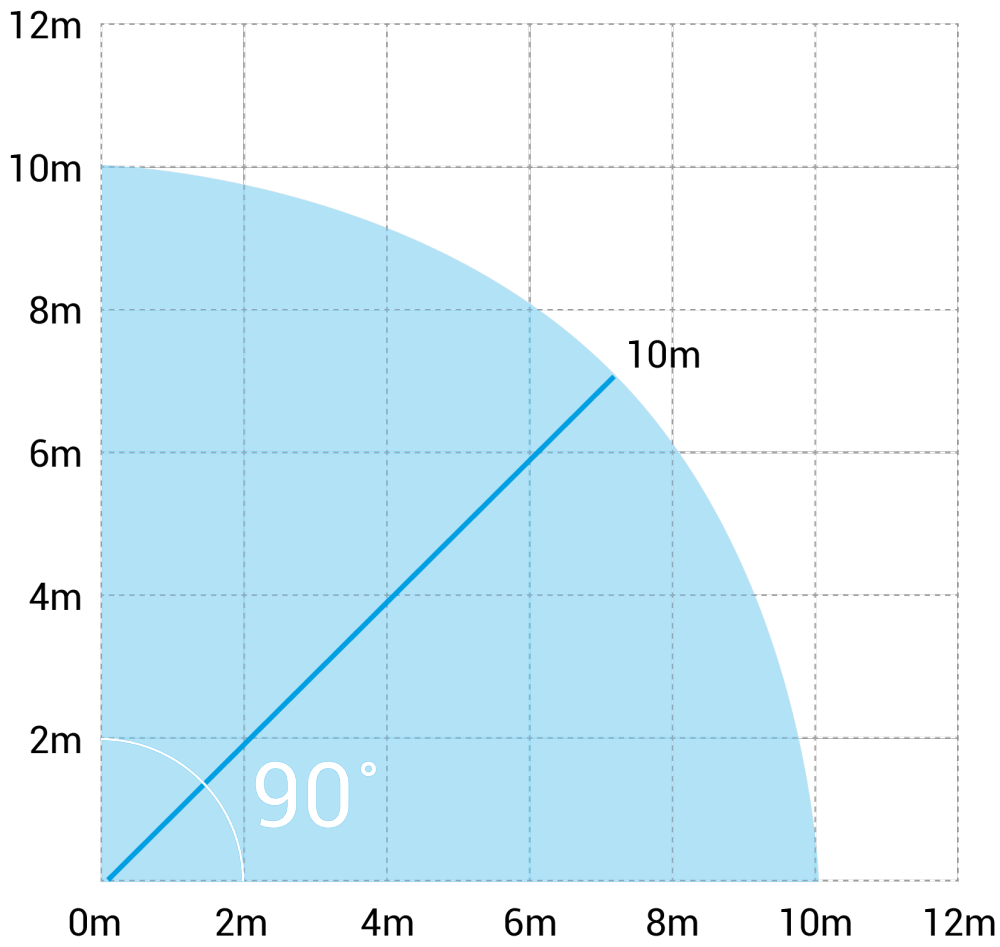

2.2 CAPTURE Q20-W

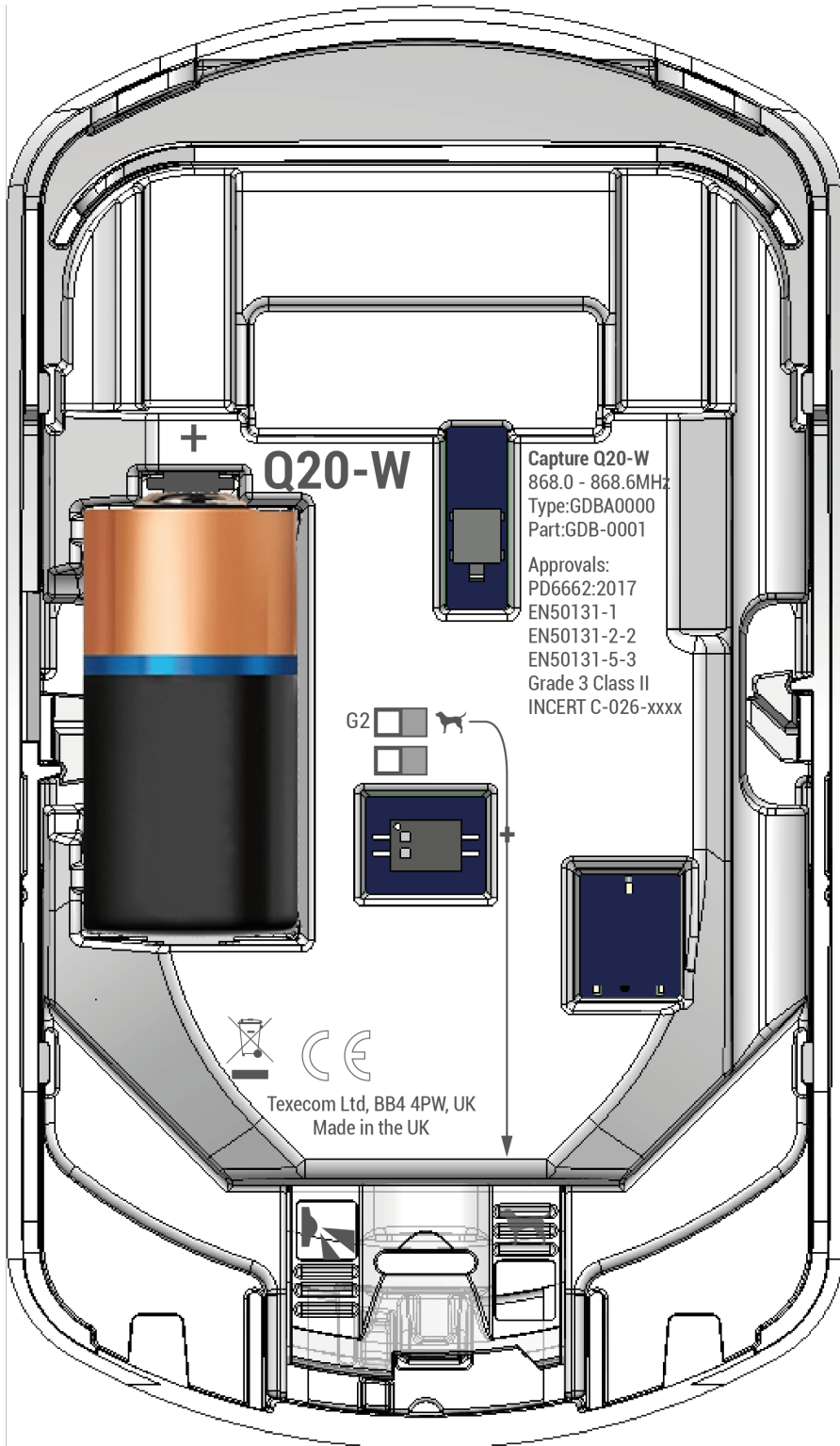

G2 Coverage

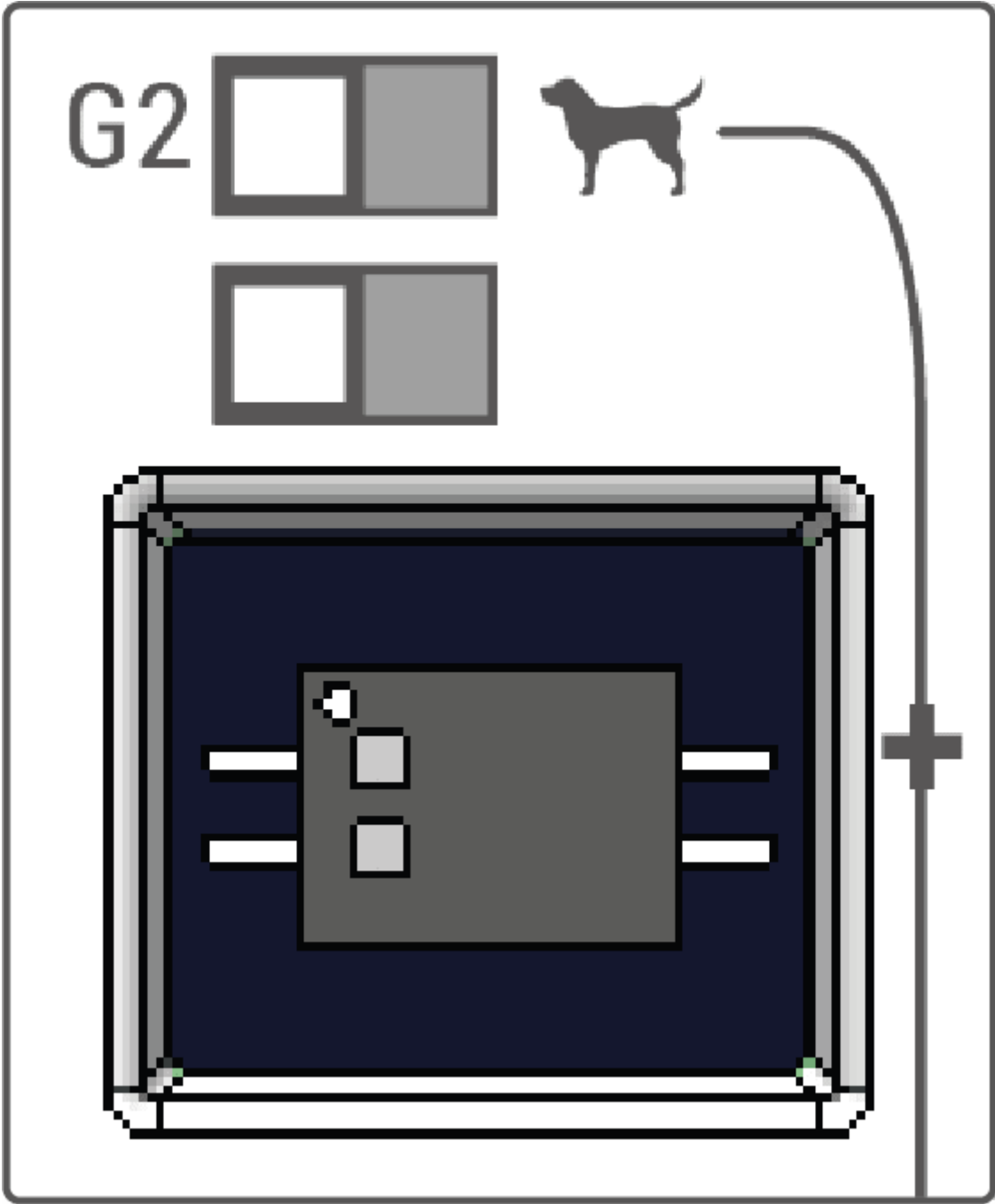

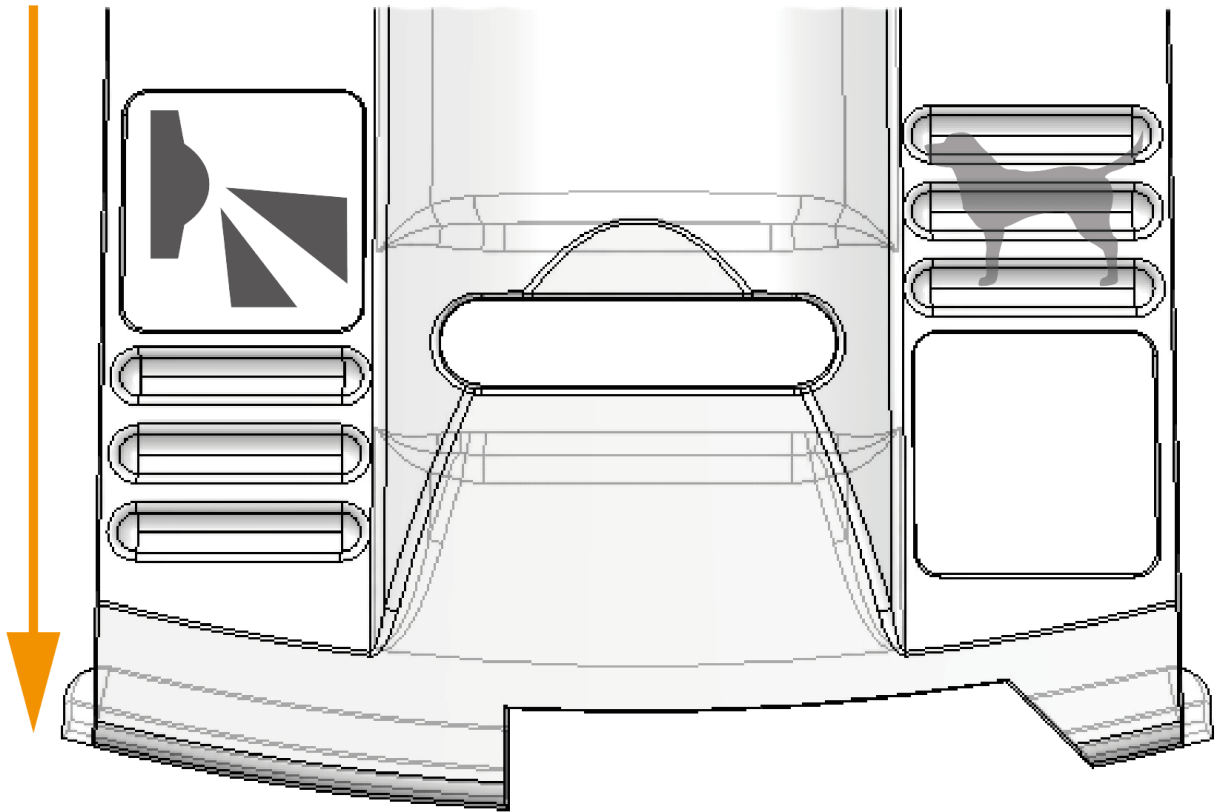

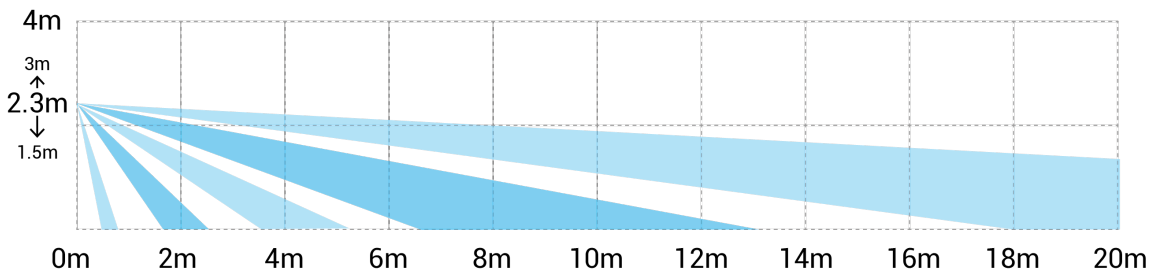
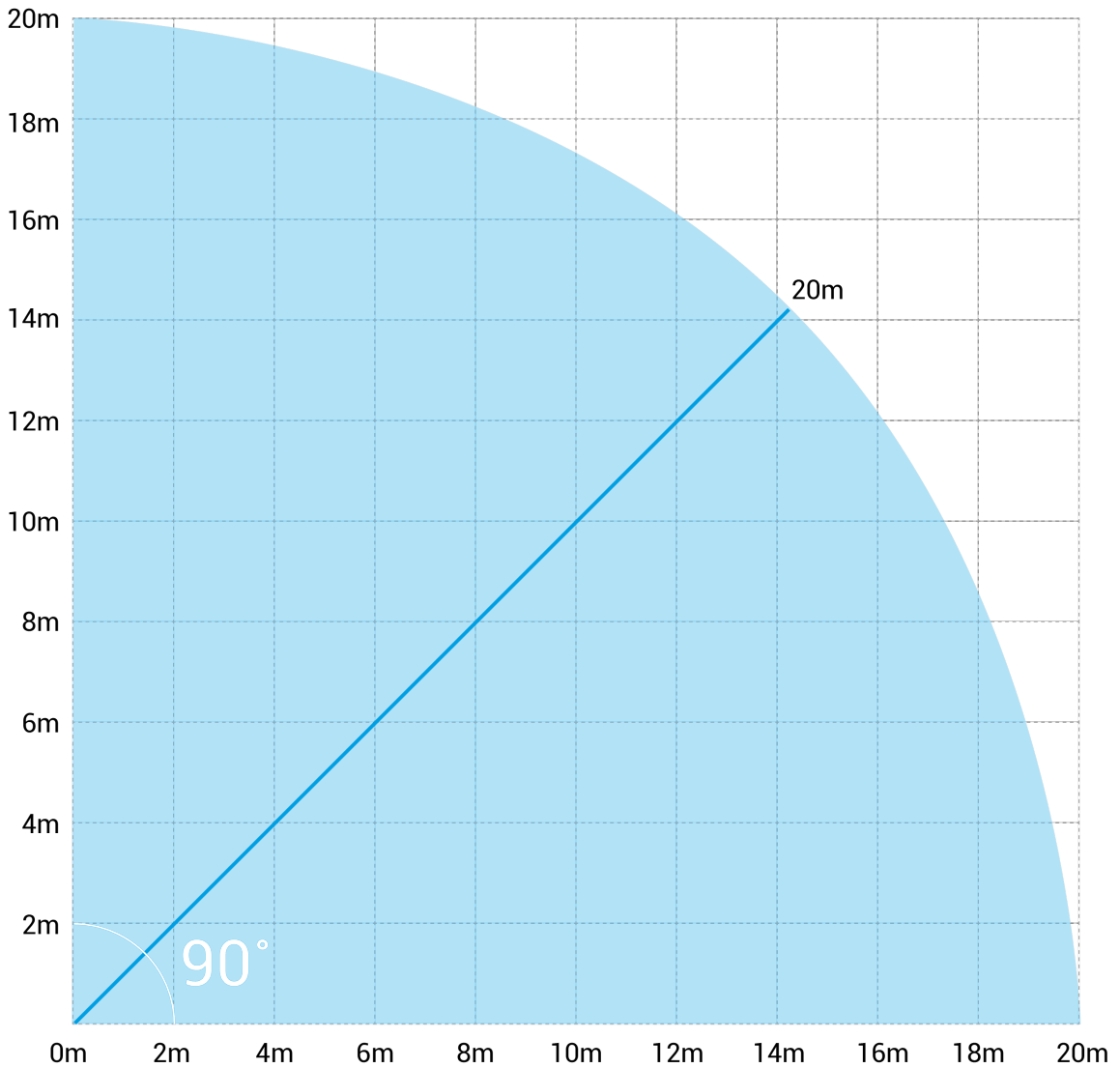

Pet Coverage (The product is compliant with EN 50131-2-2 or EN 50131-2-4 and INCERT when in the G2 setting only.)

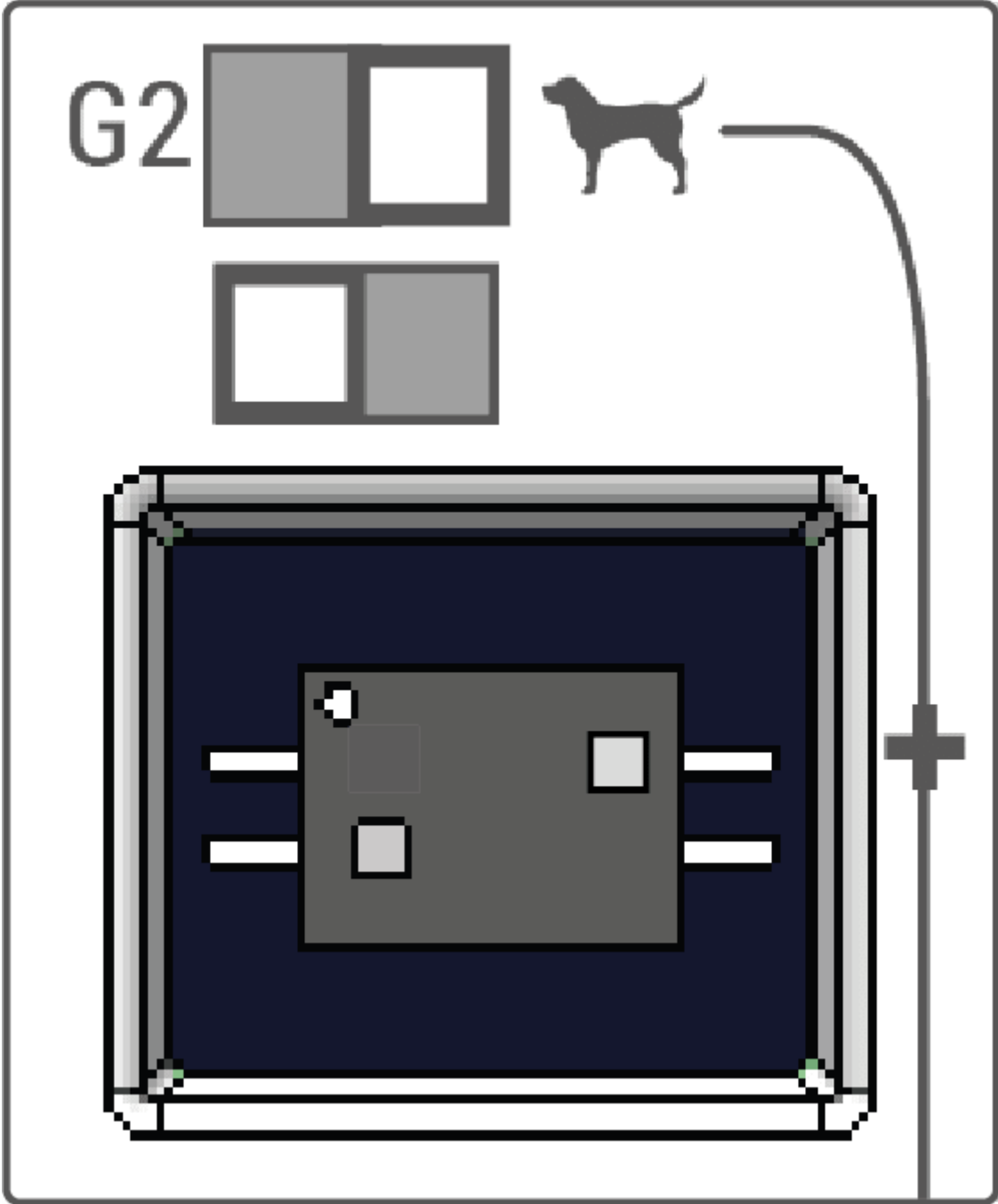

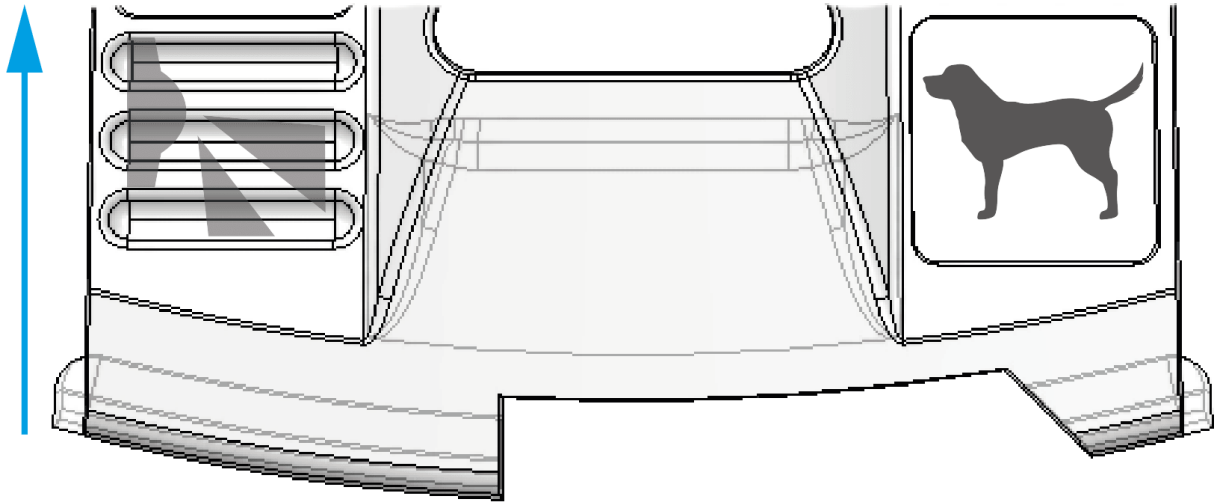

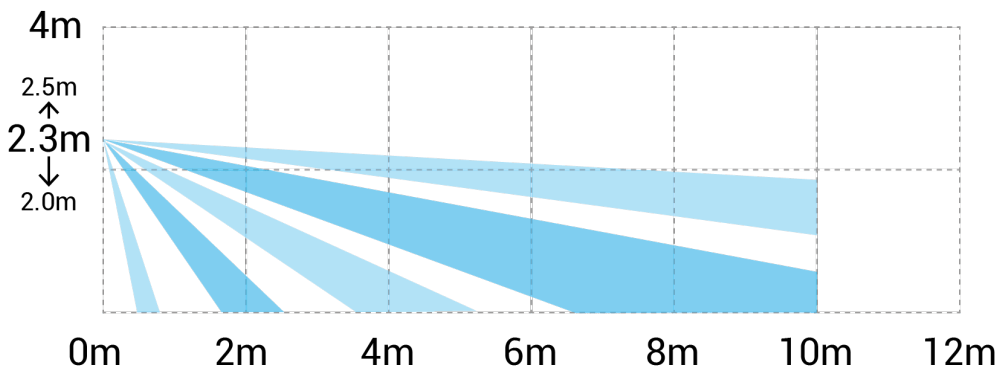
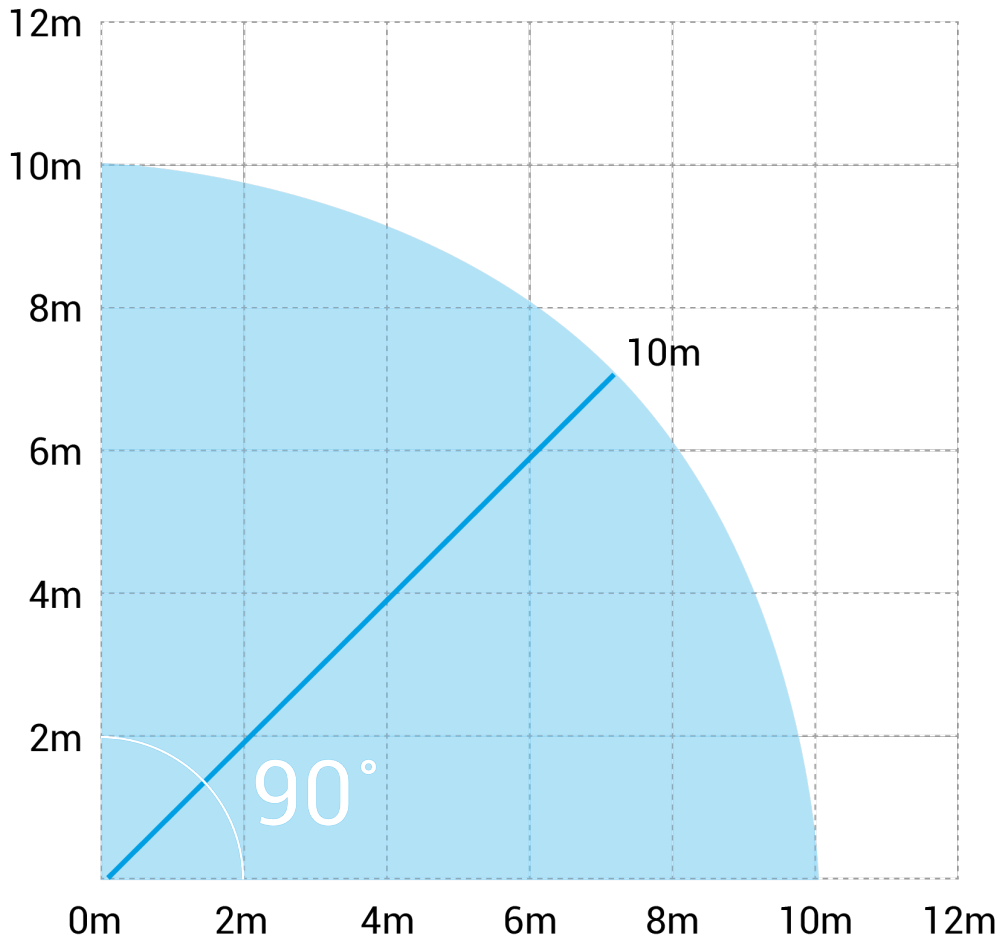

2.3 CAPTURE D20-W

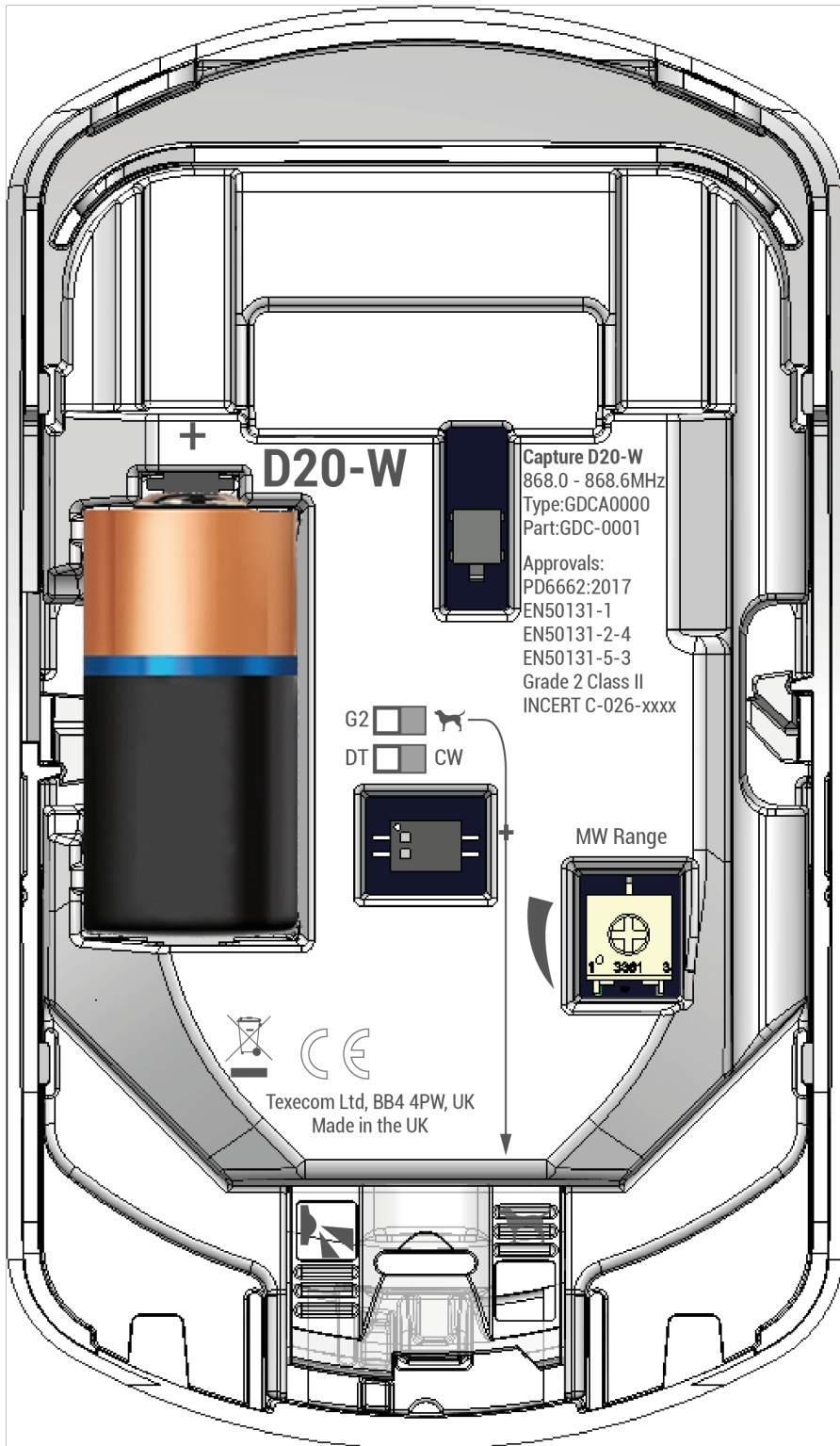

G2 coverage

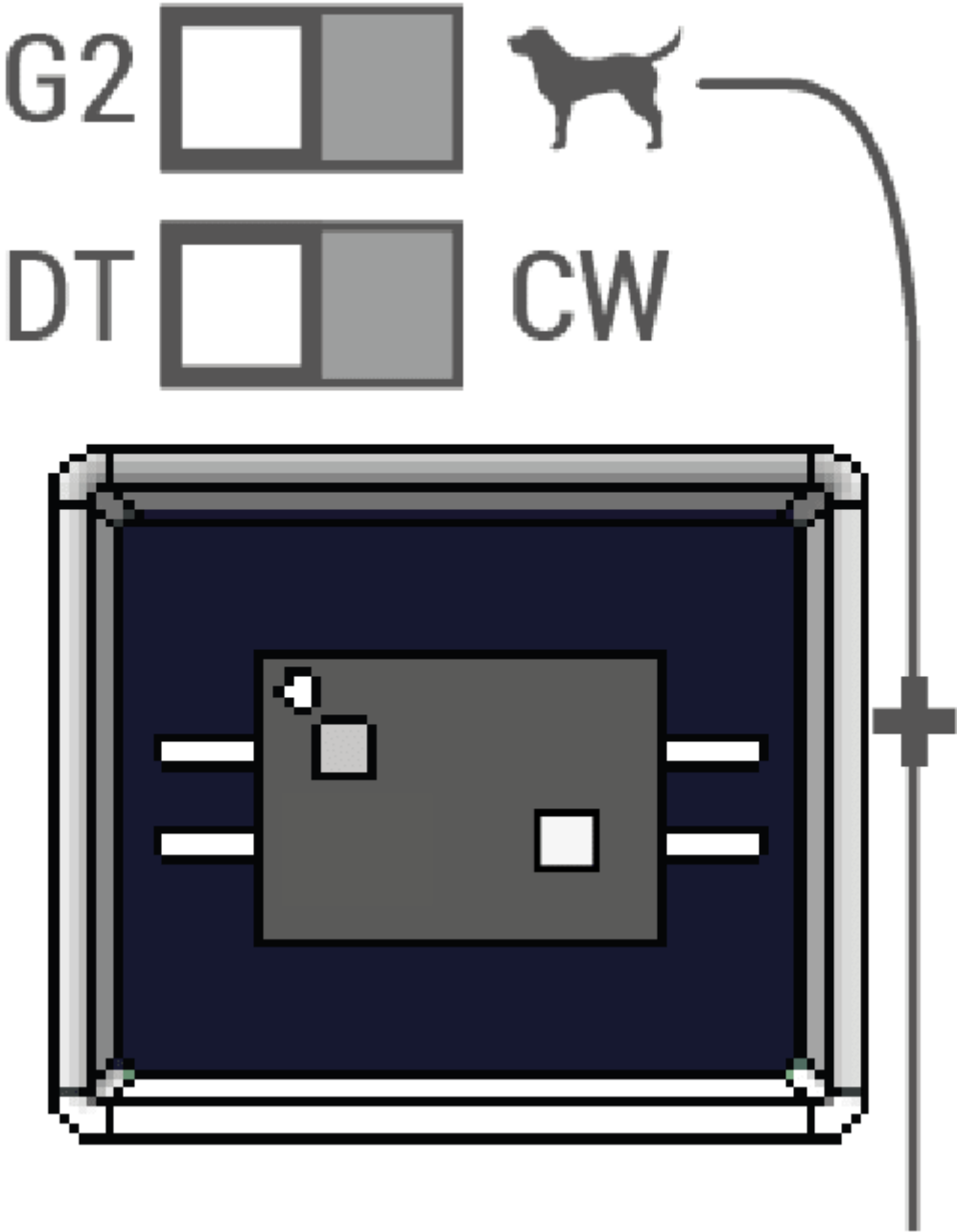

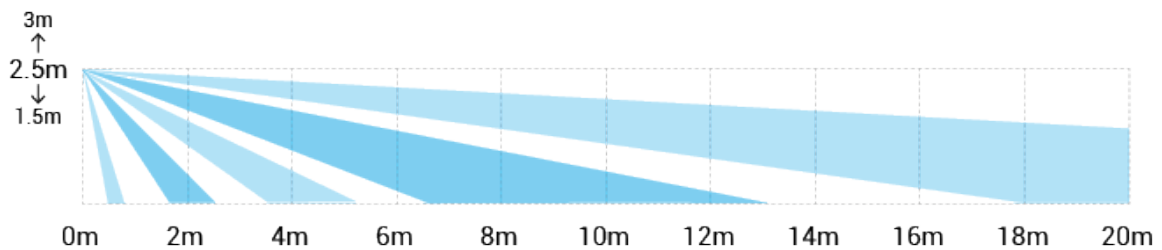
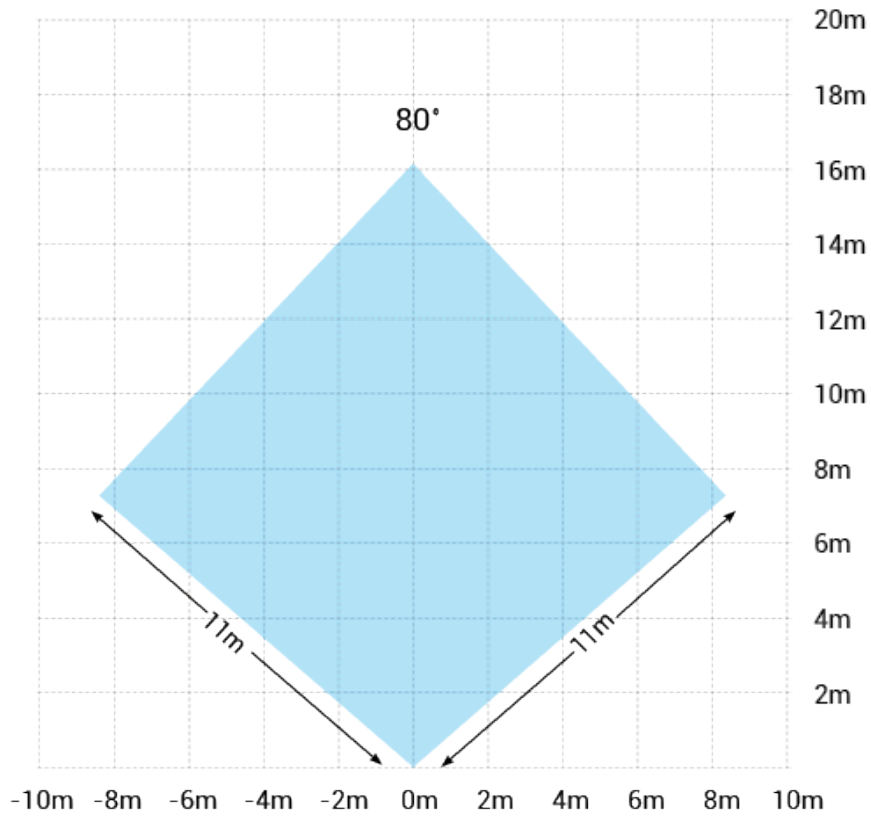

Pet coverage (The product is compliant with EN 50131-2-2 or EN 50131-2-4 and INCERT when in the G2 setting only.)

G2



DT



CW

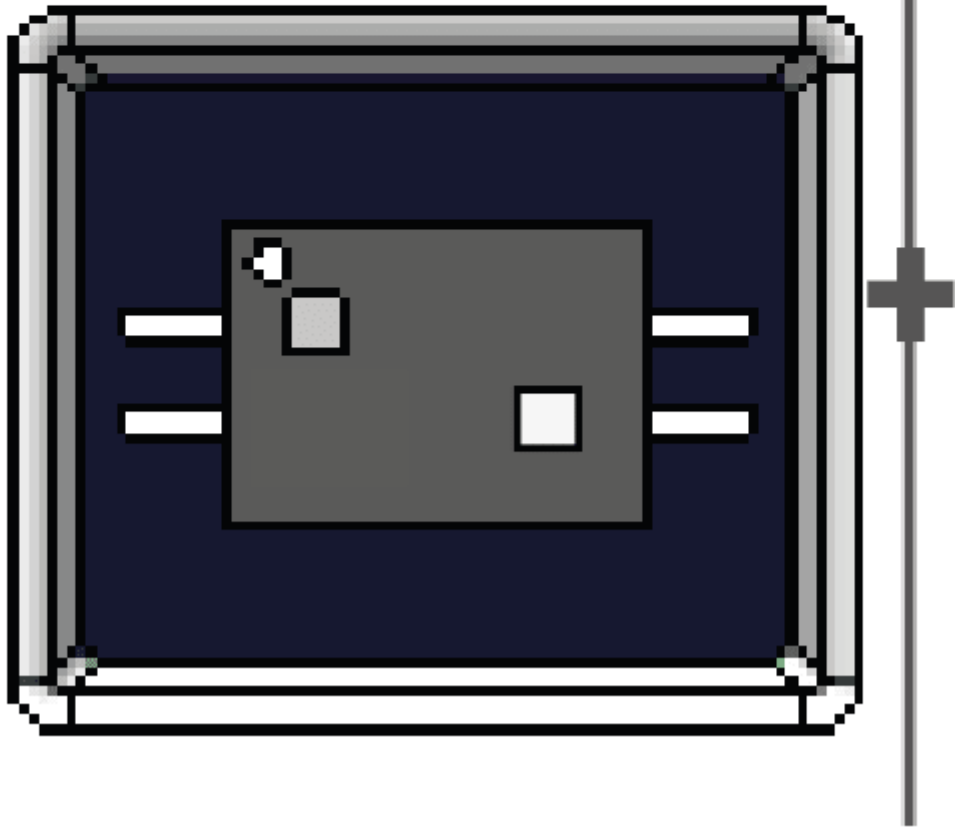

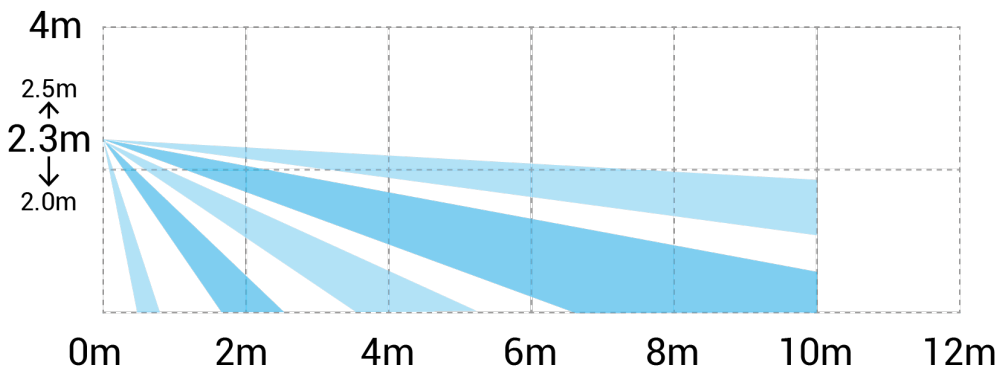
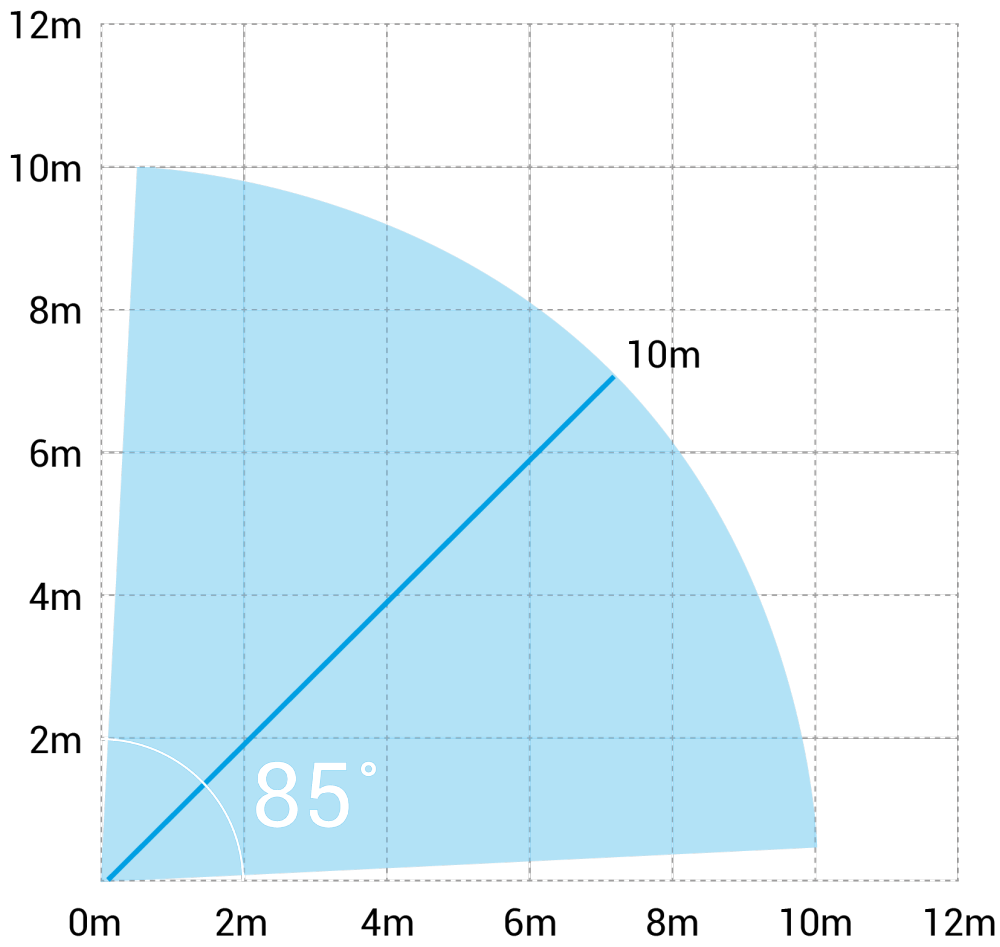

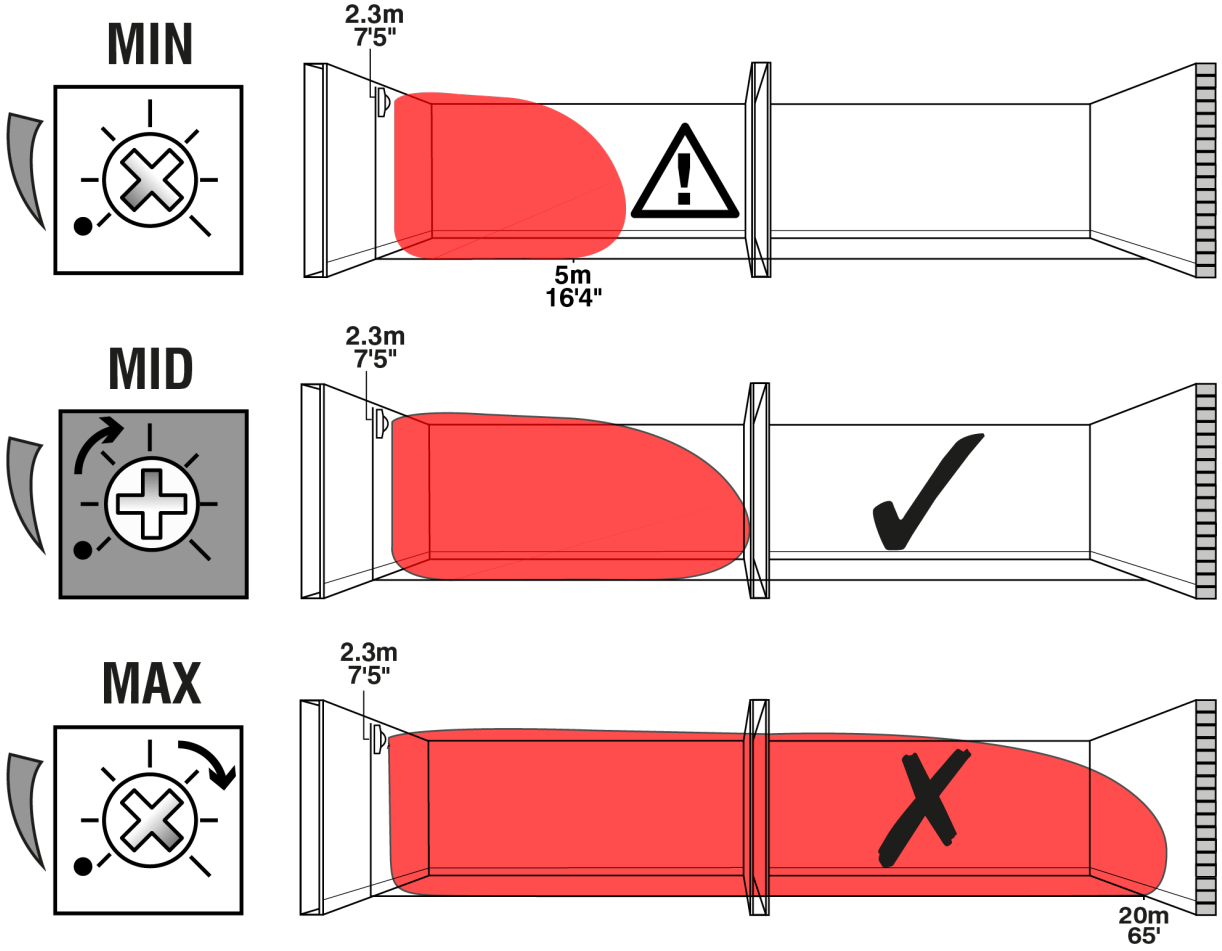

2.4 CAPTURE CQ-W

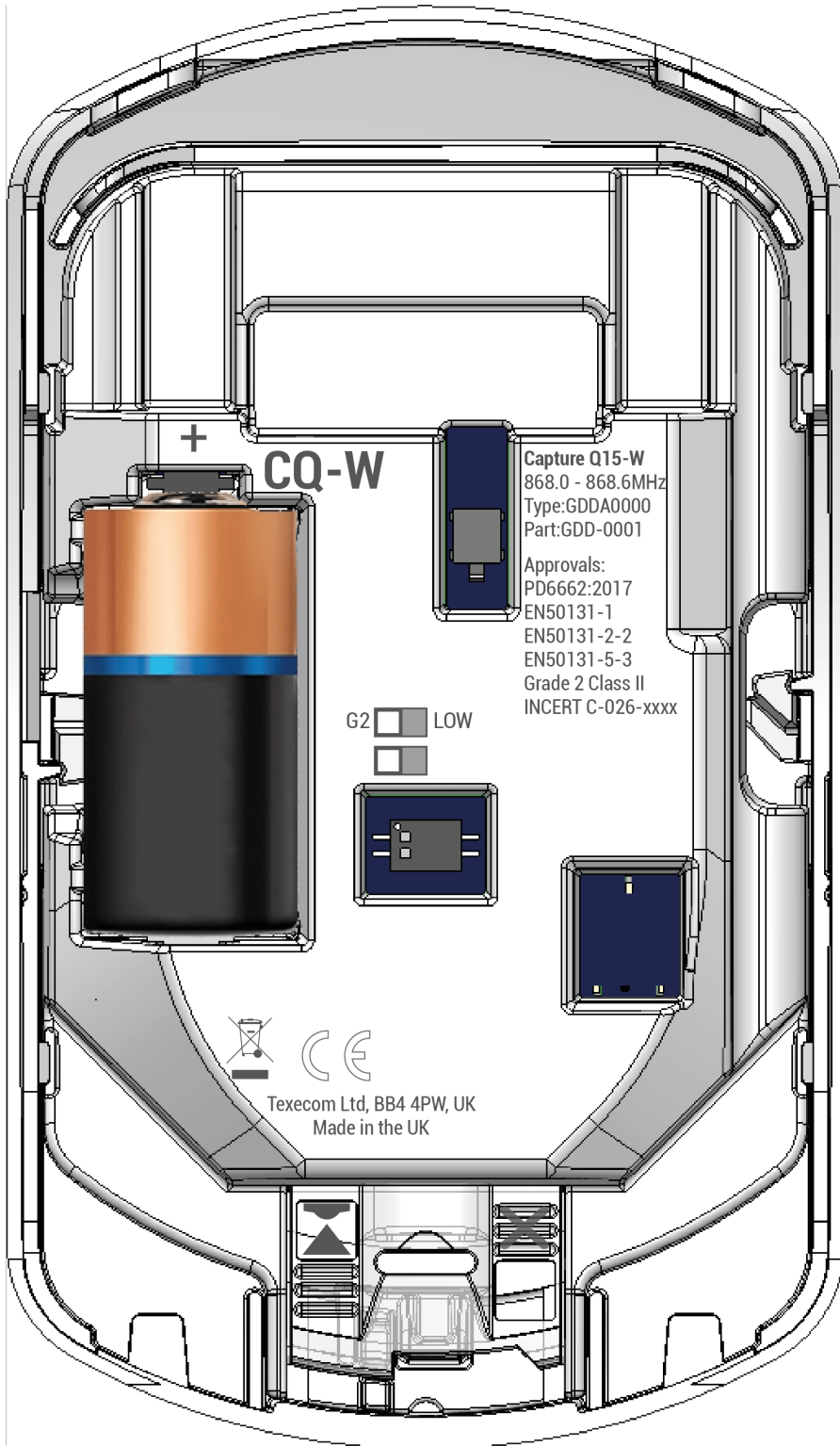

Capture Q15-W
868.0 - 868.6MHz
Type:GDDA0000
Part:GDD-0001

Approvals:
PD6662:2017
EN50131-1
EN50131-2-2
EN50131-5-3
Grade 2 Class II
INCERT C-026-xxxx

G2 LOW



Texcom Ltd, BB4 4PW, UK
Made in the UK

PIR

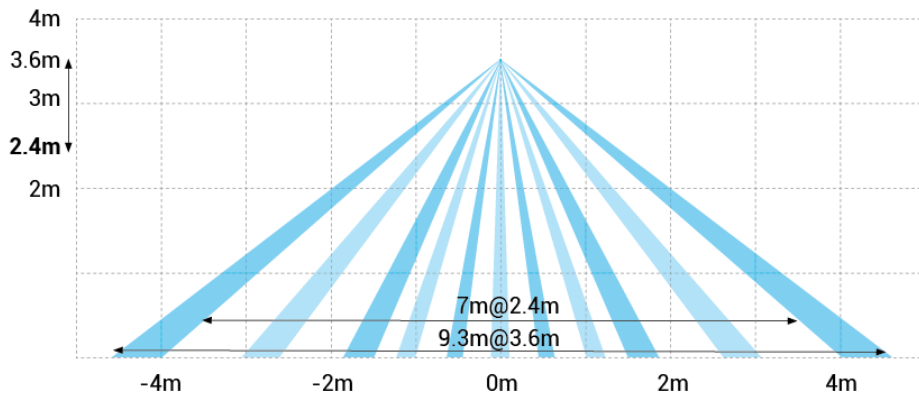
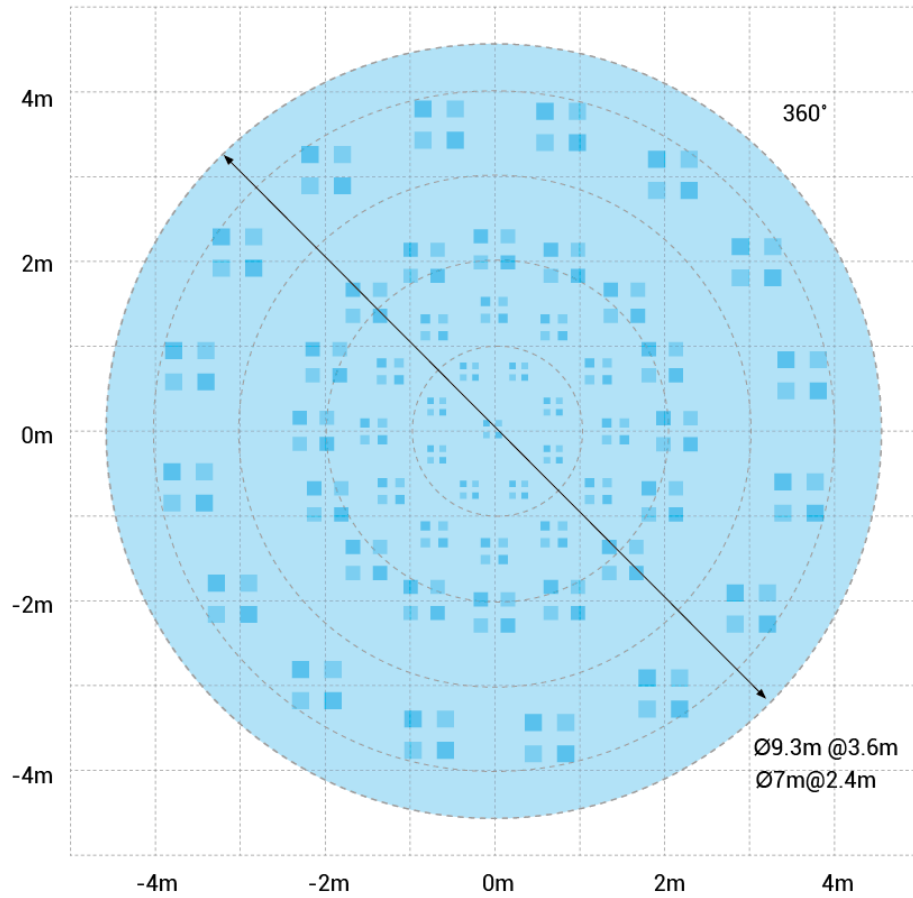

DO NOT USE

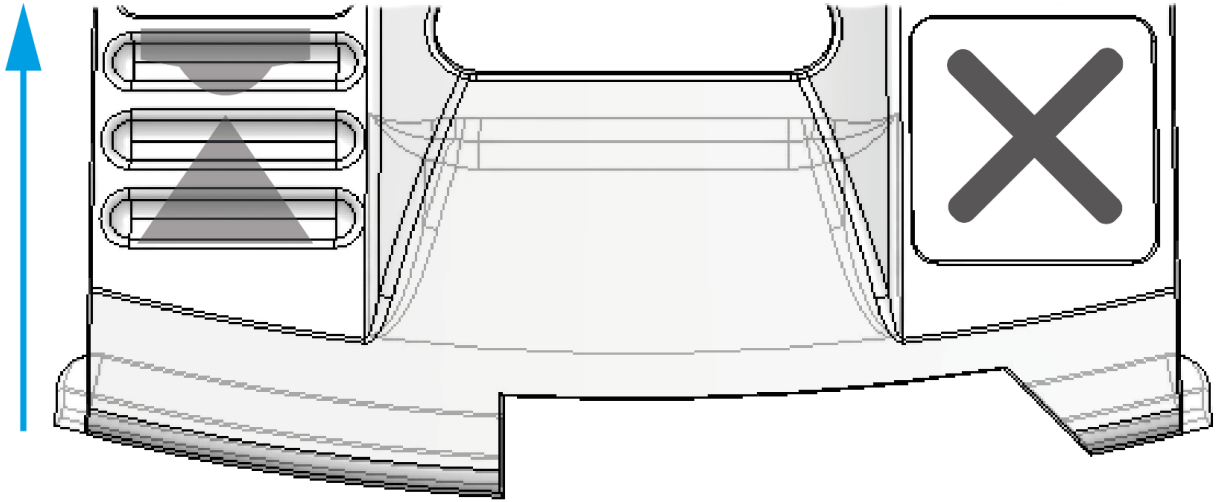

2.5 CAPTURE CD-W

CAPTURE CD-W is **NOT** Certified by KIWA (Telefication) B.V.

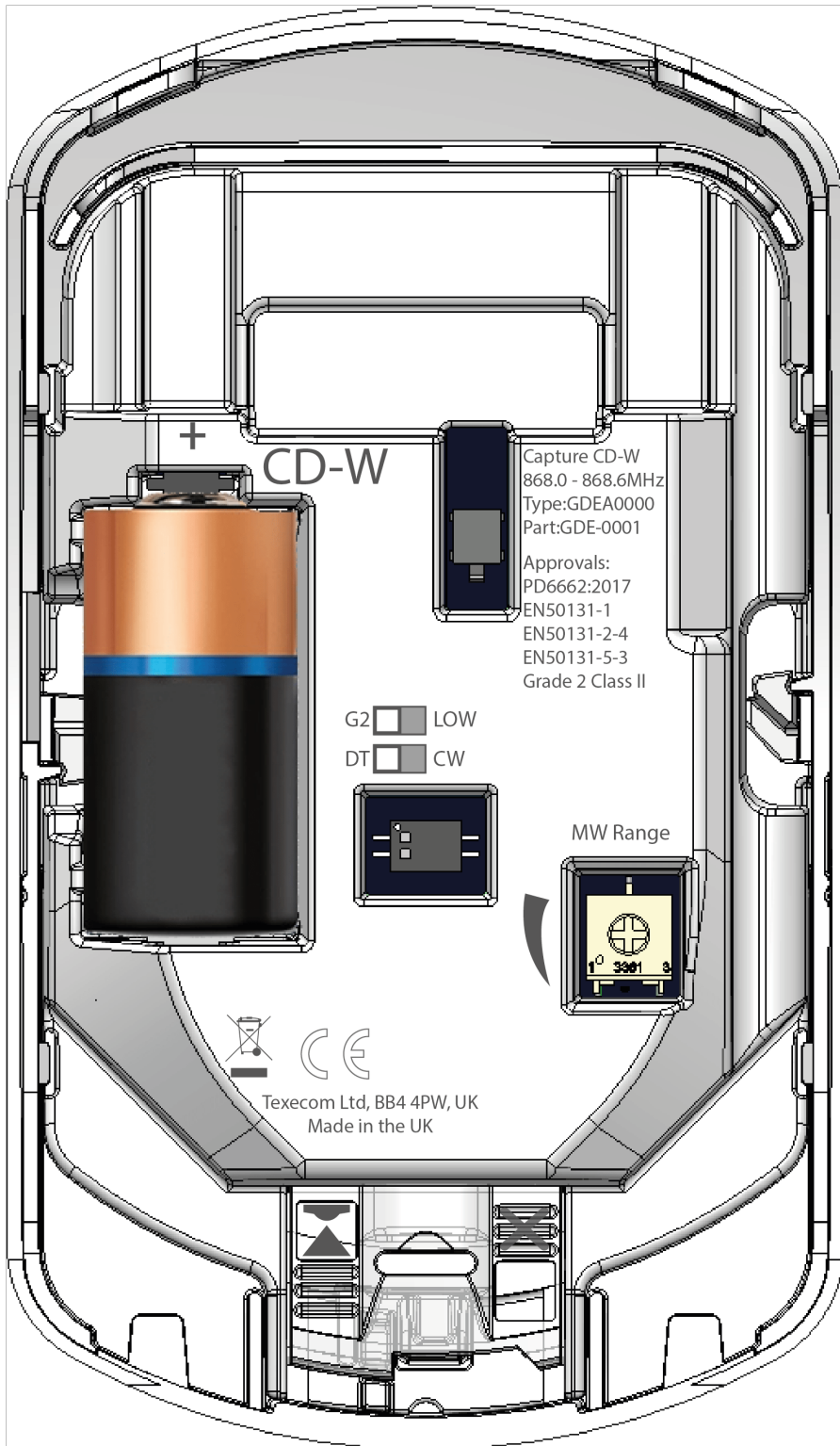

PIR

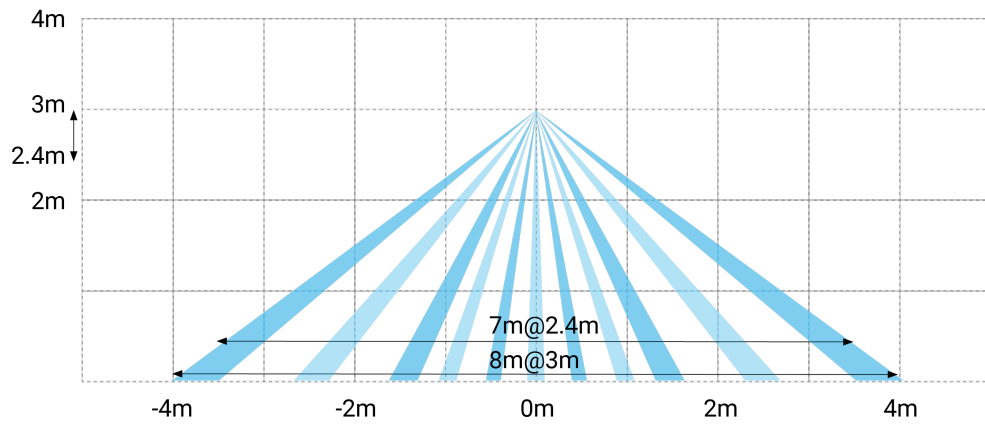
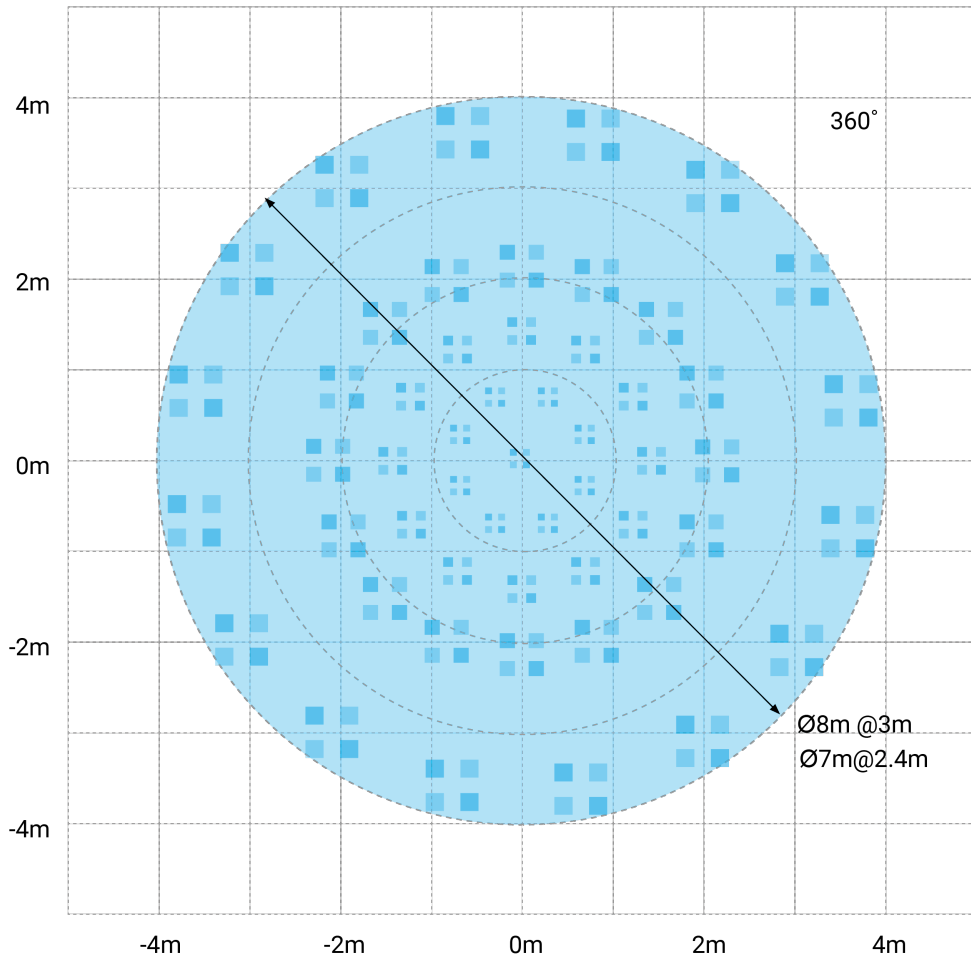

Microwave

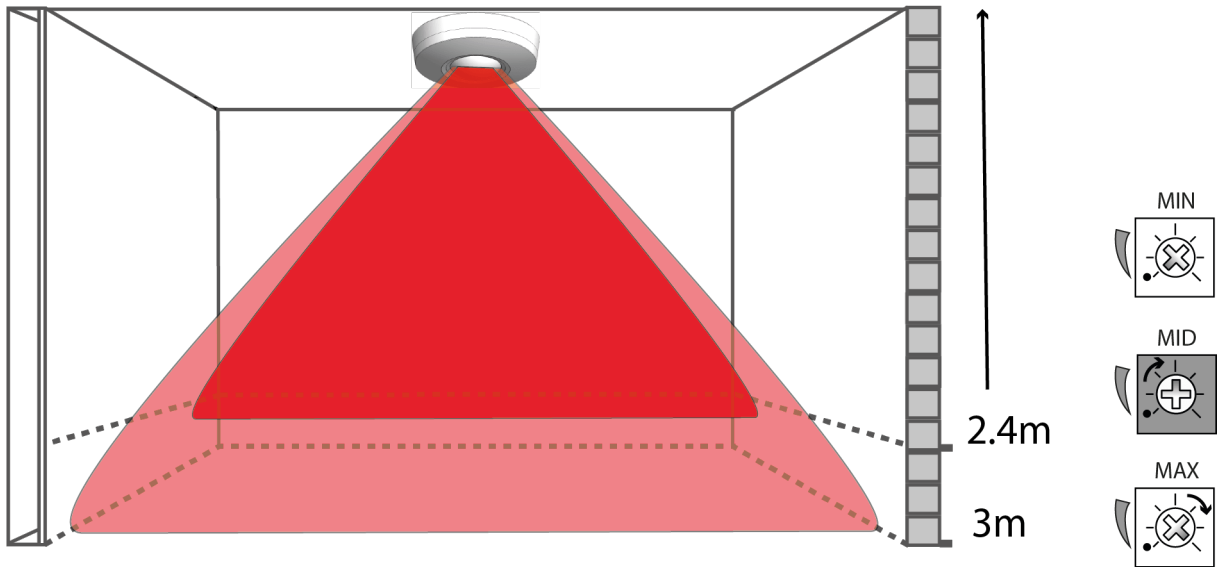

DO NOT USE

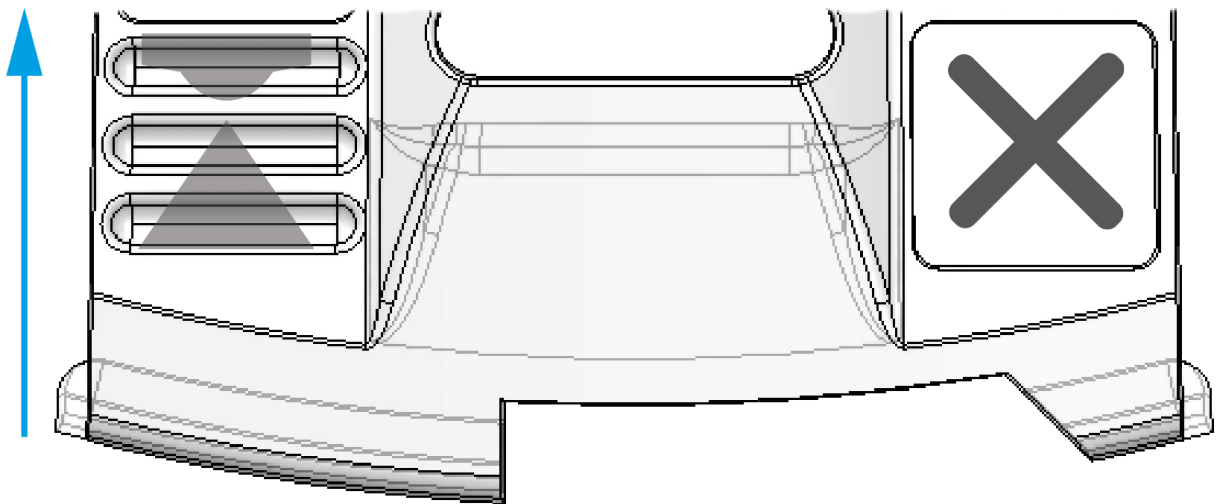

2.6 CAPTUTRE LR50-W

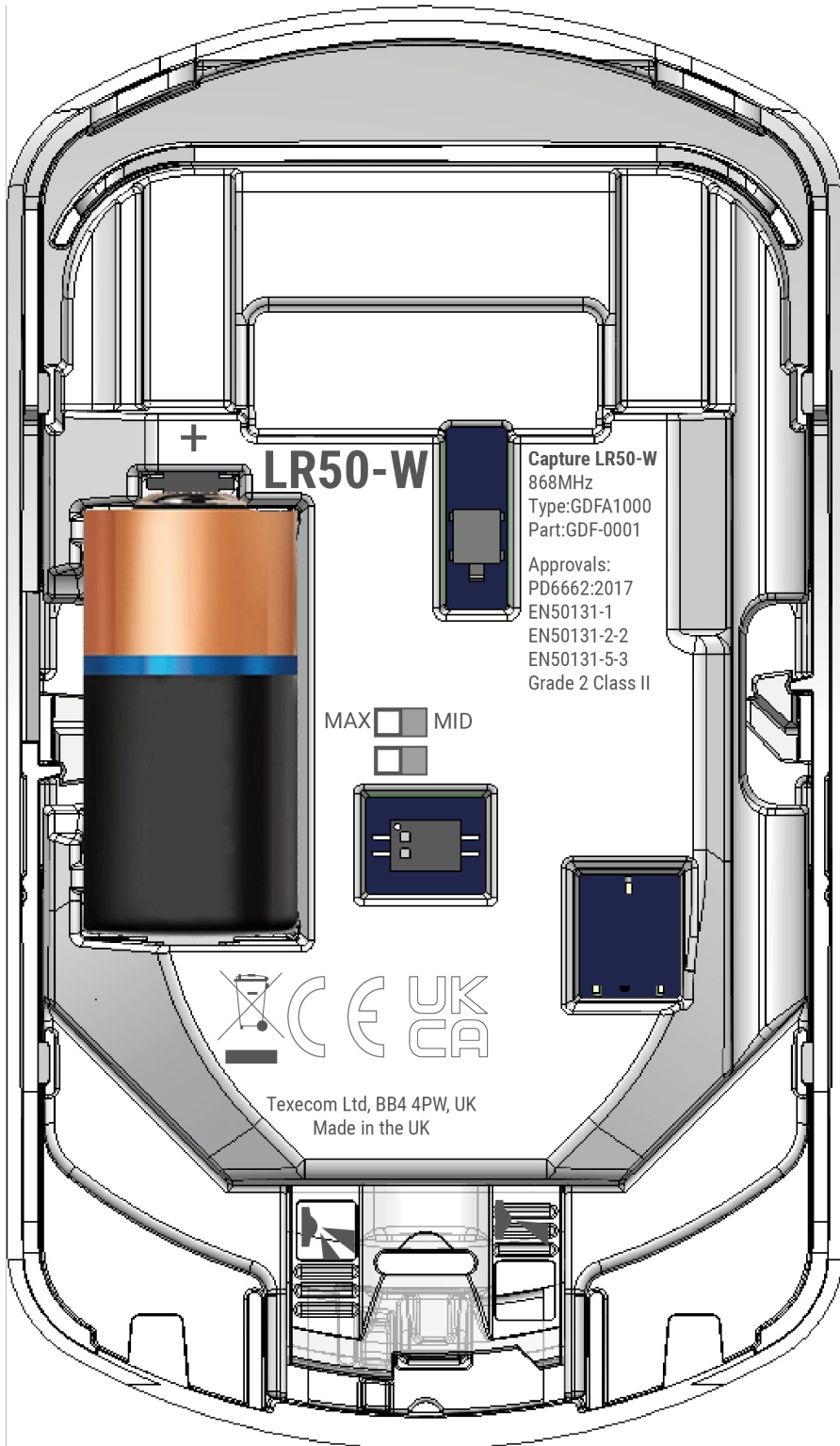

LR50-W

Capture LR50-W
868MHz
Type:GDFA1000
Part:GDF-0001

Approvals:
PD6662:2017
EN50131-1
EN50131-2-2
EN50131-5-3
Grade 2 Class II

MAX MID



Texcom Ltd, BB4 4PW, UK
Made in the UK

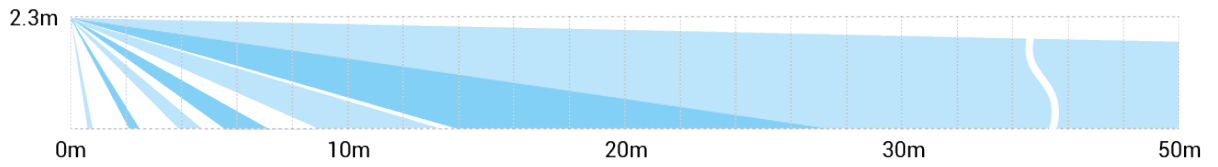
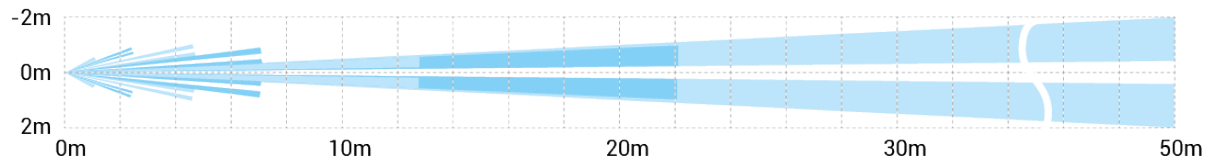

2.7 CAPTURE PET-W

The CAPTURE PET-W is not approved INCERT.

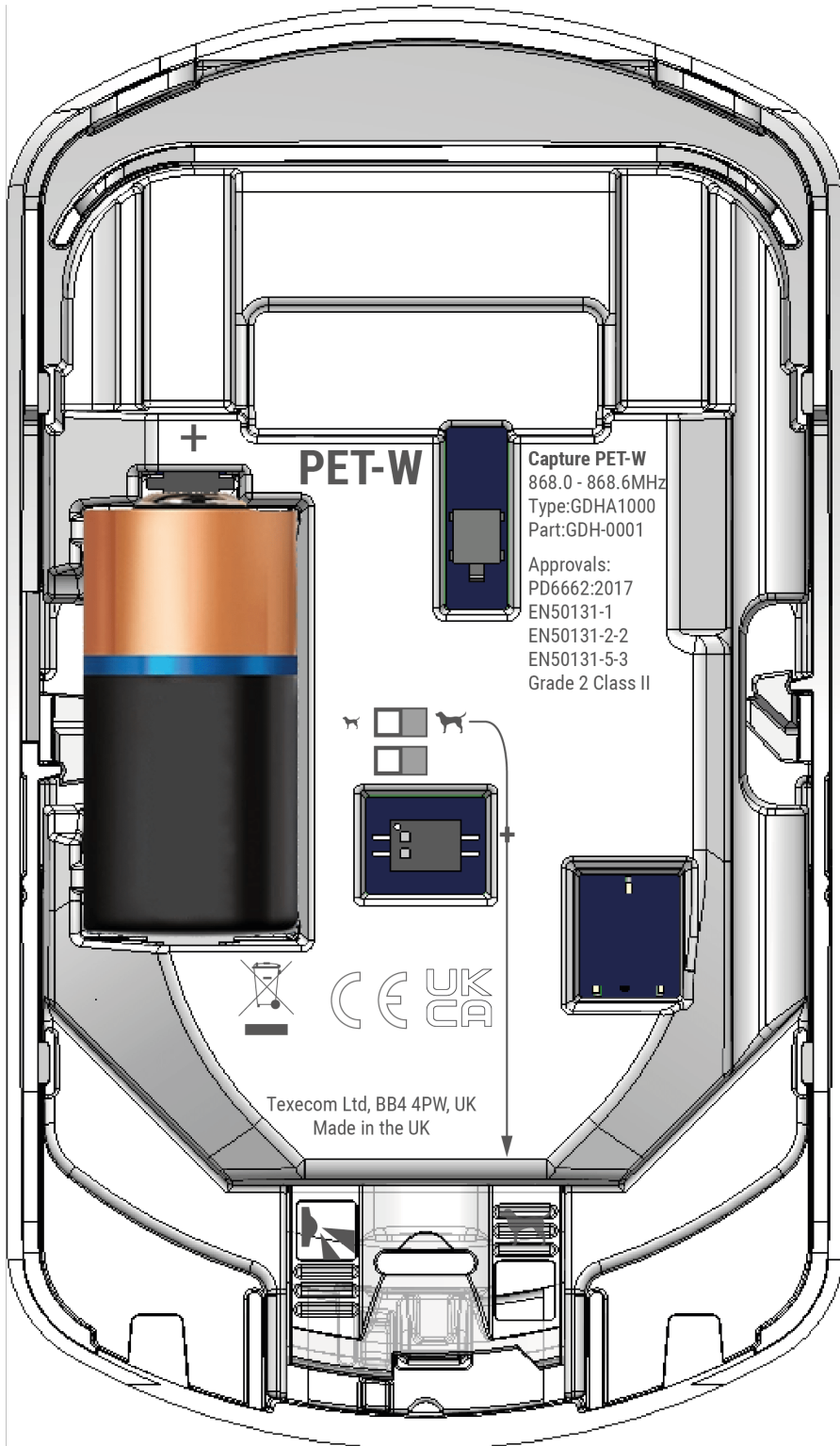

PET-W

Capture PET-W
868.0 - 868.6MHz
Type:GDHA1000
Part:GDH-0001

Approvals:
PD6662:2017
EN50131-1
EN50131-2-2
EN50131-5-3
Grade 2 Class II



Texecom Ltd, BB4 4PW, UK
Made in the UK

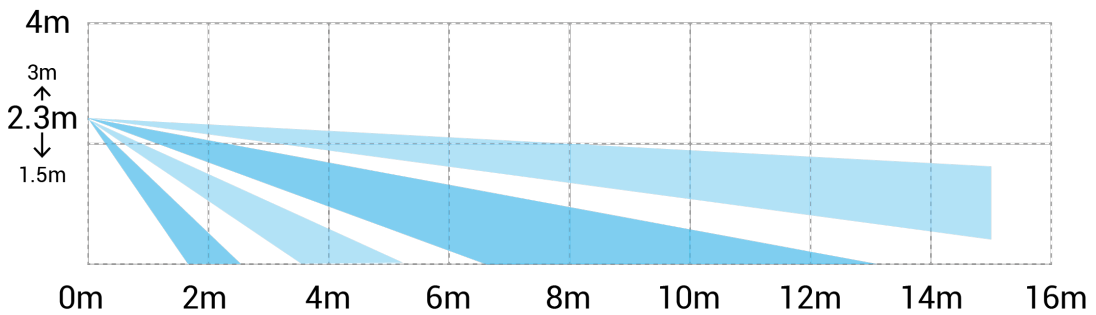
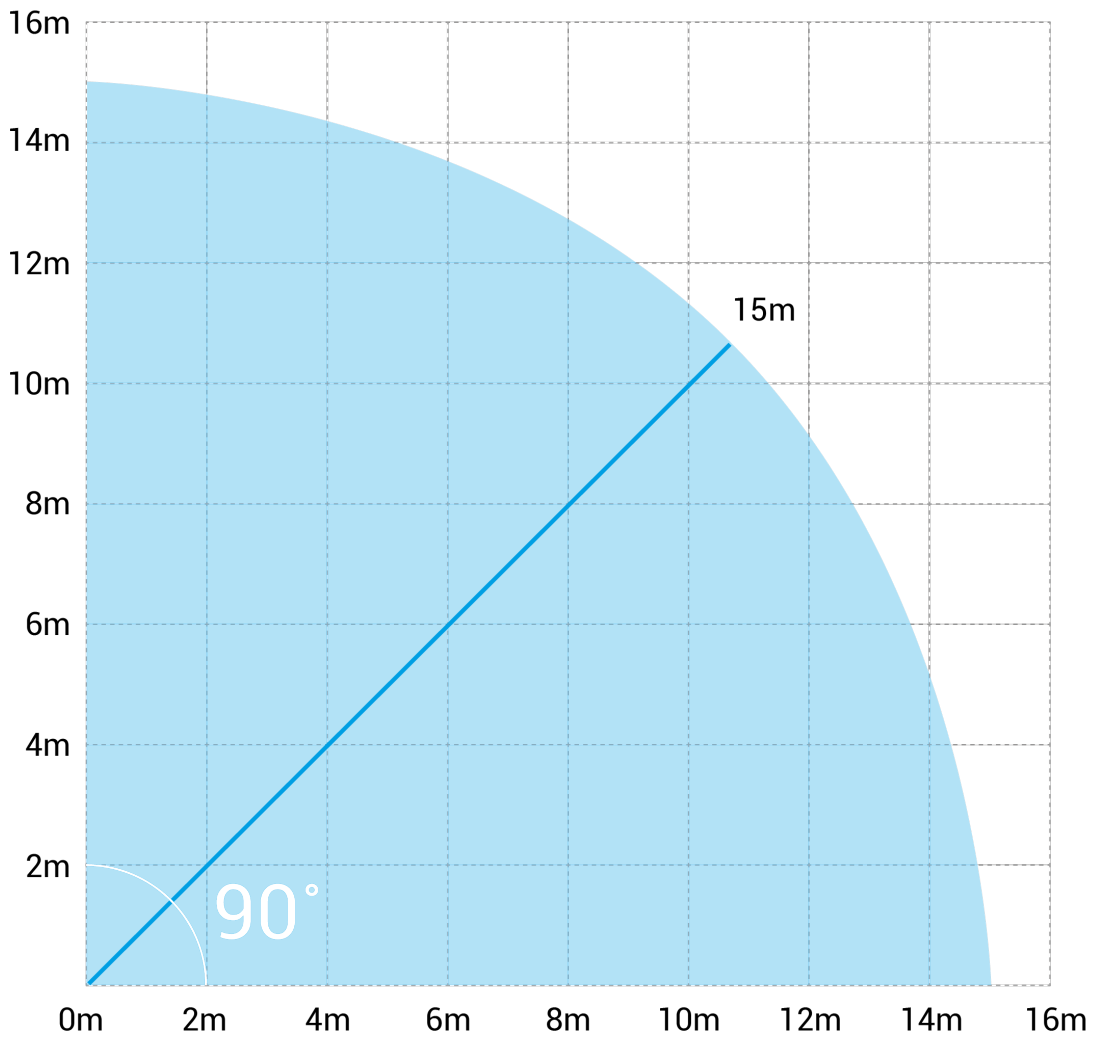

2.8 CAPTURE C15-W

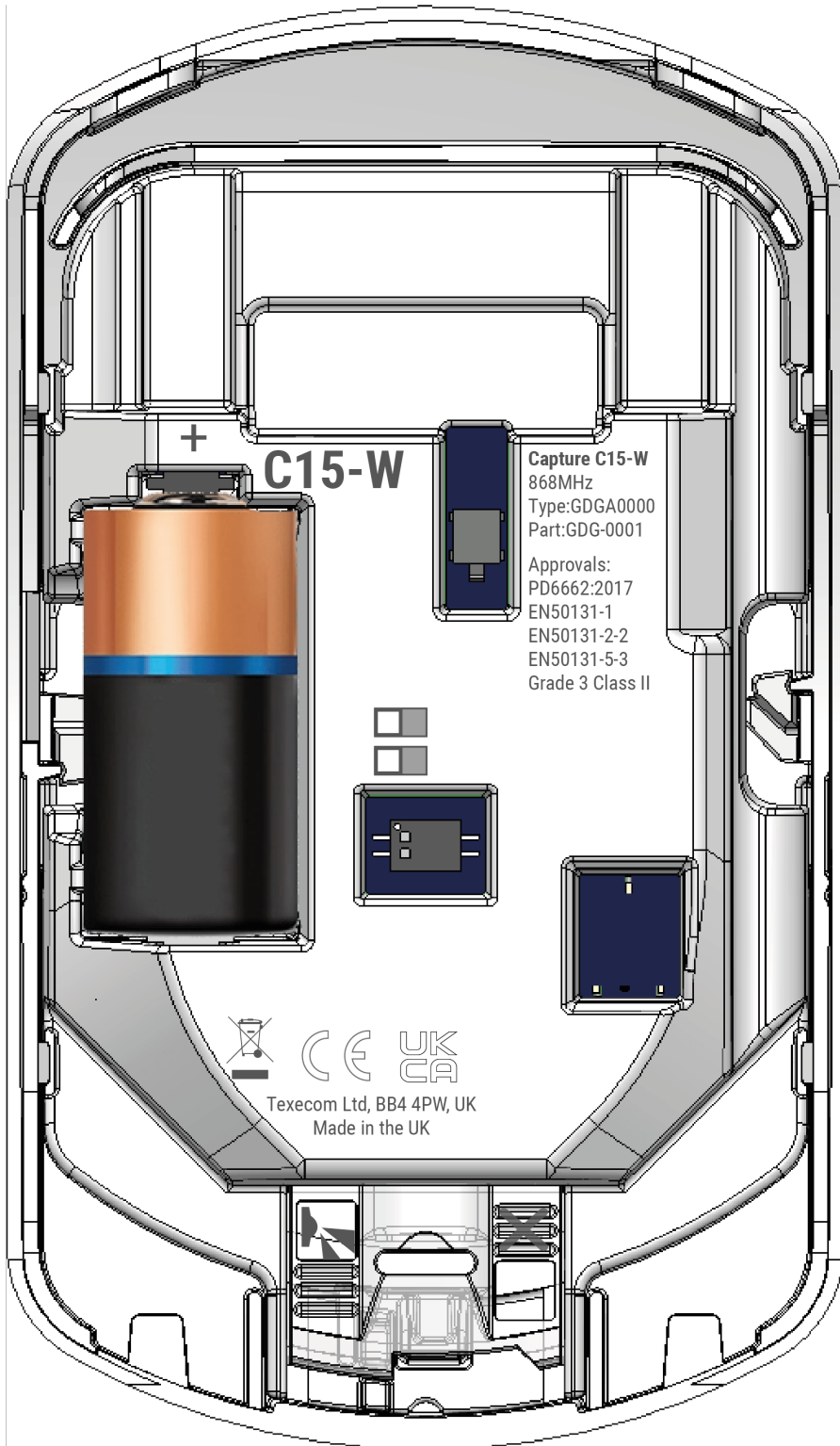

C15-W

Capture C15-W
868MHz
Type:GDGA0000
Part:GDG-0001

Approvals:
PD6662:2017
EN50131-1
EN50131-2-2
EN50131-5-3
Grade 3 Class II

  
Texecom Ltd, BB4 4PW, UK
Made in the UK

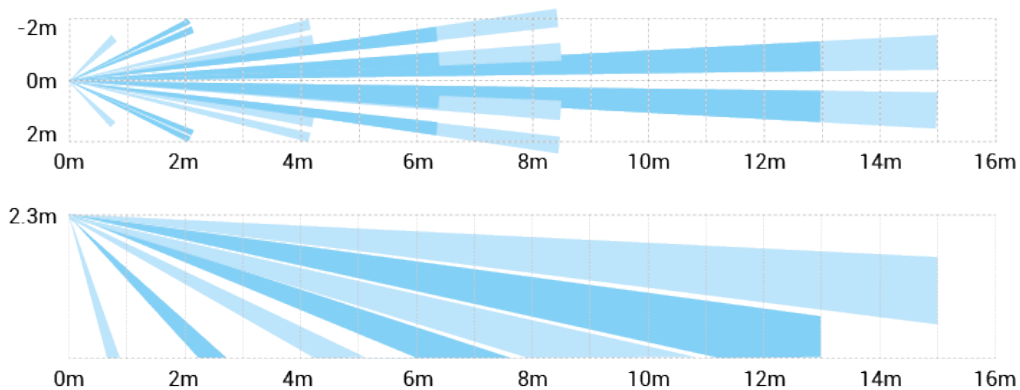

3.0 Accessories

3.1 Branding

Branding is available for wall mount devices from our website [CLICK HERE](#) and consists of a printed insert and a clear cover which fits over the front of the device and holds the insert in place.

Note: The cover should be removed before sliding the front of the device off for servicing or adjustment.







*Bespoke branding.
Captured.*



ABC ALARMS

3.2 Optional wall or ceiling brackets

Part Numbers

Pack of 10 brackets **AFU-0004** (not compliant with INCERT EN50131-2-2 and EN50131-2-4)

Screws & Fixings

To ensure maximum stability 2 screws should be used for either mounting option.

Dependent on the mounting substrate, suitable fixings may be required. The size and type will depend on the choice of fixing screw.

- Ceiling mount
 - Minimum screw size 3.5 X 16mm CSK
 - Maximum screw size 4.0 X 70mm CSK
- Wall mount
 - Minimum screw size 3.0 X 12mm Pan head
 - Maximum screw size 3.5 X 40mm Pan head

Ceiling mount installation

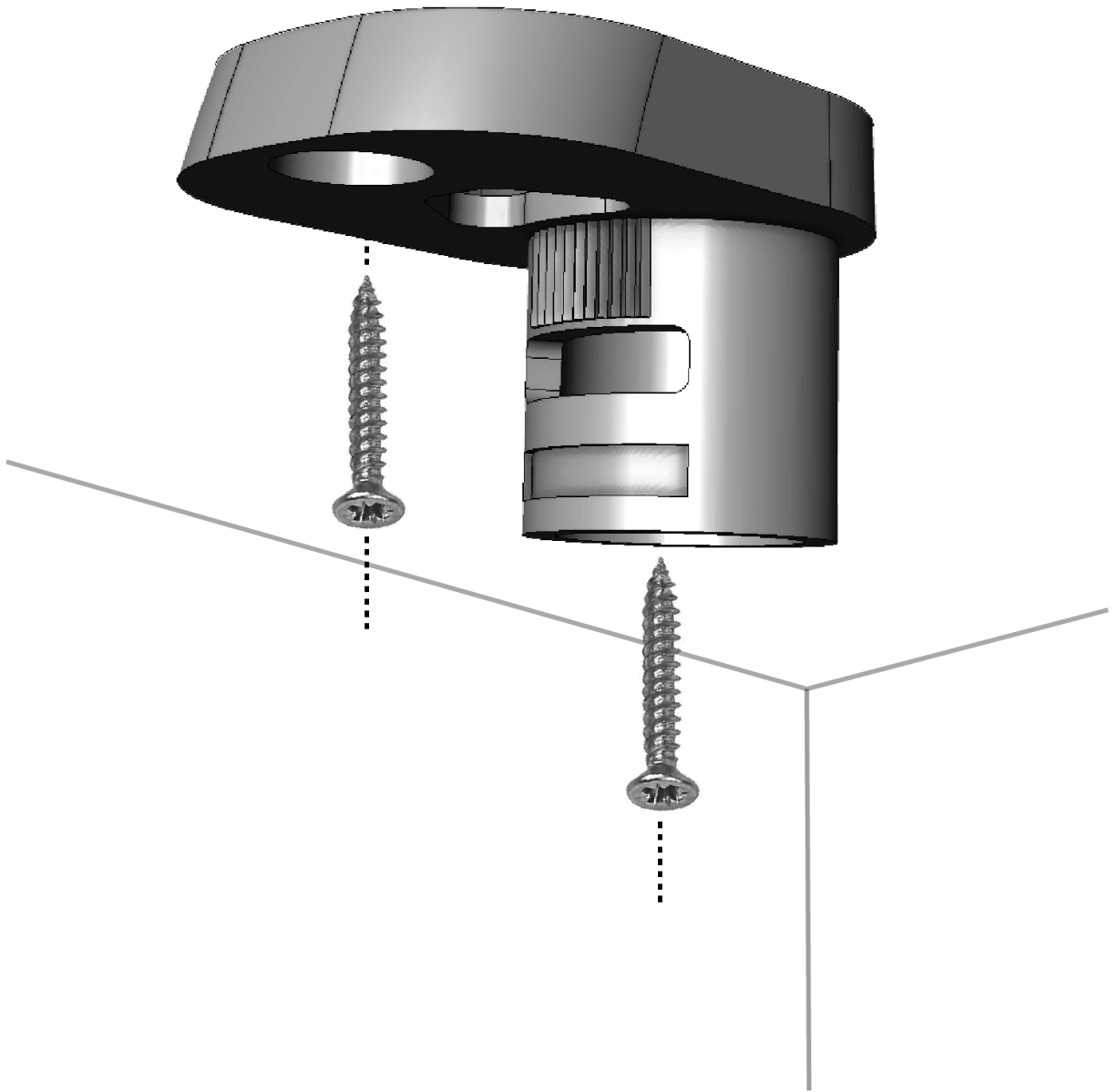

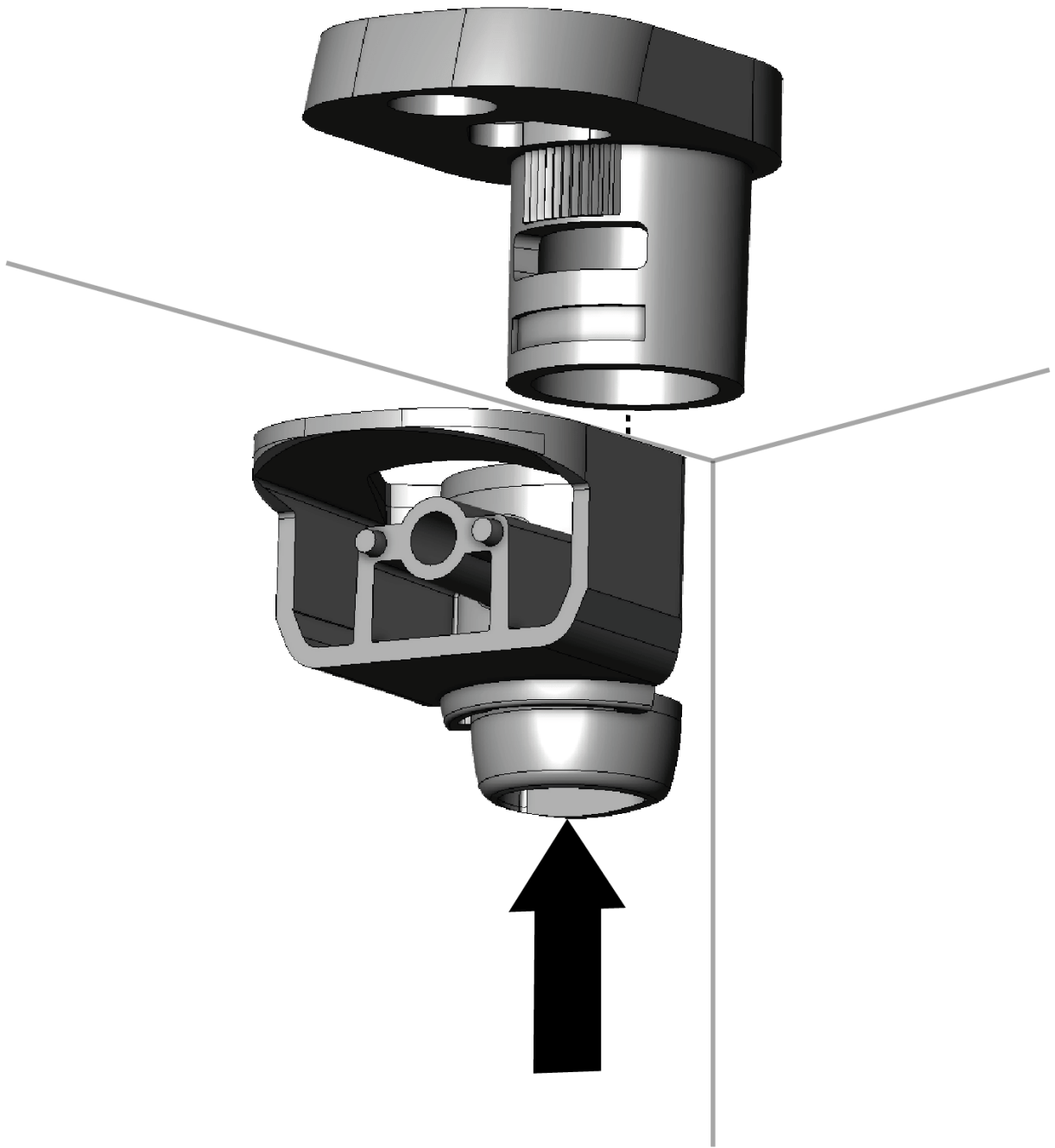

Wall mount installation

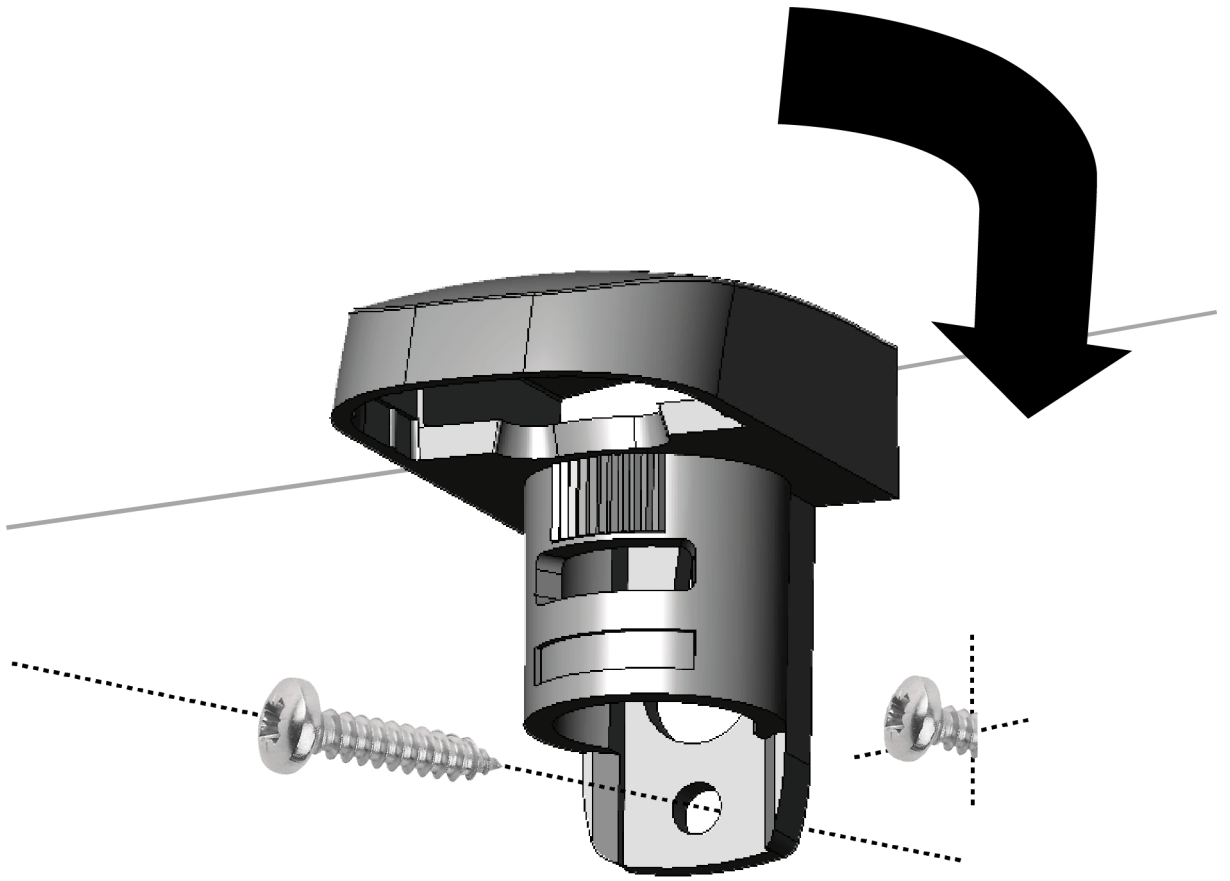

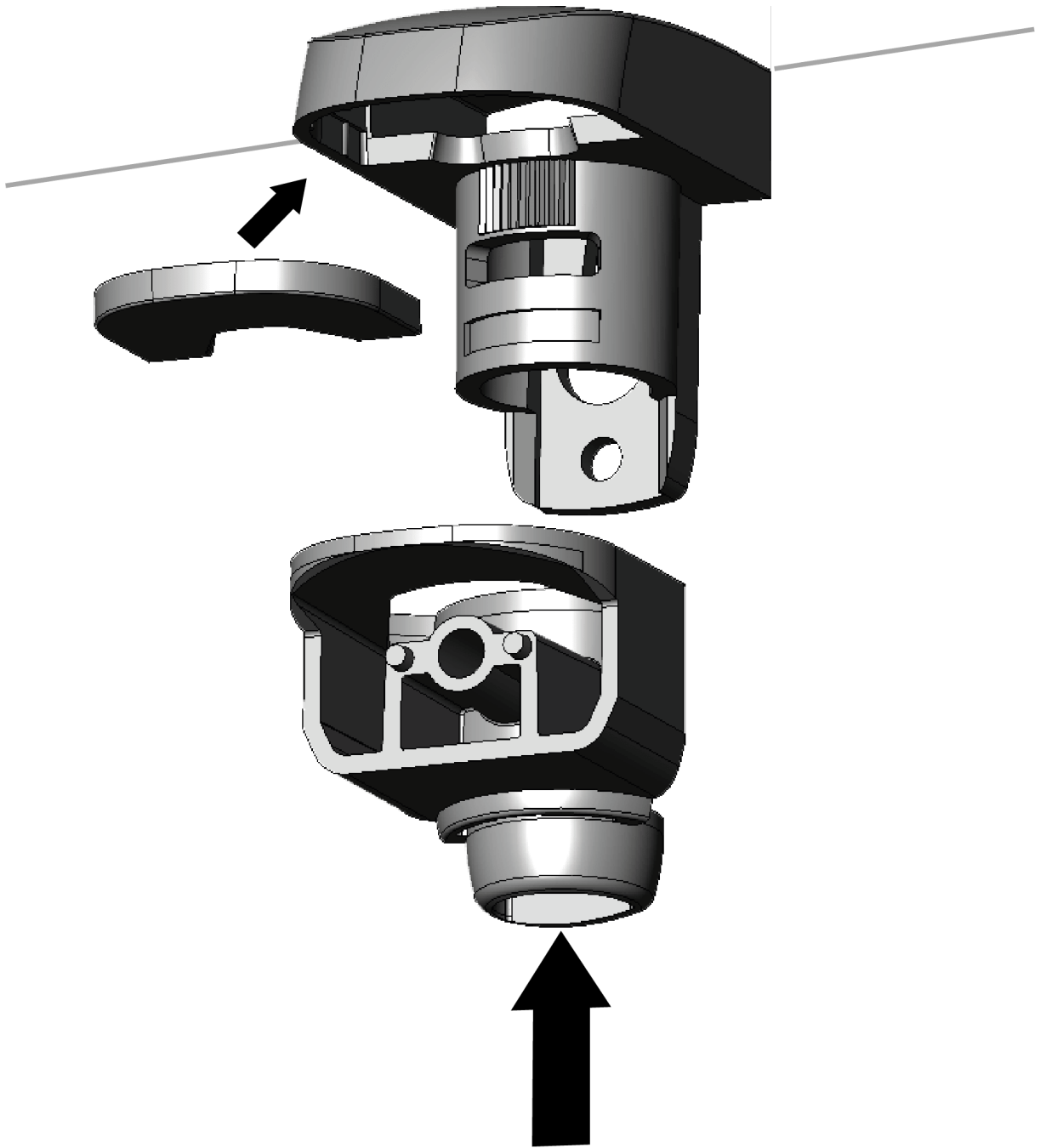



4.0 Specifications

Specifications	P15-W, Q20-W, D20-W, CQ-W, CD-W LR50-W
	EN50131-2-2 (P15-W, Q20-W, CQ-W), EN50131-2-4 (D20-W, CD-W), EN50131-1, PD6662:2017 Grade 2 Class II
Product Type & Frequency Band	P15-W, Q20-W, D20-W, CQ-W, CD-W LR50-W 868.2 - 868.4MHz (GDAA-1000, GDBA-1000, GDDA-1000, GDCA-1000, GDEA-1000, GDFA-1000 866.2 - 866.4MHz (GDAA-3000, GDBA-3000, GDDA-3000, GDCA-3000, GDEA-3000 GDFA-3000) 433.3 - 433.7MHz (GDAA-2000, GDBA-2000, GDDA-2000, GDCA-2000, GDEA-2000)
Receiver	Category 1, Class 2
Receiver LBT	Listen Before Talk

Transmitter Duty Cycle	<1%
Max RF Power	10mW
Low Voltage Signal	2.85V
Operating Voltage	3V
Maximum Current	P15-W, Q20-W, CQ-W = 18mA D20-W, CD-W = 38mA
Quiescent Current	P15-W, Q20-W, CQ-W = 21uA D20-W, CD-W = 22uA
Relative Humidity	0-95% non-condensing
Operating Temperature	-10°C to 55°
Weight	P15-W, Q20-W, CQ-W (no ring, fascia or battery) - 93g P15-W, Q20-W (with fascia, insert and battery) - 127g CQ-W (with ring and battery) - 167g D20-W, CD-W (no ring, fascia or battery) - 98g D20-W (with fascia, insert and battery) -133g CQ-W (with ring and battery) - 172g
Dimensions	Wall Mount: Width 65mm, Height 112mm, Depth 43mm. Ceiling Mount: 125mm Diameter, Depth 43mm.

PSU Characteristics (Type C)	P15-W/Q20-W/CQ-W	D20-W/CD-W
Quiescent Current (Set and Unset)	21uA	22uA
Current During Alarm (Period)	18mA (40ms)	38mA (40ms)
Current During Set and Unset (Period)	18mA (40ms)	18mA (40ms)

Current During Supervision (Period)	18mA (40ms)	18mA (40ms)
Supervision Frequency (Per Hour)	4	4

PSU Characteristics (Type C)	
Capacity of Supplied Battery	1250mAH
Low Voltage Signal	2.85V
End of Life Voltage	2.20V

After the low battery value has been signalled the product will operate for a minimum of 30 days with an average daily current draw of 21uA (22uA for the D20-W and CD-W). The battery will have a remaining capacity of at least 27mAh after low battery is signalled.

When replacing the battery in the product, care should be taken to only use a battery with a similar or greater capacity.

Note: A low battery signal can only be cleared by replacing the device's battery.

5.0 Legal information

5.1 Supplier

Texecom Ltd, Haslingden, Lancashire, BB4 4PW, UK.

Made in England

5.2 WEEE Directive

2012/19/EU (WEEE Directive): Products marked with this symbol cannot be disposed of as unsorted municipal waste in the European Union. To recycle, return this product to your local supplier upon the purchase of equivalent new equipment, or dispose of it at designated collection points. For more information see: www.recyclethis.info.

5.3 Maintenance

Test yearly by the installer

5.4 Warranty

Lifetime warranty. (excludes battery which is 24 months) As the CAPTURE P15-W, Q20-W, D20-W, CQ-W, CD-W is not a complete alarm system, but only a part thereof, Texecom cannot accept responsibility or liability for any damages whatsoever based on a claim that the CAPTURE P15-W, Q20-W, D20-W, CQ-W, CD-W failed to function correctly. Due to our policy of continuous improvement, Texecom reserves the right to change specification without prior notice. Texecom provides a **10-year warranty** to end user customers who purchase new products in its Capture range (**Products**). Further details of this 10-year warranty are set out [here](#). A current list of products can be found here: <https://www.capture.texe.com/select>

Hereby, Texecom declares that the equipment type :

868.2 – 868.4MHz (GDAA-1000, GDBA-1000, GDCA-1000, GDDA-1000, GDEA-1000)

866.2 – 866.4MHz (GDAA-3000, GDBA-3000, GDCA-3000, GDDA-3000, GDEA-3000)

433.3 – 433.7MHz (GDAA-2000, GDBA-2000, GDCA-2000, GDDA-2000, GDEA-2000)

are in compliance with the Electro-magnetic Compatibility(EMC) Directive 2014/30/EU. The full EU declaration of conformity is available here: <https://www.texe.com/help-and-support/product-certificates/>

CAPTURE P15-W, Q20-W, D20-W, CQ-W, are Certified by KIWA B.V.

CAPTURE CD-W is **NOT** Certified by KIWA B.V.

5.5 Battery safety

- Do not throw into a fire
- Do not charge
- Always observe local regulations when disposing of a battery
- Detector will transmit low battery warning when battery needs replacing
- Do not heat
- Do not short circuit
- Do not disassemble
- Replace with battery type CR123

