



# SLIMLINE PANEL HEATERS WITH LED DISPLAY & WI-FI CONTROL

Installation And Operation Instructions



**Model Number**

OSPH1000E-WIFI / 1500E-WIFI / 2000E-WIFI

Thank you for purchasing this Osily Convector Heater. Please read these instructions before installation or operation and leave with the appropriate person for future retention.

**OSPH1000E-WIFI / 1500E-WIFI / 2000E-WIFI Slimline Panel Heater  
Installation & Operating Instructions**



**DO NOT COVER**

**IMPORTANT SAFETY INFORMATION**

**WARNING:** In order to avoid overheating, do not cover the heater. We recommend that this appliance is installed by a qualified electrician in accordance to the current wiring and building regulations.

- /// This appliance is intended for internal use only in domestic and small commercial applications and warnings must be adhered to.
- /// Do not cover the heater. Never cover or obstruct in any way the heat outlet slots at the top of the heater or the air inlet slots in the base of the heater.
- /// This appliance can be used by children aged from 8 years and above and persons with reduced physical, sensory, or mental capabilities or lack of experience and knowledge if they have been given supervision or instruction concerning use of the appliance in a safe way and understand the hazards involved.
- /// Children shall not play with the appliance. Cleaning and user maintenance shall not be made by children without supervision.
- /// Some parts of this appliance can become very hot and cause burns, please ensure that the heater has been switched off and allowed to cool before cleaning etc.
- /// If the supply cord is damaged, it must be replaced by the manufacturer, its service agent or similarly qualified persons in order to avoid a hazard
- /// Please do not use the product for any other purpose. Do not use this product with an extension lead or multi plug adapter.
- /// For your safety, this heater is fitted with a thermal cut-out. If the product overheats for some reason, the cut-out prevents excessive temperatures on the product by cutting the power to the heater.
- /// There are no user serviceable parts in this appliance.
- /// Please unplug and ensure that the unit is disconnected from the mains supply before any attempt to open the case or any part of this heater

## Setting the Heater

- This heater is intended for internal installation and operation and must not be used for any other purpose.
- Do not locate the heater directly below a fixed socket outlet or connection box.
- Please ensure that the minimum clearance area is adhered to as per Fig. 1.
- Do not locate the heater in close proximity to curtains or other fabrics or materials. In humid areas such as bathrooms and kitchens, the connection box must be installed at least 250mm above the floor.
- Do not install the heater in a draught likely to affect the control setting.
- Do not locate the heater in any area that may store or contain paint, fuel or other flammable liquids.

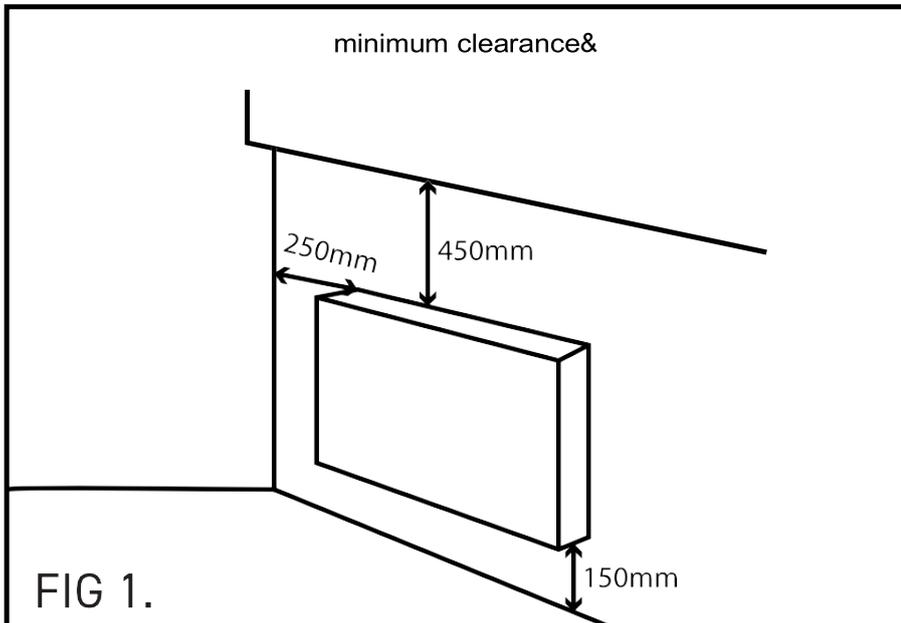
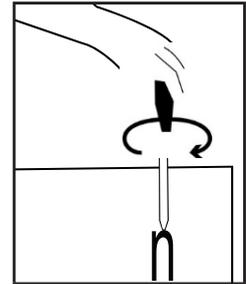

FIG 1.

## How to Install the Panel Heater

Please use the mounting brackets supplied. The heater should be positioned observing the minimum clearances stated around the heater - see Fig. 1

**Step 1.** First remove the wall bracket from the rear housing. Unscrew the screws located on the top of the 2 vertical bars of the wall bracket.



**Step 2.** Then pull out the top bar by pressing firmly both upper parts slotted into the rear housing. Slide down the wall bracket in order to remove it from the rear housing.

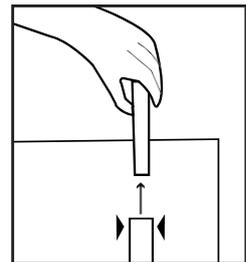

**Step 3.** Fix the wall bracket securely to the wall through the 4 screw holes provided.

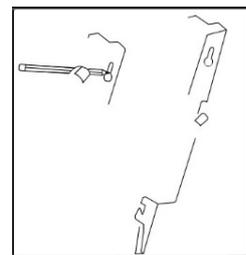

**Step 4.** Raise the heater to upright position. Present the heater and engage 2 slots of the bottom parts of the wall brackets in the wall heater's rear enclosure then pull up the heater. Then engage 2 slots of the upper parts of the wall bracket and tighten the 2 screws in order to lock the device.

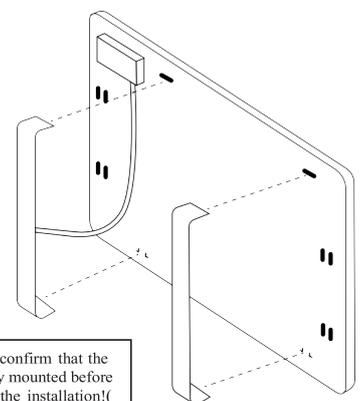

Please check to confirm that the heater is securely mounted before continuing with the installation!

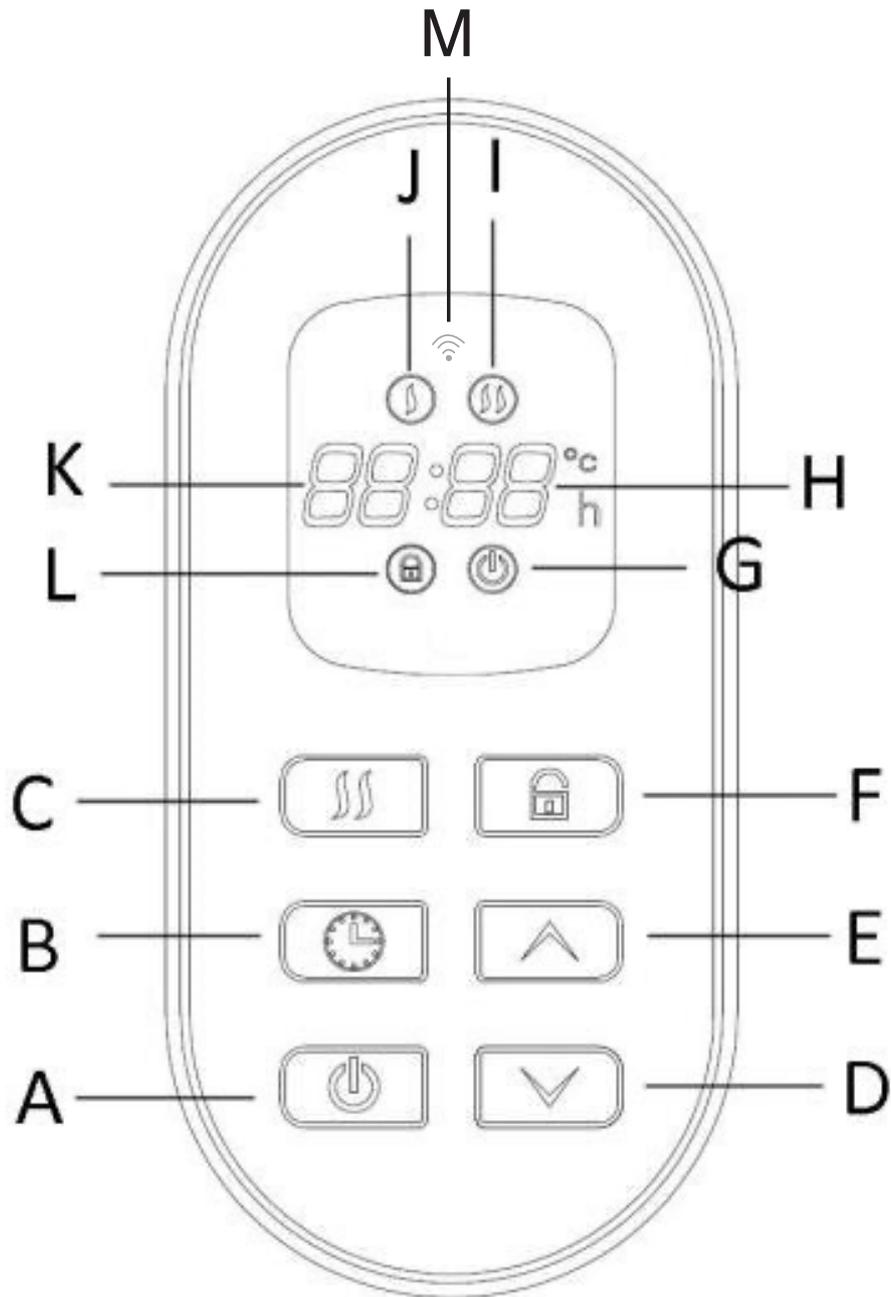

### Touch Controls

- |                                   |  |
|-----------------------------------|--|
| <b>A.</b> On/off button           | <b>H.</b> Set temperature or timer display |
| <b>B.</b> Timer button            | <b>I.</b> High heat                        |
| <b>C.</b> Power setting           | <b>J.</b> Low heat                         |
| <b>D.</b> Temperature setting (-) | <b>K.</b> Room temperature display         |
| <b>E.</b> Temperature setting (+) | <b>L.</b> Child lock icon                  |
| <b>F.</b> Child lock              | <b>M.</b> Wi-Fi icon                       |
| <b>G.</b> Main power icon         |  |



## Remote Controls

- 1. On/Off button
- 2. Power setting button
- 3. Temperature control button
- 4. Time control button
- 5. Child lock function button

## Plugging in the Appliance

Before plugging the appliance into the mains, ensure that your supply voltage is the same as what is shown on the rating plate of the appliance.

Avoid contact between the heater and clothes, household linen, furniture, inflammable materials.

## Fuse Replacement & Wiring Instructions

### **This appliance must be earthed (Class I)**

This appliance is supplied fitted with a BS1363 mains plug and a BS1362 fuse.

If the plug is removed from the appliance, please ensure it is disposed of safely as a disconnected plug is dangerous if reconnected to the mains.

If any other type of plug is used a suitable fuse must be fitted.

The wires in the main lead are coloured in accordance with the following code:

**BLUE = NEUTRAL**

**BROWN = LIVE**

**GREEN/YELLOW = EARTH**

As the colours of the wire in the mains lead of this appliance may not correspond with the colour marking identifying the terminals on your plug, proceed as follows:

The wire that is coloured **BLUE** must be connected to the terminal marked with the letter N

The wire that is coloured **BROWN** must be connected to the terminal marked with the letter L

The wire that is coloured **GREEN/YELLOW** must be connected to the terminal marked with the letter E or symbol 

## Operation

Plug the appliance into an appropriate electrical outlet. Turn on the appliance by pressing the main power switch on the side of the appliance. A beep sound will be heard, the appliance is now in standby mode. Press the on/off button  to turn the heater on.

## Power Setting

Press the power setting button  to choose the desired power setting - if the display shows  then low heat is selected, and if the display shows  then high heat is selected.

## Temperature Setting

Press temperature setting button  or  to set the desired temperature between 5°C and 40°C. When the desired temperature has been set, it will show on the display panel.

## Time Setting

### How to use the timer to switch off the appliance:

1. Plug the appliance into a suitable wall socket, then switch the appliance to standby mode by pressing the main power button located on the side of the appliance.
2. The appliance will beep to indicate it is in standby mode.
3. Press the on/off  button to switch on the appliance.
4. Press the timer button  to increase the time in 1 hour increments between 1-24 hours until the desired time is reached.
5. The selected time will flash on the screen to indicate that the timer has been set - the screen will then revert to showing the ambient temperature.
6. Once the desired time is reached, the appliance will switch off automatically.

**Note:** You can review the selected turn off time at any point by pressing the timer button; the set time will flash on the screen for a few seconds before reverting back to the ambient temperature.

## Child Lock

Long press the child lock button  firmly for 5 seconds until a beep sound is heard; this will activate the child lock function. The  symbol will show on the control panel to indicate when the child lock function is activated. Long press the child lock button firmly for another 5 seconds until a beep sound is heard; this will deactivate the child lock function.

## Turn Off

Press the on/off button  again to turn off the appliance before turning off the main power switch and disconnecting from the mains power.

**Note:** The operating instructions above apply to both the **Remote Control** supplied with the heater and the **Controls/Display** on the front of the heater.

## Connecting to Wi-Fi

### Download the Tuya app:

Scan the code below to go to the app. Press install and follow the app's Instructions to create an account.



### Pairing your device:

1. Switch on the product.
2. The Wi-Fi indicator light  will rapidly blink. If the indicator light does not rapidly blink press the  button for 5 seconds on the heater.
3. With the Wi-Fi indicator flashing go to the App and tap + or "add device"  
The app should now start scanning as shown by the icon on the screen.
4. The app may ask you to choose your Wi-Fi network. Please enter your details and press "Next". The app will demonstrate that it has now found the radiator (see below). Press "Add" then tap the + icon.

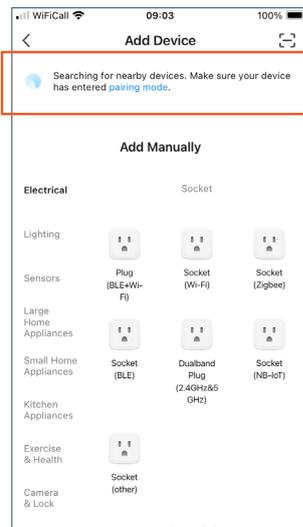
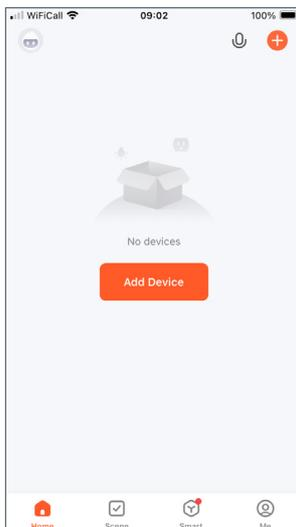

5. Once the radiator is successfully connected it will appear on the app. Press  icon to change the name of the radiator or "Done" to return to the Home screen.

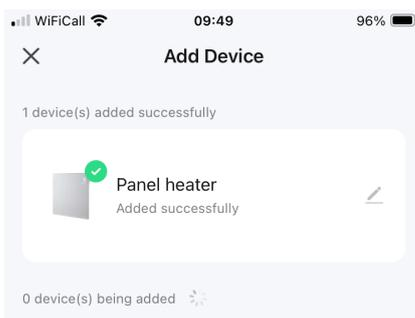

## Pairing Your Device Secondary Method

Note: if you are using a VPN, make sure this is disabled before continuing and ensure that a 2.4GHz Wi-Fi band is enabled for this device. This method requires Bluetooth connectivity.

Once you are on the home page of the Tuya Smart app, Press the plus button ' + ' on the top right hand side of the app.

Under the 'Add Manually' menu, select the "Small Home Appliances" category on the left-hand side of the app. Then select "Heater (Wi-Fi)" from the devices list.

Enter the Wi-Fi password for the network your mobile/tablet is currently connected to and then press the 'next' button.

Press and hold the pairing button on your device for 5 seconds, the Wi-Fi connection indicator  will begin to flash rapidly.

Select the 'Confirm the indicator is blinking rapidly' option on the App, then press the 'next' button to begin the pairing process.

Shortly into the pairing process, the flashing Wi-Fi light will stop flashing and become stable. This indicates that the device has joined the network.

Once the pairing process is complete, you can rename the device as required or press 'Done' to complete the pairing process.

Note: if the pairing process was not successful, follow the procedure again ensuring that the conditions for pairing have been met.

## Smart Home Assistant For Smart Home Assistant services such as Google Home or Amazon Alexa

Follow the on-board instructions on the TuyaSmart App. This can be found under the 'Me' section on the home page of the App.

Note: The Smart Home Assistant services supported by the TuyaSmart App may change as it is a 3rd party App Service.

Any services that may be removed are the responsibility of TuyaSmart developers and not Osily.

## Reset to Default Settings

When in STAND BY mode, press and hold the On/Off button  to reset your radiator and reinstall the original factory configuration.

The full screen will display for 3 seconds and then go to stand by press  to turn on the radiator.

## High and Low Temperature Alarm

PROBLEM	CODE
The room temperature sensor is disconnected or the room temperature is too low	Err 1
The room temperature sensor is short-circuited or the room temperature is too high	Err 2

## IV/ Maintenance

### TURN OFF THE UNIT BEFORE ANY MAINTENANCE.

Clean with a soft damp cloth.

### Always disconnect the appliance and let it completely cool before any maintenance.

Clean your appliance at least once a year with a vacuum cleaner to remove any dust deposits when switched off and unplugged.

Never immerse the device in water or any other liquid.

The coating of you radiator ensures perfect and unalterable protection. To clean it, use only a neutral detergent (cleaner or non-abrasive solvent). The thermostat housing is made of plastic. do not use solvents for maintenance.

Any repair must be carried out by the manufacturer, it's representatives or by the after-sales service.

## WARNING

Never cut the power cable supplied with your radiator, if it is cut, the electrical part of the radiator cannot be guaranteed. Never try to open the radiator even when it is not electrically powered.

## IMPORTANT

Temperature changes are normal when using an electric thermostat in case of electrical changes, or changes in ambient conditions outside the room. The set value is correct for radiators installed in standard environments. It is normal for the regulation to be different for the same temperature in two different atmospheres (environmental influence).

## Disposal



For end of life disposal of this product please do not dispose of with household waste. Please recycle where facilities exist. Check with your Local Authority or supplier for recycling information.

## Warranty

This product is guaranteed under warranty and covers defects in material or workmanship for 2 years from the date of purchase. The warranty will not apply in cases of: Misuse: by non-compliance of the instructions, normal wear and tear, incorrect use, e.g. overloading, non-approved accessories, force or damage caused by external forces, if the plug has been tampered with or removed, partially or completely dismantled product, or interference by non-qualified persons.

TECHNICAL SPECIFICATION			
Model	OSPH1000E-WIFI	OSPH1500E-WIFI	OSPH2000E-WIFI
Voltage	220-240V AC /50Hz	220-240V AC /50Hz	220-240V AC /50Hz
Wattage	1000W	1500W	2000W
Operating Current (A)	4.3	6.5	8.7
Set Temperature Range	5-40°C	5-40°C	5-40°C
Set Temperature Resolution	1°C	1°C	1°C
IP Rating	IP24	IP24	IP24
Earthing Class	Class I	Class I	Class I
Motion Sensor (5.8G band) Operation frequency Max RF power transmitted	5725-5875MHz 5.28 dBm (3.37W) <13.98 dBm (25mW)	5725-5875MHz 5.28 dBm (3.37W) <13.98 dBm (25mW)	5725-5875MHz 5.28 dBm (3.37W) <13.98 dBm (25mW)
Wi-Fi Frequency (2.4G band) Operation Frequency Max RF power transmitted	2400-2483.5MHz 17.21 dBm (52.6W) <20 dBm (100mW)	2400-2483.5MHz 17.21 dBm (52.6W) <20 dBm (100mW)	2400-2483.5MHz 17.21 dBm (52.6W) <20 dBm (100mW)

ERP INFORMATION

Model	OSPH1000E-WIFI	OSPH1500E-WIFI	OSPH2000E-WIFI
Nominal heat output (P <sub>nom</sub> /kW)	1.0	1.5	2.0
Minimum heat output (indicative) (P <sub>nom</sub> /kW)	0.5	0.7	1.0
Maximum continuous heat output (P <sub>max.c</sub> /kW)	1.0	1.5	2.0
At nominal heat output (el <sub>min</sub> /kW)	N/A	N/A	N/A
At minimum heat output (el <sub>min</sub> /kW)	N/A	N/A	N/A
In standby mode (el <sub>SB</sub> /W)	0.00106	0.00106	0.00106



## UK PSTI STATEMENT OF COMPLIANCE

Osily as manufacturer, hereby declare, that the below product(s) covered in this document are in conformance with the applicable security requirements in Schedule 1 of The Product Security and Telecommunications Infrastructure (Security Requirements for Relevant Connectable Products) Regulations 2023 ("Security Requirements").

Product Type	Slimline Panel Heater with Wi-Fi control
Models	OSPH1000E-WIFI. OSPH1500E-WIFI. OSPH2000E-WIFI
UK Defined Support Period	2 years (until 31/03/26)
Manufacturer's Name	Osily
Manufacturer's Address	AER, Zac du Caillou, Rue Jules Verne, 69630, Chaponost, France

This statement of compliance is prepared by or on behalf of the manufacturer of the product:

Name: P. Staniforth

Title: Technical Manager

Signature: *P Staniforth*

Place: Yesss House. Foxbridge Way. Normanton. WF6 1TN

Date: 8<sup>th</sup> April 2024

Please note that this statement of compliance, including the Defined Support Period stated herein, is only applicable to products sold in the UK.