

zappi

eco-smart EV charge point



User Manual

MODELS:

ZAPPI-2H07UW-G

ZAPPI-2H22UW-G

ZAPPI-2H07UB-G

ZAPPI-2H22TW-G

ZAPPI-2H07TW-G

ZAPPI-2H22UB-G

ZAPPI-2H07TB-G

ZAPPI-2H22TB-G

Contents

| | | |
|------|--|----|
| 1. | Introduction | 5 |
| 2. | Safety | 5 |
| 3. | Disposal | 5 |
| 4. | Copyright | 5 |
| 5. | Overview | 6 |
| 5.1 | Overview Diagram | 6 |
| 6. | Box Contents | 8 |
| 7. | WiFi Set-up | 8 |
| 8. | Product Registration | 10 |
| 8.1 | First Time User? Register for an Account | 10 |
| 8.2 | Existing Users | 10 |
| 9. | Operation | 11 |
| 9.1 | Controls & Indicators | 11 |
| 9.2 | RGB Indicator Key | 12 |
| 9.3 | Display | 12 |
| 9.4 | Status Screens | 13 |
| 10. | Charging Modes | 15 |
| 11. | Manual Boost | 16 |
| 11.1 | Activating Boost | 16 |
| 11.2 | Cancelling Boost | 16 |
| 12. | Smart Boost | 16 |
| 12.1 | Activating Smart Boost | 17 |
| 12.2 | Cancelling Boost | 17 |
| 12.3 | Programming the Smart Boost Values | 17 |
| 13. | Boost Timer | 18 |
| 13.1 | Programming Boost Times | 18 |
| 13.2 | Economy Tariff Boosting | 18 |
| 13.3 | Boost Time Conflicts | 18 |
| 14. | Lock Function | 19 |
| 14.1 | Socket Lock | 19 |
| 15. | Configuration Settings | 20 |
| 15.1 | Time & Date | 20 |
| 15.2 | Display & Sound | 20 |
| 15.3 | RGB LED | 20 |
| 15.4 | Grid Limit | 20 |
| 15.5 | CT Detect ("G100") | 20 |
| 16. | Advanced Settings | 21 |
| 16.1 | Supply Grid - Device Settings | 21 |
| 16.2 | Device Limit | 21 |
| 16.3 | Neutral Limit | 21 |
| 16.4 | Earthing | 21 |
| 17. | Supply Grid - Network Settings | 22 |
| 17.1 | Grid Limit/Load Curtailment | 22 |
| 17.2 | Battery | 22 |
| 17.3 | Net Phases | 22 |
| 17.4 | Export Margin | 23 |

| | | |
|------|---|----|
| 17.5 | CT Config | 23 |
| 17.6 | CT Detect Protection..... | 24 |
| 17.7 | CT Groups..... | 24 |
| 17.8 | Group Limits..... | 24 |
| 18. | Preconditioning | 25 |
| 18.1 | Setting Preconditioning | 25 |
| 19. | eSense | 26 |
| 20. | myenergi app..... | 27 |
| 20.1 | Setting Priorities..... | 27 |
| 21. | Troubleshooting..... | 30 |
| 22. | Fault Codes | 31 |
| 23. | Warranty | 32 |
| 24. | Technical Specifications..... | 33 |
| 24.1 | Performance..... | 33 |
| 24.2 | Electrical Specifications..... | 33 |
| 24.3 | Mechanical Specifications | 33 |
| 24.4 | Connectivity | 33 |
| 24.5 | Max Transmitted Power | 33 |
| 25. | Model Variants..... | 34 |
| 26. | Technical Support..... | 34 |
| | Appendix A..... | 35 |
| 1. | Electric Vehicles (Smart Charge Points) Regulations 2021..... | 35 |
| 1.1 | Purpose of the Regulations..... | 35 |
| 1.2 | What's changed with zappi..... | 35 |
| 1.3 | Randomised Delay: How it works..... | 35 |
| 1.4 | Smart Scheduling: How it works..... | 36 |
| 1.5 | Defaulting to 'ECO+' Mode..... | 36 |
| 1.6 | Charging Logs..... | 37 |
| | Appendix B..... | 38 |
| 2. | Electric Vehicles (Smart Charge Points) Regulations 2021..... | 38 |
| 2.1 | Purpose of the Regulations..... | 38 |
| 2.2 | What's changed with zappi..... | 38 |
| 2.3 | Automatic Firmware Checking..... | 39 |
| 2.4 | Tamper Detection..... | 39 |
| 2.5 | AES Encryption..... | 39 |
| 2.6 | Installer Requirements | 40 |

NOTICE

The UK Government's Electric Vehicle (Smart Charge Points) Regulations 2021 have been introduced. Please ensure you read this manual fully before installing. Processes and features have changed.

Electric Vehicles (Smart Charge Points) Regulations 2021

From 30th June 2022, any EV charger installed in a private setting i.e. home or workplace, NOT public, in England, Scotland and Wales has to meet the Electric Vehicles (Smart Charge Points) Regulations 2021.

From 30th December 2022, further regulations come into force.

To ensure all our zappis are compliant by the date the regulations come into force we will be taking a phased approach with the implementation of certain features.

For information on how these new regulations may affect you and your myenergi zappi please read the appended information at the back of this manual.

Appendix A - (Electric Vehicle Smart Charge Points) Regulations 2021 – Regulations as of 30th June 2022

This Appendix is relevant to all zappis INSTALLED on or after the 30th June 2022

Appendix B - (Electric Vehicle Smart Charge Points) Regulations 2021 – Regulations as of 30th December 2022.

This appendix is relevant to zappis INSTALLED on or after 30th December 2022.

1. Introduction

Thank you for choosing zoppi. Of course, we think you have made an excellent choice and are sure you will be incredibly happy with the features, benefits, and quality of your myenergi product.

These instructions will help you to familiarise yourself with the zoppi. By reading the instructions, you will be sure to get the maximum benefit from your 'eco-smart' device.

2. Safety

zoppi is an AC EV charger, intended to be installed in a fixed location and permanently connected to the AC supply network. It is a Class 1 item of electrical equipment in accordance with IEC 61140.

The unit is designed for indoor or outdoor use at a location with restricted access and should be mounted vertically either surface (wall) mounted or on the dedicated pole mount supplied separately by myenergi.

The device has been manufactured in accordance with the state of the art and the recognised safety standards, however, incorrect operation or misuse may result in:

- Injury or death to the operator or third parties
- Damage to the device and other property of the operator
- Inefficient operation of the device

All persons involved in commissioning, maintaining, and servicing the device must:

- Be suitably qualified
- Have knowledge of and experience in dealing with electrical installations
- Read and follow these operating instructions carefully
- Always disconnect the device from the supply before removing the cover

The device is not to be used by persons (including children) with reduced physical, sensory, or mental capabilities, or lack of experience and knowledge, unless they have been given supervision or instruction concerning use of the device by a person responsible for their safety.

zoppi comes in either tethered or untethered variants. The untethered version should only be used with a dedicated cable fitted with a Type 2 plug which is compliant with EN 62196-1 and EN 62196-2. Adaptors or conversion adaptors and cord extension sets are not allowed to be used.

Failure to install and operate the zoppi in accordance with these instructions may damage the unit and invalidate the manufacturer's warranty.

3. Disposal

In accordance with European Directive 2002/96/EC on waste electrical and electronic equipment and its implementation in national law, used electrical devices **must** be collected separately and recycled in an environmentally responsible manner. Ensure that you return your used device to your dealer or obtain information regarding a local, authorised collection and disposal system. Failure to comply with this EU Directive may result in a negative impact on the environment.

4. Copyright

Copyright of these operating instructions remains with the manufacturer. Text and images correspond to the technical level at the time of going to press. We reserve the right to make changes. The content of the operating instructions shall not give rise to any claims on the part of the purchaser. We are grateful for any suggestions for improvement and notices of errors in the operating instructions.

myenergi zoppi, myenergi eddi and myenergi harvi are registered trademarks of myenergi Ltd.

5. Overview

Microgeneration systems such as Solar PV and small wind turbines are at their most efficient when the generated energy is consumed on-site rather than exporting it to the grid. This is what we call 'self-consumption'.

zappi is a Mode 3 charging station, compatible with all electric vehicles that comply with EN 62196 and EN 61851-1 plug-in electric vehicle standards.

zappi works like any regular charging point but has special ECO charging modes that will benefit homeowners with grid-tied microgeneration systems e.g. wind or solar generation. Two special ECO charging modes automatically adjust charging current in response to on-site generation and household power consumption. In FAST charge mode, zappi operates like an ordinary EV charger.

A grid current sensor (supplied) simply clips around the incoming supply cable and is used to monitor excess power. When using the special ECO charge modes, zappi will automatically adjust the charge rate in response to available surplus.

Feature Set

- 3 charging modes: ECO, ECO+ & FAST
- Optimises microgeneration self-consumption
- Works with solar PV, wind turbine or micro-hydro systems
- Economy tariff sense input
- Programmable timer function
- Charge and event logging
- Remote control and monitoring add-on option
- Pin-code lock function
- Tap operated display backlight
- Built-in protection against the loss of the protective neutral and earth (PEN) conductor as required by BS 7671:2018 Amendment 1:2020(The “Wiring Regulations”)
- Ethernet connector (for local communications between myenergi devices)
- Integral cable holster (tethered units)
- Supplied with 1 x clip-on grid current sensor (x3 if purchasing a 3-phase unit)
- Illuminated display – for convenience, the display can be illuminated by simply tapping the zappi front cover.
- Integrated WiFi for connecting to internet.
- Front Lid Tamper Detection

5.1 Overview Diagram

The diagram on the next page shows the zappi as part of a complete energy management system. Other myenergi products are shown with details of how they integrate with the grid connection and the microgeneration system.

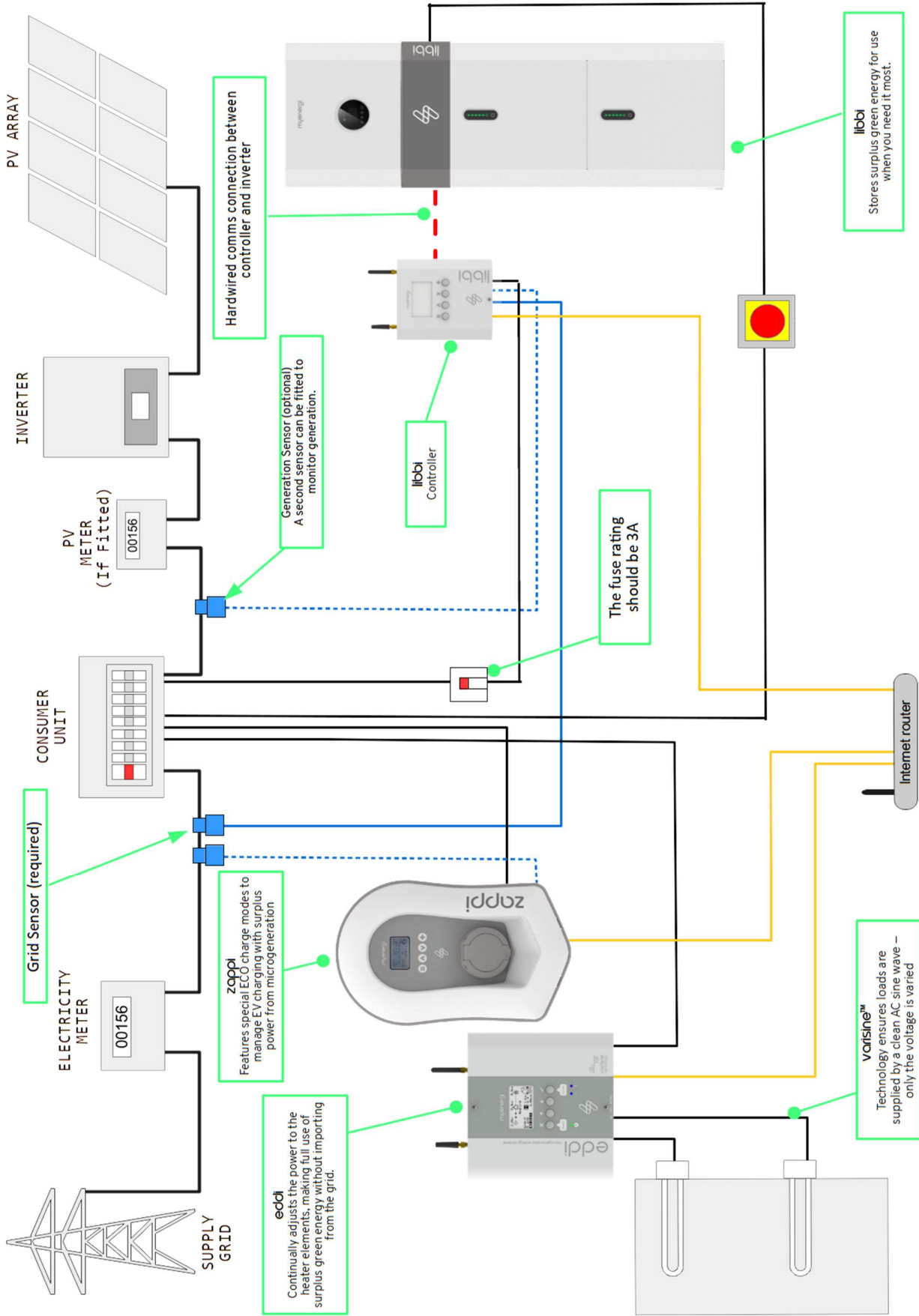

6. Box Contents

Tethered Units

- 1 x zappi unit with EV cable and connector attached
- 1 x Cable wall guard
- 1 or 3 x CT clamps¹
- 1 x Mounting template
- 1 x Mounting kit for a brick wall

Mounting kit (Tethered units)

- 4 x 50mm Pozi screws
- 4 x Wall mounting plug
- 4 x Sealing washer
- 4 x 12mm Pozi screws (countersunk)

Untethered Units

- 1 x zappi unit
- 1 or 3 x CT clamps¹
- 1 x Mounting template
- 1 x Mounting kit for a brick wall

Mounting kit (Untethered units)

- 4 x 50mm Pozi screws
- 4 x Wall mounting plug
- 4 x Sealing washer

7. WiFi Set-up

If WiFi was not available during your installation, your installer may have skipped this step. As soon as you have WiFi availability you can connect by following the steps below.

It is important to connect your zappi to the internet to install the latest firmware and receive any future firmware updates.

Step 1: Firstly, turn on the Access Point by navigating to *Menu > Other Settings > Internet > WiFi > WiFi Information* on your zappi device display. If Access Point is showing as “Off”, turn to “On”.

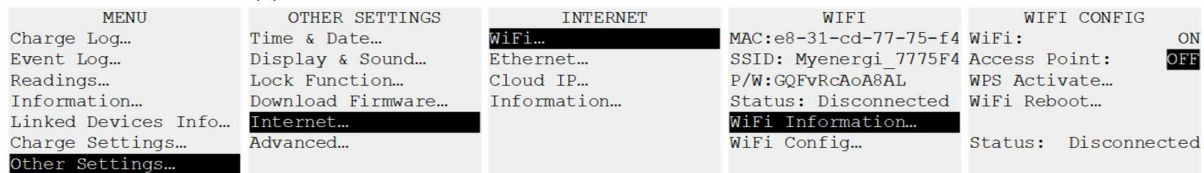

Step 2: Once the Access Point is set to “On”, go back to the “WiFi” page by pressing the (≡) button.

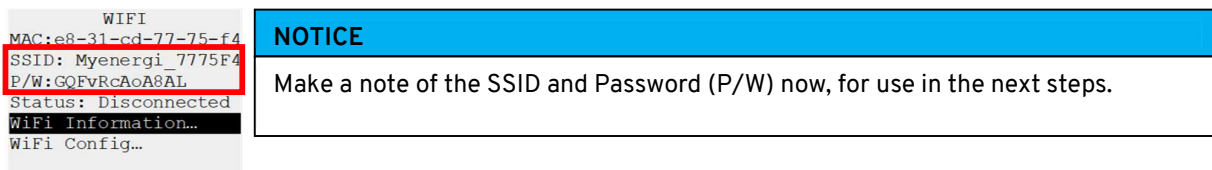

Step 3: Connect your smartphone or computer to the myenergi access point by entering your phone or computer WiFi Settings and searching for the network displayed with the same name as the SSID you noted down above. Once displayed, select the network to connect.

Step 4: You will be prompted for a password.

Enter the password displayed on the zappi screen that you noted down at step 2.

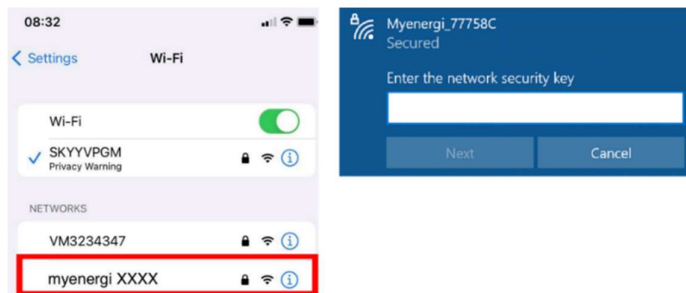

¹ 1xCT clamp supplied with single phase zappi; 3xCT clamps supplied with three phase zappi

Step 5: You will now be prompted to create a new password to protect the WiFi settings from being changed by anyone else. The new password must be at least 8 characters long and consist of a combination of lowercase and uppercase letters and digits.



The image shows a black screen with white text for 'myenergi WiFi Setup'. It prompts the user to 'Please set a password to protect your WiFi settings'. There are three input fields: 'Enter new password', 'Confirm Password', and 'Confirm password'. A 'Set' button is located at the bottom.

NOTICE

If page doesn't load, type 192.168.4.1 into your web browser or mobile phone browser to enter WiFi setup screen.

Step 6: Wait 5 seconds for your password to change and the webpage to reload.

Step 7: Once connected, you will be directed to the webpage below where you will need to select your home WiFi network from the list in the "Detected Networks" box and type in your home WiFi's password to connect to your router.

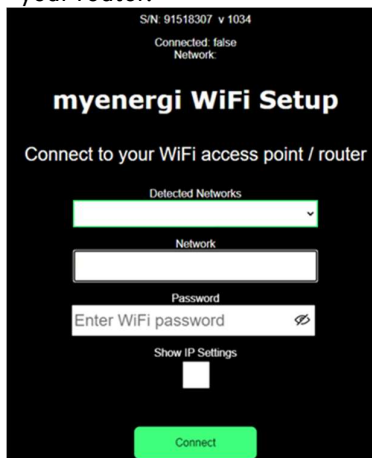

The image shows a black screen with white text for 'myenergi WiFi Setup'. It prompts the user to 'Connect to your WiFi access point / router'. There are several input fields: 'Detected Networks' (a dropdown menu), 'Network', 'Password', and 'Enter WiFi password'. There is also a 'Show IP Settings' checkbox and a 'Connect' button at the bottom.

NOTICE

In most cases you should leave the "Show IP Settings" option unticked. However, if you want to give your zappi a fixed IP address then tick the "Show IP Settings" box and fill in the extra information required.

NOTICE

Please be patient. It could take up to 15 seconds for the connection to take place.

Step 8: Once complete, check WiFi is connected. Do this by navigating back to the WiFi Config Menu as you did at Step 1. Check Status is showing as "Connected".



The image shows a grey screen with black text for 'WIFI CONFIG'. It lists several settings: 'WiFi: ON', 'Access Point: ON', 'WPS Activate...', and 'WiFi Reboot...'. The 'Status:' is highlighted with a red box and shows 'Connected'.

8. Product Registration

8.1 First Time User? Register for an Account

If this is your first myenergi device your installer will talk you through the following simple steps to get your account up and running.

Step 1: Download the myenergi app



Android users can download the myenergi app on Google Play



Apple users can download the myenergi app in the App Store

1. Open the app and click, 'Register for an account'.
2. Enter an email address and create a password, when prompted.
3. Select your contact preferences then click 'next'.
4. Check the email you registered with for a verification code.
5. Enter the code into the app, where requested and press 'next'

Step 2: Set your location and add your first device

1. In the app click the green '+' symbol to add your first location.
2. When asked if you have a 'hub' select, 'No' as this is your first device which already has a built-in virtual hub (vHub).
3. Enter the 'Reg S/N' and 'Reg code' (These can be found in your zappi device settings; *menu > Information > Page 2.*).
4. Once complete, your device will now display in your myenergi account and app.

Step 3: Customer Details

1. Visit myaccount.myenergi.com from a web browser.
2. Log in with the same credentials used to register for the app.
3. Click on 'My Dashboard'.
4. In the section titled 'Finish setting up your account', click 'Add account details'.
5. Click 'Edit personal info' and complete the form with the required information.
6. Click, 'Submit'.

Congratulations! You're all set. You can now use the myenergi app and myaccount to monitor your energy consumption in real time, wherever you are in the world.

8.2 Existing Users

Already have a myenergi device and registered account?





1. Your installer will pair your new device to your existing system.
2. You will see your new device is automatically added to your myenergi account and app.



9. Operation

9.1 Controls & Indicators



| | | |
|----|--|---|
| 1. | Display | Graphical LCD display with LED backlight <ul style="list-style-type: none"> Backlight can be activated by tapping the unit. |
| 2. | Front Fascia | Remove fascia for installing and servicing |
| 3. | Tethered Charging Cable if applicable | 6.5-metre cable with a Type 2 plug or Type 2 socket with locking system for untethered models. |
| 4. | Control Buttons | Four tactile buttons used to navigate the menus and alter settings: <ul style="list-style-type: none">  Menu  Change charge mode Move up a menu item Increase value  Change charge mode Move down a menu item Decrease value  Boost Select item Confirm value and move to next setting. |
| 5. | Integrated Cable Holster (tethered units only) | When not in use, the charging cable should be wrapped around the unit and secured in the cable holster (tethered units). |
| 6. | Charging Connection Point (untethered units) | When cable not in use, the charging cable should be unplugged and stored in a cool dry place. |
| 7. | RGB Indicator | Visual Indicator that changes colour dependant on the zappi's charging state. (See 9.2 for key) |

9.2 RGB Indicator Key

The lighting flash indicator on the front of the Zappi indicates the status of the charge. The default colours are:

| | |
|---------|-----------------------------------|
| Pink: | Connected |
| Green: | Charging 100% Green |
| White: | Charging from Grid only |
| Yellow: | Charging mix of grid/green energy |
| Blue: | Charge complete |
| Red: | Error |

These colours can be adjusted on Display & Sound menu (firmware version 2.163 onwards).

The colour effect (pulsing of the LED brightness) varies according to the charging power.

9.3 Display

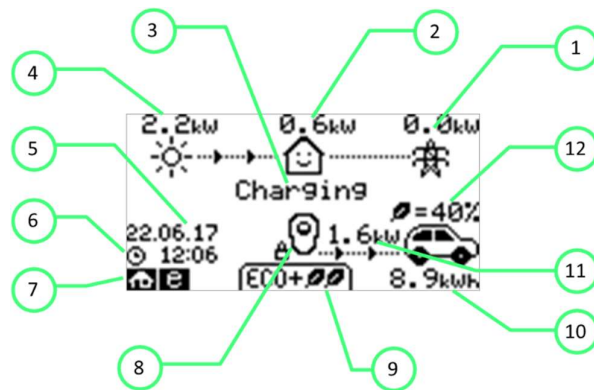

| | | |
|----|-----------------------|---|
| 1. | Import / Export Power | The power being either imported or exported from or to the grid (kW). The direction of the arrows indicates if the property is currently importing power (left) or exporting power (right). The size of the arrows is proportionate to the level of power being imported / exported, When the property is neither importing or exporting power the figure will be 0.0kW and there will no animated arrows. The property is then said to be 'in balance'. |
| 2. | House Load Power | The power that the property is currently using in kW. (Note: This is displayed only when the Generation Sensor is installed directly to a CT input or a harvi or other myenergi device) |
| 3. | Status Text | The current status is displayed here (see Status Screens) |
| 4. | Generation Power | The power being generated at this time in kW. (Note: This is displayed only when the CTs are installed either hard wired to the CT inputs of the zappi or wirelessly to a harvi or other myenergi device) |
| 5. | Lock Icon | Operation lock is active. |
| 6. | Date & Time | The current date and time. |
| 7. | Mode Icons | These icons indicate that the import limiting is active (house), Demand Side Response (~) or the eSense input is live (e) |
| 8. | zappi Icon | If you see wavy lines above the zappi icon, the unit is thermally limiting! The output power is temporarily reduced. |

| | | |
|-----|----------------------------|---|
| 9. | Charge Mode | Shows the selected Charging Mode; FAST, ECO or ECO+ (see Charging Modes) |
| 10. | Charge Delivered to EV | The accumulated charge energy that has been sent to EV in this charge session. |
| 11. | Current Charging Power | When the EV is charging, arrows will show here along with the charging power in kW. |
| 12. | Green Level of Last Charge | This is the percentage of 'Green' energy for the last charge session, this is shown at the end of a charge or when the EV is unplugged. |

9.4 Status Screens

9.4.1 EV Disconnected

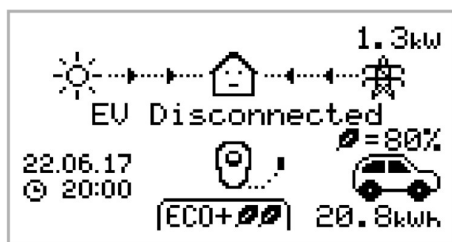

The EV is not connected to zappi.

In this example the last charging session delivered 20.8kWh of energy to the EV and 80% of that energy came from the solar panels.

9.4.2 Waiting for Surplus

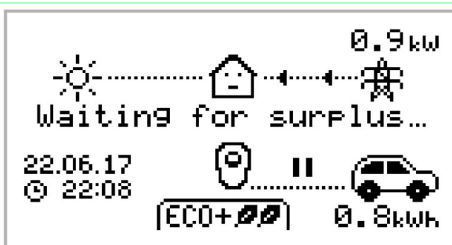

zappi is waiting for sufficient surplus power from the microgeneration system. This screen will be shown in ECO+ mode as it is only in this mode that charging will stop if there is not enough surplus power.

The house in the centre is straight-faced as grid electricity is being used by the house (0.9kW in the example shown).

9.4.3 Surplus

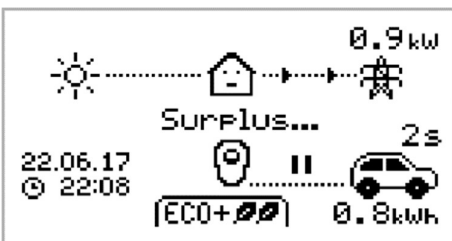

Enough surplus is available and zappi is about to charge the EV. A timer is decremented and can be set in the charge settings (ECO+ mode only).

9.4.4 Waiting for EV

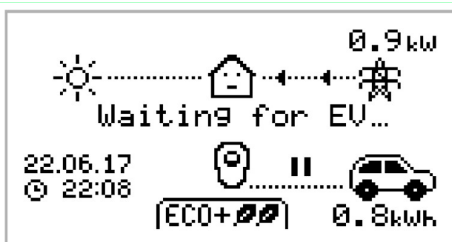

zappi is waiting for the EV to respond; the EV is not ready to accept charge.

9.4.5 Charge Delayed

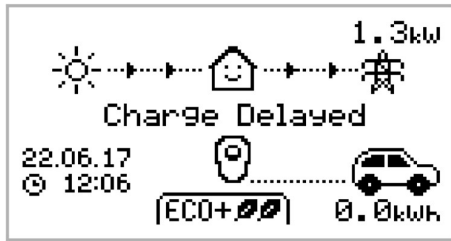

The charging session has been delayed by the EV because a scheduled charge has been set in the vehicle.

9.4.6 Paused

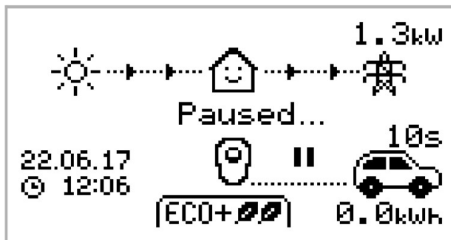

zappi is paused for a few seconds in order to limit the start/stop frequency during ECO+ mode charging.

9.4.7 Charging

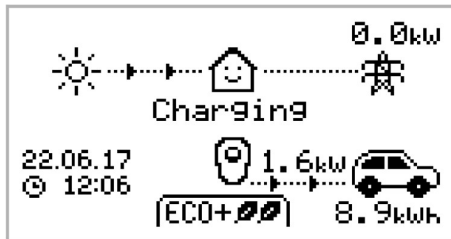

The EV is charging.

In this example the car is charging in ECO+ mode at 1.6kW, there is no import or export from the grid (0.0kW) and the EV battery has charged by 8.9kWh since the car started.

9.4.8 Charge Complete

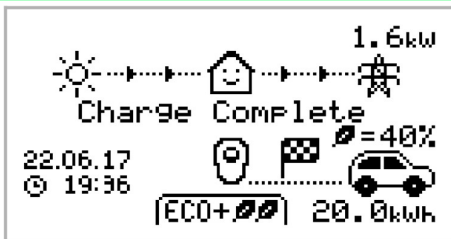

The EV is fully charged.

The charge energy used during the last charge is displayed at the bottom right (20.0kWh in this case) and the 'green contribution' is also shown (40% in this example).

9.4.9 Restart



zappi is performing a restart sequence.



This may happen with some EVs that need to be 'woken-up' to start charging after a pause in the charge. Charge should start immediately afterwards, otherwise the "Charge Delayed" message will appear.

9.4.10 Stopping



zappi is about to stop the EV charging

10. Charging Modes

zappi has three different charging modes and a “STOP” mode which can be selected simply by pressing the  and  buttons when the main screen is showing. The charge mode can be changed before or during a charge. Regardless of the charge mode, all the surplus electricity is used. zappi’s special eco charge modes limit the amount of grid electric used. Below is the explanation of each charging mode.



Charges at the fastest rate

Fast Mode will charge the EV at the fastest rate and will import grid electricity if there is insufficient surplus generated power. The actual charge rate is dependent on the EV's onboard charger and the grid supply voltage. Some vehicles can charge at 11kW or 22kW on a 3-Phase zappi, but many EV's have lower charge rates. The maximum charge rate for the single phase zappi is 7kW.

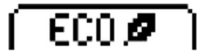

Adjusts the charge rate to limit the use of grid electricity

The charge rate is continuously adjusted, in response to changes in generation or power consumption elsewhere in the home, thereby minimising the use of grid power. Charging will continue until the vehicle is fully charged, using available surplus power. If at any time, the available surplus power falls below 1.4kW, the shortfall will be drawn from the grid.

Note: The EV charging standard does not support below 1.4kW.

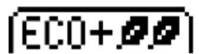

Adjusts the charge rate to limit the use of grid electricity and will pause the charge if there is too much or any grid electricity being used (Set-up Dependant)

The charge rate is continuously adjusted, in response to changes in generation or power consumption elsewhere in the home, thereby minimising the use of grid power. Charging will pause if there is too much imported power, continuing only when there is enough surplus power available. The surplus power threshold at which the charge will start or stop can be set using **Min Green Level** in the **ECO+ Settings** of the **Charge Settings** menu. The actual green contribution percentage is shown when the charge is complete or when the zappi has been disconnected from the EV. It is possible to charge the EV using only surplus renewable power, if there is sufficient surplus power available and a boost option has **not** been set. (**Please note: The EV charging standard does not support charging below 1.4kW**) Example: when zappi is set to a Min Green Level of 100% you will need in excess of around 1.4kW of surplus energy available to start the charge. If the surplus falls below the 1.4kW threshold the charge will pause until the threshold is once again met. After a short delay zappi will resume charge. If preferable, you can set the zappi to share power from the grid and a generation source to ensure a charge is always maintained. For example, the Min Green Level could be set to 75%. A charge will then start when there is a surplus of 1.05kW, taking a further 0.35kW from the grid. It is worth noting that this is only required to start a charge. If a higher amount of surplus becomes available it will be consumed, resulting in less being drawn from the grid.



The output from zappi is turned off

In STOP mode zappi will not charge your EV. **This includes the boost modes and timed boost.** zappi will continue to measure power and communicate with the other myenergji devices.

11. Manual Boost

The Manual Boost function can only be used when charging in ECO or ECO+ mode. When boosting, the charge rate is set to maximum (just like FAST mode), until a set amount of energy has been stored in the EV's battery. After which, Zappi will revert to ECO or ECO+ mode.

This function is useful if you arrive home with an almost flat battery and would like to charge the vehicle immediately to ensure there is enough charge for a short trip if needed.

The amount of energy delivered to the EV during the boost charge can be changed in the Charge Settings/Boost menu.

When in ECO or ECO+ mode, each press of the button will cycle through the boost options as illustrated below:

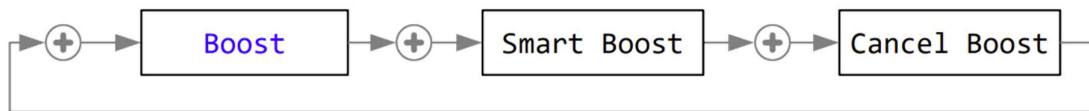

11.1 Activating Boost

1. When charging in ECO or ECO+ mode, press **+** until BOOST is shown.
2. The boost will start after a couple of seconds and the display will show the remaining boost energy

The boost duration can be altered in the Charge Settings/Manual Boost menu option.

11.2 Cancelling Boost

The boost can be cancelled by pressing **+** until Cancel Boost is shown.

12. Smart Boost

The Smart Boost function will charge the EV with a minimum kWh figure by a set time. Smart Boost is available only in ECO and ECO+ modes.

- The Smart Boost function does not bring the battery to a certain state of charge. The target kWh is only the energy added during the charging session.

When in ECO or ECO+ mode, each press of the button will cycle through the boost options as illustrated below:

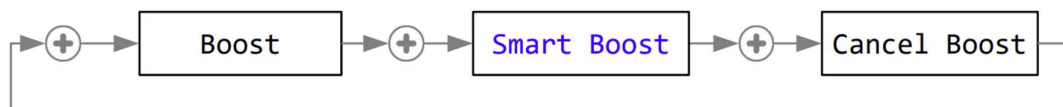

Example: It's a sunny Sunday and you wish to ensure there is enough charge in the EV to get to work in the morning (e.g. 15kWh), but in the meantime, you want to use the surplus energy from the PV system to charge the car, so you choose to use ECO+ mode. At sunset there was only 10kWh of charge accumulated. However, because you activated Smart Boost, and set the time you needed to leave for work, Zappi automatically boosted the charge in the night to top up the battery to the required 15kWh by 7am.

12.1 Activating Smart Boost

1. When charging in ECO or ECO+ mode, press **+** until SMART BOOST is shown.

2. The SMART BOOST icon will show including the target time and the pre-set energy amount.

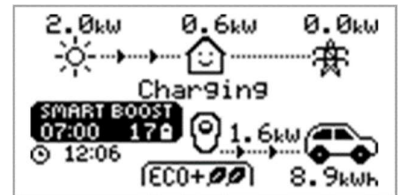

3. zappi will then test the EV for a few seconds, to determine the maximum charge rate.

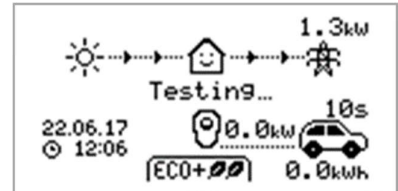

4. The boost will start at the latest possible time to achieve the set energy amount, if the current charge session has already accumulated enough energy, the boost will not be required and so will not operate.

The required energy and target time can be altered only when Smart Boost is not active. These settings are in the Charge Settings/Smart Boost menu option.

12.2 Cancelling Boost

The boost can be cancelled by pressing **+** until Cancel Boost is shown.

12.3 Programming the Smart Boost Values

1. From the main screen, press **≡** to enter Main Menu

2. Select Smart Boost from within the Charge Settings menu. The SMART BOOST screen is then shown

3. The boost can now be edited: Use **▲** or **▼** buttons to edit the target time and amount of charge (kWh) that is required













4. Use **+** to move to the next value, and the **≡** to return to the main screen once the required Smart Boost parameters have been set

13. Boost Timer

When using ECO or ECO+ charge modes, Zappi can be programmed to 'boost' the current charge at certain times. When boosting, the charge rate is set to maximum (just like FAST mode), regardless of the amount of available surplus power. This means that power may be drawn from the mains grid supply during boost times.

- There are four editable time slots which can be set to operate for certain days of the week.
- Setting the duration to 0h00 will make the boost inactive.

13.1 Programming Boost Times

1. From the main screen, press  to enter Main Menu
2. Select Boost Timer from within the Charge Settings menu. The BOOST TIMER screen is then shown.
3. The boost can now be edited: Use  or  buttons to highlight the time slot you wish to change. The lower screenshot shows the start hour being edited:
4. Alter the start hour with the  or  buttons and then press  to move to minutes.
5. Edit the duration in the same way and then press  again to edit the days of the week you want the boost to be active for. Each day of the week can be toggled on/off with  or  buttons. Press  to go to the next day. Pressing  on the last day (Sunday) will confirm the boost time slot and the whole line will be highlighted again.
6. Press  to exit the BOOST TIMER screen.

```
BOOST TIMER
Start Dur Days
07:30 1h30 MTWTF--
08:00 0h15 MTWTF--
12:00 0h00 -----SS
17:00 0h00 -----SS
```

13.2 Economy Tariff Boosting

Boosting only when economy rate electricity is available can be achieved in one of three ways:

1. By setting the boost timer to coincide with the economy tariff times. This option should be used only if the electricity meter is a dual-rate meter (modern meters usually are).
2. Boost only at set times AND if economy rate electricity is available.
3. Automatically boost whenever the economy tariff rate electricity is available, regardless of boost times*

*Options 2 and 3 are available only when using the eSense input.

For option 1, the eSense Input in the Advanced menu should be set to Boost Timer Enable.

With the Boost Timer Enable function set, the BOOST TIMER screen will include an extra column. The e can be toggled on/off. If e is present, the boost will activate only when the boost times are valid and the economy rate tariff is available.

```
BOOST TIMER
Start Dur Days
e 07:30 1h30 MTWTF--
- 08:00 0h15 MTWTF--
- 12:00 0h00 -----SS
- 17:00 0h00 -----SS
```

Alternatively the eSense input can be used to activate the boost whenever the economy tariff rate electricity is available, regardless of boost times (option 2). To do this, the eSense Input option in the Advanced menu should be set to Boost. When using this option, the Boost Timer is not needed.

13.3 Boost Time Conflicts

If one or more boost times conflict, the boost will follow the latest time or longest duration

14. Lock Function

Zappi can be locked from unauthorised operation. The Lock Function requires a PIN number to be entered before the unit can be operated and/or a charge is allowed. The main display can also be hidden when Zappi is locked.

The lock can be set to be active

- Only when the EV is plugged in
- Only when the EV is unplugged.
- All the time.

The settings for the Lock Function can be found in the Other Settings/Lock Function menu option.

| Lock Function Setting | Description |
|--|---|
| EV Plugged | The Lock Function is active when the EV is plugged in, preventing tampering with the charge session, or changing any settings |
| EV Unplugged | The Lock Function is active when the EV is disconnected, preventing unauthorised charging |
| If EV Plugged and EV Unplugged are both set, then the PIN lock is always active. Zappi is effectively locked against any unauthorised use and the PIN code will always be required to make any changes locally or to start a charge. These are the recommended settings if Zappi is mounted in an exposed / publicly accessible location and you do not want anyone else to be able to use it. | |
| Timeout | The time before the Lock Function automatically reactivates after being unlocked |
| Lock Code | This is the current lock code and is five digits from (1 to 4), it can be changed here Default code: 44444 |
| Auto Hide | If set, this will hide the main display of the Zappi to keep the power readings private |
| Charge: | Allow a charge session without the need to enter a pin-code. Useful to leave Zappi access free but with the settings protected. |
| Test | Tests the socket lock solenoid when the charging cable is not plugged in. |
| If Zappi will be used to provide public access for EV charging, then it is recommended to use the following settings: <ul style="list-style-type: none">• EV Plugged - On• EV Unplugged - On• Charge - On• Lock Code - changed to a private PIN number | |

14.1 Socket Lock

For untethered units only, the EV cable will be locked automatically when it is inserted into the Zappi, even if it is not plugged into the EV. A small 'lock' icon will be seen on the right side of the Zappi, in the centre of the screen. When the EV is disconnected, a press of the ⊕ button, will unlock the cable for a duration of 5 seconds, allowing the cable to be removed from Zappi. After this time, the lock will be re-activated.

If the 'Lock Function' (PIN lock) feature is enabled in the Zappi, the cable will not be locked into the socket until the PIN is entered and EV charging starts. This means that if anyone plugs their cable into the Zappi but they do not know the PIN they are able to remove their cable.

In all cases the cable is unlocked if Zappi detects a fault or the power supply to the Zappi is switched off.

15. Configuration Settings

All settings are described in the *Main Menu* section; however, the more commonly altered settings are described in more detail below.

15.1 Time & Date

The date and time are used for the Boost Timer and the savings calculations and therefore should be set correctly. In the event of a power-cut, and providing the Zappi has a connection to the internet the Zappi will update the time and date automatically once the power is restored.

Even if the Zappi does not have an Internet connection its internal clock will continue keep track of the date / time for approx. 24 hours.

Time is always in 24-hour format, but the date format can be changed.

Zappi will automatically adjust the clock for Daylight Savings Time (DST) as long as Auto DST is enabled, and the correct time zone is selected.

The following Time and Date settings are recommended:

- Timezone – set to correct timezone
- Auto DST – On
- Update from Cloud - On

15.2 Display & Sound

The Generation Icon on the Zappi display can be changed to match your local system.

Select between “Sun” (PV) and “Wind” on the Icons... submenu to change the icon

If do not have any local generation then the icon can be turned off by changing the Monitoring... setting

15.3 RGB LED

Zappi has a coloured LED light on the front which changes colour and flashes to provide a visible indication of the charge state. The brightness of the LED and the colours can be adjusted from the RGB LED menu.

15.4 Grid Limit

When the Grid Limit is set, Zappi will automatically reduce the power going to the EV if it detects that too much power is being drawn from the grid.

15.5 CT Detect (“G100”)

“G100” is a UK standard which some distribution companies use when setting the requirements for the Grid Limit (or “load curtailment”) function in EV charging equipment. One requirement is that the equipment should detect if the grid CT is disconnected.

When the CT Detect Protection setting is turned on (default) Zappi will detect that the grid CT has become disconnected and will limit the output from the Zappi to prevent the grid supply being overloaded.

This setting applies to wired CT's and is found on the Advanced – CT Config menu

16. Advanced Settings

The Advanced Settings menu is passcode protected.

The default passcode is 0 0 0 0 although it can be changed with the Passcode menu option.

16.1 Supply Grid – Device Settings

Phase/Phase Rotation

| | |
|--------------------|---|
| Single Phase Zappi | The Phase setting is only used when installing a single phase Zappi onto a 3-phase supply. It should be set to match the phase number that the Zappi is wired to so that the power measurements are correct and that the Zappi responds to the correct phase when using the harvi wireless sensor. |
| Three Phase Zappi | The Phase Rotation setting is only used on three phase units and should correspond to the wiring to the input terminals. Only the following specific options are available: <ul style="list-style-type: none"> • 1/2/3 (Phase 1 wired into “L1”, Phase 2 wired into “L2”, Phase 3 wired into “L3”) • 2/3/1 (Phase 2 wired into “L1”, Phase 3 wired into “L2”, Phase 1 wired into “L3”) • 3/1/2 (Phase 3 wired into “L1”, Phase 1 wired into “L2”, Phase 2 wired into “L3”) |

Phase Return

Single Phase Zappi only

When a single phase Zappi is installed on a 230V delta connected supply, it is necessary to tell Zappi which phase has been connected to the neutral terminal.

Note: *In most installations the Phase Return setting should be left as “N” for Neutral*

16.2 Device Limit

Sets the maximum current that the Zappi will draw (including when boosting and FAST mode). This is useful if the supply current is limited, for instance, if Zappi is connected on a 16A circuit instead of a 32A.

16.3 Neutral Limit

In some countries the electricity distribution company limit the maximum current that can flow in the neutral conductor on a three phase supply (for example, the neutral current is limited to 20A in Germany). Use this setting if a neutral current limit is specified for your installation.

16.4 Earthing

Before starting a charge, Zappi carries out a check to make sure that the protective earth conductor is still connected. This check only works in a TN or TT connected electricity supply. If you are on an IT supply or find that the protective earth check is too sensitive then change this setting to “IT”.

17. Supply Grid – Network Settings

17.1 Grid Limit/Load Curtailment

Sets the limit that can be drawn from the grid connection (i.e. the maximum import current or the main fuse rating).

Example: A property may have a grid supply limit of 65A. Several appliances are on so the property is consuming 12kW (52A). The user wants to charge in FAST mode. Without the Grid Limit set, the total consumption would exceed the allowed import current and trip the supply or blow a fuse. However, with a Grid Limit setting of 60A, Zappi would temporarily limit the charging current to 8A (about 1.8kW) and the maximum allowed import current would not be exceeded.

Note: When using a *harvi* to measure the grid supply, the highest value for the Grid Limit setting is 65 Amps. The maximum current limit when using a hardwired CT is 100A

Note: For installation in the UK where the Distribution Network Operator accepts load curtailment instead of an upgrade to the supply, the Grid CT must be wired to the Zappi and cannot be used with a *harvi*.

17.2 Battery

If the property has a static AC battery system installed, it is possible to get the Zappi to work in harmony with the battery system, provided a CT has been installed to monitor the battery inverter.

The table below details the different settings for working with an AC coupled battery storage system:

| Setting | Function Description |
|---------------------|--|
| None | There is no battery system installed. |
| Avoid Drain | Stops the Zappi (or other linked myenergi devices) draining the battery when using surplus power from the solar or wind generation. |
| Avoid Charge | Effectively allows the Zappi (or other linked myenergi devices) to take priority over the battery when charging from solar or wind generation. |
| Avoid Both | Provides both of the above functions. This setting will normally provide the best compatibility |
| Limit to Gen | Will limit the output of the Zappi (except when boosting), to prevent unwanted draining of an AC coupled battery system. This setting does not require a CT to monitor the battery but does need a CT to monitor the solar/wind generation. Note: This setting is to support legacy installations – it is preferable to install a CT to monitor the battery and use one of the settings below. |

17.3 Net Phases

When enabled, all readings from 3-phase myenergi devices configured as 3-phase, will be netted. This means that surplus generation on ANY phase will be considered available for consumption on ANY other phase.

Note: With a three phase Zappi, Net Phases *should normally be turned on*

17.4 Export Margin

This sets a minimum level of export power which is maintained when Zappi is charging in ECO or ECO+ modes.

Export Margin would normally be set to 0W (zero Watts) so that all available surplus will be used to charge the vehicle. In some cases, it may be desirable to always set a minimum export level set. An instance of this would be when using Zappi with a hybrid PV/battery system.

17.5 CT Config

Zappi measures current by using a number of Current Transformers (CTs). It is important that these are set up correctly so Zappi knows the different power flows and can control the EV charge rate.

The 3 CT inputs should be configured to match the connected CT sensors. There are further settings for the internal CT which measures the current being drawn by the EV.

Note: If you have CTs connected to a hQrVi then these CTs also need to be set up correctly. For a hQrVi, the CT settings are found through the Linked Devices menu rather than the CT Config menu.

Important: There must be only one Grid CT set (per phase) for the whole installation.

| CT | Function Description |
|-------|---|
| CTINT | This is the internal CT which measures the output (charging) current of the zappi |
| CT1 | CT1 Input |
| CT2 | CT2 Input |
| CT3 | CT3 Input |

CT Types

| CT Type | Function Description |
|--------------------------|---|
| None | No CT connected. |
| Grid | Grid CT monitors the import and export power of the property. This is the CT used to determine if surplus power is available. There must only be one Grid CT set for each phase |
| Generation Only | Monitors Solar PV or Wind generation |
| Storage Only | Monitors a device that can 'store' energy (e.g. a third-party energy diverter) and enables the zappi to take priority over it. The power used by the third-party device is considered as surplus power unless the device is intentionally using grid power (i.e. it is boosting). The CT should be installed on the “live” supply cable feeding the diverter, with the arrow pointing away from it (i.e. towards the consumer unit / fuse board) |
| Gen & Battery | Monitors Solar PV or Wind generation that is combined with a DC-coupled battery |
| Monitor | Monitors any load, for example a washing machine or a lighting circuit. This setting can also be used to limit current drawn by myenergi devices on a particular circuit which includes other loads. |
| AC Battery | Used to monitor an AC-coupled battery. With this setting it is possible to manage the distribution of surplus energy between the battery and the zappi (and other myenergi devices). The Battery setting in the Supply Grid menu is used to configure how the zappi will operate alongside the battery system. The CT should be installed on the “live” supply cable of the battery inverter/charger, with the arrow pointing away from it (i.e. towards the consumer unit / fuse board). |

17.6 CT Detect Protection

When using a wired CT for the Grid current reading, Zappi can also monitor the CT to make sure that it is still connected. This is important when using the Grid Limit (or “Load Curtailment”) function in the Zappi and is a required by some distribution companies.

“G100” is a UK requirement which describes the technical requirements for export limiting schemes. It does not apply directly to “import limitation” or “load curtailment” schemes but the general requirements are referred to by UK Distribution Network Operators in this context.

Normally the CT Detect setting should be turned ON for wired Grid CTs

17.7 CT Groups

CTs can be put in groups so that their readings are netted (combined). For example, you might want to monitor two solar PV systems and see the total generation on the display. Use Group in the CT Config menu to set which group the CT should be in.

Note: Different CT Types cannot be in the same group, the group names make this clear.

Only the first 4 groups can be used for current limiting, see *Group Limits* below.

17.8 Group Limits

Current limits can be set for certain CT Groups. When a Group Limit is set the myENERGI devices in the group will limit the power they draw to keep within the set limit.

Group limits should be set only on the master device.

It is possible to use more than one group limit type (e.g. IL1 with MN1, so that there are two conditions for limiting). Some examples of how to set up the group limits are described in the table below.

| Group Limit Example | Additional CT Installed | CT Config (all devices) |
|---|--|---|
| Limit current drawn by two Zappi devices that are on the same 32A supply. | None; only the internal CTs are used. | CTINT Type: Internal Group: IL1 Group Limit: 32A |
| Limit current drawn by a Zappi device that is fed from a 32A supply which is also feeding another appliance (e.g. a tumble dryer). | One CT is clipped around Live of the 32A supply and wired to CT2 of the Zappi. | CT2 Type: Monitor Group: MN1 Group Limit: 32A |
| Limit current drawn by two Zappi devices that are in a garage which is fed from a 40A supply. A washing machine and dryer are also in the garage. | One CT is clipped around Live of the 40A supply to the garage and wired to CT2 of one of the Zappi units. Note: The other Zappi does not need to have a CT connected, but it will still need to have a CT input configured to be in the same Monitor group. | CT2 Type: Monitor Group: MN1 Group Limit: 40A |

18. Preconditioning

Most EV's provide a preconditioning function that can be used to prepare the vehicle for a journey – typically by warming/cooling the inside of the car, defrosting the windscreen and possibly warming the battery so that it is in the optimum state for driving the vehicle.

To avoid draining the battery to precondition the car, the Zappi preconditioning mode can be set so that the power needed is provided from the electricity supply.

Note: This feature only works if Zappi has detected “Charge Complete” i.e. the previous charge was stopped by the EV because the battery was full.

If this is not the case, then the only way to ensure that the battery is not drained during the EV preconditioning is to set a Scheduled Boost to coincide with time when the EV will be preconditioning.

18.1 Setting Preconditioning

The preconditioning mode can set to “On” or “Off”:

| CT Type | Function Description |
|---------|---|
| Off | Once zappi detects “Charge Complete”, the next time the EV tries to draw power zappi will revert to the mode set (ie ECO, ECO+ or FAST). If zappi is in ECO+ and there is not enough surplus generation then the charge will pause and zappi will display "Waiting for surplus" |
| On | When preconditioning is turned ON, the amount of energy (kWh) zappi should supply to warm up the battery / precondition the EV can also be set. Once zappi detects “Charge Complete”, the next time the EV tries to draw power zappi will start a Preconditioning Boost (to the kWh target set) and then revert to normal charging, in whatever mode it is set to. |

Note: Some vehicles (for example the Tesla Model S) need a lot of power to warm a cold battery even for standard charging. If you try to charge one of these vehicles in ECO and ECO+ mode the EV may charge for a short period, stop because it does not have enough power to warm the battery and then immediately try to charge the EV again.

We cannot guarantee that the Preconditioning Mode will cope with this situation but provided the EV draws a small amount of power the first time it tries to charge this should trigger the Preconditioning Mode, providing enough boost power to warm the EV's battery and allow normal ECO/ECO+ charging to proceed.

19. eSense

The eSense input can be used for two function:

1. It can be configured to automatically activate a Boost during ECO or ECO+ charging, whenever economy tariff electricity is available. The eSense input must be wired to a circuit which is live or an external volt free contact which closes during the economy tariff times for this to function.
2. It can be used to limit the Zappi output or stop the charge - for instance, using an external contact from a smart meter or control box provided by the Distribution Company who may require the ability to control the power being used to charge an EV if their network is overloaded

| eSense Setting | Description |
|---------------------------|--|
| Disabled | eSense input is ignored |
| Boost | If the eSense input is live, zappi will boost the charge |
| Boost Timer Enable | zappi will boost the charge if eSense is live AND the boost timer is set to operate at that time. |
| Load Limit | If the eSense input is live, zappi will limit the charge rate. The default limit is set to 7.2A but can be altered |
| Stop | If the eSense input is live, zappi will not charge, regardless of set charge mode or a boost |

20. myenergi app

The myenergi app allows you to control and monitor your myenergi devices, in real-time, from anywhere in the world.

20.1 Setting Priorities

If you have multiple myenergi devices you can control how energy is distributed to each of them in your app and it couldn't be simpler.

Using your finger, simply select the device you want to move and drag it to the priority position you want it to take.

The higher up towards the house icon, the higher the priority for surplus energy. The lower down and further away from the house icon the lesser the priority for surplus energy.

If you have a myenergi eddi and/or zappi, regardless of the settings you have selected, libbi can only provide energy to the zappi and/or eddi if they are above them in priority.

i.e. Anything below the house icon receives surplus energy in the order of priority, going downwards. Going upwards libbi will only provide energy to anything shown above it in priority.

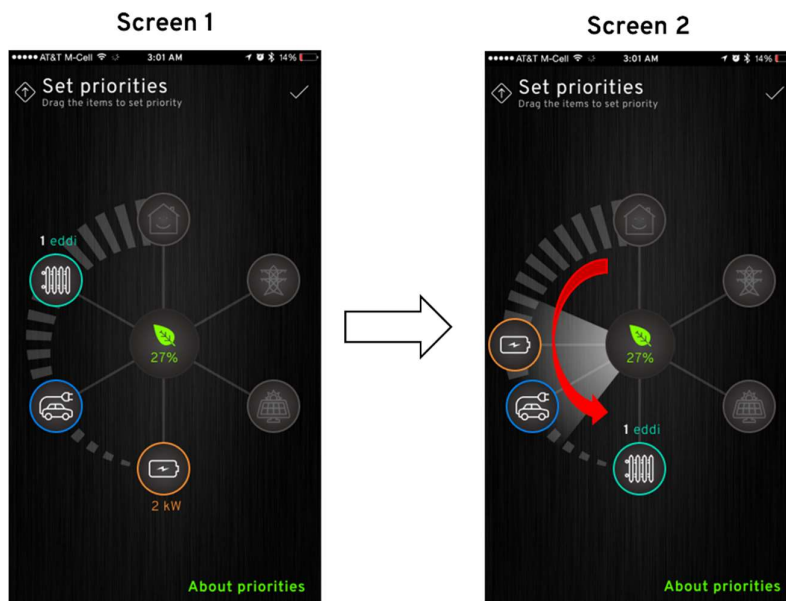

Screen 1, above, shows eddi as the highest priority and libbi as the lowest priority. So, eddi will receive any surplus energy first, followed by zappi and lastly followed by libbi. As libbi is below both zappi and eddi, libbi can supply energy to them both (depending on the settings you have selected for your zappi and eddi devices).

Screen 2, eddi has been dragged to the bottom which means eddi is now the lowest priority to receive surplus energy. libbi has been moved to the 'same' priority as zappi. Because they are the same priority they will both receive surplus energy equally but because libbi is above zappi, libbi cannot provide energy to zappi.

20.1.1 Priorities Explained

Example 1



For surplus generation energy, eddi is the highest priority, followed by the zappi, then followed by the libbi. This means eddi will receive any surplus energy first before it is offered to the zappi and lastly it will be given to the libbi, providing eddi and zappi aren't in requirement of it. libbi is below both zappi and eddi meaning it can provide energy to both devices (depending on the preference you've selected either in your myenergy app or on the eddi/zappi device itself)

Example 2



For surplus generation energy, eddi and libbi are of equal highest priority so they will receive any surplus energy equally first. Surplus energy will lastly be offered to zappi which is lowest priority. Although eddi and libbi are of equal priority, because the libbi is positioned below the eddi, libbi can provide energy to eddi. However, libbi cannot provide energy to zappi because zappi is positioned below libbi.

Example 3



For surplus generation energy, libbi and eddi are of equal highest priority so they will receive any surplus energy equally first. Surplus energy will lastly be offered to zappi which is lowest priority. Although libbi and eddi are of equal priority, because the eddi is positioned below the libbi, libbi cannot provide energy to eddi. libbi also cannot provide energy to zappi because zappi is positioned below libbi. However, libbi can still provide energy to the home.

Example 4



For surplus generation energy, libbi is the highest priority, followed by the eddi, then followed by the zappi. This means libbi will receive any surplus energy first before it is offered to the eddi and lastly it will be offered to the zappi, providing eddi and libbi aren't in requirement of it. libbi is above both zappi and eddi meaning it cannot provide energy to either device. However, libbi can still provide energy to the home.

Example 5



This myenergi eco-system consists of two libbis and an eddi. We will refer to the highest libbi as libbi 1 and the lowest libbi as libbi 2, for this example.

For surplus generation energy, libbi 1 is the highest priority, followed by the eddi, then followed by libbi 2. This means libbi 1 will receive any surplus energy first before it is offered to the eddi and lastly it will be given to the libbi 2, providing eddi and libbi 1 aren't in requirement of it. libbi 1 is above eddi meaning it cannot provide energy to it but it can still provide energy to the home. libbi 2 is positioned below eddi meaning libbi 2 can provide energy to eddi as well as to the home.







21. Troubleshooting

| Symptom | Cause | Solution |
|--|---|---|
| Display is blank | <ul style="list-style-type: none"> There is no power to the unit | <ul style="list-style-type: none"> Check for correct supply voltage at the supply screw terminals (220 - 260V AC) |
| In ECO+ mode, the charge does not start, the display is always showing Waiting for Surplus and the export power is 0W | <ul style="list-style-type: none"> Grid Sensor incorrectly installed Faulty Grid Sensor No signal from harvi (if used) | <ul style="list-style-type: none"> Check the grid sensor is connected to a CT terminal in the zappi or any CT input in the harvi Check the Grid CT sensor is installed on the correct cable Check resistance of the sensor - it should be around 200Ω when not connected (remove the sensor from the cable before testing resistance) If using harvi, check that the CT input has been set to Grid in the harvi settings (under Linked Devices / Devices in the zappi Advanced Settings menu) |
| In ECO+ mode, the charge does not start, the display is always showing Waiting for Surplus , yet the export power is showing correctly | <ul style="list-style-type: none"> Export Margin set too high | <ul style="list-style-type: none"> Check Export Margin setting (default is 0W) |
| Generation power is always 0kW | <ul style="list-style-type: none"> Generation CT not installed | <ul style="list-style-type: none"> Install generation sensor and connect to one of the CT inputs Alternatively, if there is no Generation CT, the Generation and House consumption figures can be hidden on the main screen by changing the Icons setting in the Settings / Display & Sound menu |
| Installation Limit ! displayed Display will show the phase(s) that is(are) overloaded and the prospective current that would be drawn if the zappi were allowed to start charge at the minimum current | <ul style="list-style-type: none"> The measured Grid Current is greater than the Grid Limit set in the zappi | <ul style="list-style-type: none"> Check the Grid Limit setting Reduce the load in the property In a three phase installation, consider rebalancing the property load across the three phases |
| Installation Limit ! CT displayed | <ul style="list-style-type: none"> The Grid CT has become disconnected or is not | <ul style="list-style-type: none"> Check CT is installed correctly. |

clamped correctly
around the grid supply
cable

22. Fault Codes

If any of the following fault messages are displayed, follow the action described.

| Displayed Message | Description | Action |
|--|--|---|
| Unknown Cable ! | zappi has detected an unknown EV cable (untethered units only) Make sure you are using genuine IEC 62196-2 compliant plugs. Range supported: 32A, 20A and 13A. | zappi will automatically retest the cable after 5 seconds. If the issue persists, unplug the cable check for dirt in the plug and try again. |
| Pilot problem ! | zappi has detected an issue with the “Control Pilot” signal on the cable between the zappi and the EV. | zappi will automatically retest the cable after 5 seconds. If the issue persists unplug the cable, check for dirt in the plug and try again. |
| Lock Failure ! Fault code 23 | The socket lock actuator couldn't lock/unlock the inserted plug as expected (untethered units only). | This message can happen when the plug is not fully inserted or if it is twisted or pulled from the socket. Push the plug fully into the zappi to release the plug, then press and hold the  button to reset the unit. |
| Output Fault ! Fault code 24 | zappi has detected a wrong output voltage. e.g. a voltage has been detected when it should be off. | Unplug the EV, press and hold the  button to reset the unit. |
| PE Fault ! Fault code 25 | zappi has detected a problem with the main earth connection to the unit. The earth is either disconnected or the impedance of the earth connection is too high. | Unplug the EV, check the earth connection to the zappi and then hold the  button to reset the unit. If the electricity supply is “IT earthed” check the Supply Grid / Earthing menu setting. |
| Comms Fault ! Fault code 26 | zappi has detected an issue with the built-in protection components. | Unplug the EV, press and hold the  button to reset the unit. |
| SelfTest Failed ! Fault code 27 | The built-in protection devices couldn't be tested or failed the test prior to a charge. | Unplug the EV, press and hold the  button to reset the unit. |
| Contactor Fault ! Fault code 28 | The relay inside the zappi has a welded contact. The secondary relay is open to make sure that the supply to the EV is isolated. | Unplug the EV, press and hold the  button to reset the unit. |

| | | |
|---|--|---|
| PEN Fault! Fault code 29 | The internal protection against the loss of the PEN conductor on the electricity supply has tripped. | Unplug the EV, make sure that the fault has been removed then press and hold the Ⓜ button to reset the unit. |
| Overload ! Fault code 30 | The EV is drawing too much current – the output is switched off. | Unplug the EV, press and hold the Ⓜ button to reset the unit. |
| Bad Voltage Range ! Over Voltage! Under Voltage! Fault code 31 | zappi has detected that the supply voltage is too high/low and has disconnected the EV to protect it. | Unplug the EV, make sure that the fault has been removed and hold the Ⓜ button to reset the unit. |
| Overheating! | The zappi unit is too hot – the output is switched off. | Make sure that the zappi is properly ventilated (e.g. has not been covered). Charge will resume once the unit has cooled down again. |
| Voltage Mismatch ! Fault code 32 | The output voltage detected by zappi and the built-in protection components is not the same. | Unplug the EV, press and hold the Ⓜ button to reset the unit |
| Charge Blocked ! | zappi has detected that the EV has repeatedly tried to start a charge even though the EV has previously reached “Charge Complete” i.e. The battery is full, the battery has reached a charge level set in the EV, or the charge has been stopped by a timer in the EV. | Unplug the EV Charging will continue when the EV is plugged in again |

If any of the above faults persist then stop using zappi and contact your supplier or myenergi Technical Support.

23. Warranty

Full details of the myenergi product warranty are available on our web site or by using this QR code.



24. Technical Specifications

24.1 Performance

| | |
|------------------------|--|
| Mounting Location | Indoor or Outdoor (permanent mounting) |
| Charging Mode | Mode 3 (IEC 61851-1 compliant communication protocol) |
| Display | Graphical backlit LCD |
| Front LED | Multicolour, according to charge status, current and user setting |
| Charging Current | 6A to 32A (variable) |
| Dynamic Load Balancing | Optional setting to limit current drawn from the unit supply or the grid |
| Charging Profile | 3 charging modes: ECO, ECO+ or FAST. STOP is a further option |
| Connector Type | Type 2 tethered cable (6.5m) or type 2 socket with locking system |
| Compliance | LVD 2014/35/EU, EMC 2014/30/EU, EN 62196-2:2017, ROHS 2011/65/EU, CE Certified, EN 61851-1:2019* |

* *Zappi* complies fully with EN 61851-1:2019 with the exception of Clause 8.4 in order to meet the requirements of BS 7671:2018 Amendment 1:2020 which requires the protective earth conductor to be switched in order to provide protection against a damaged PEN conductor in a TN-C-S earthed electrical system.

24.2 Electrical Specifications

| | |
|----------------------------|---|
| Rated Power | 7kW (1-phase) or 22kW (3-phase) |
| Rated Supply Voltage | 230V AC Single Phase or 400V AC 3-Phase (+/- 10%) |
| Supply Frequency | 50Hz |
| Rated Current | 32A max |
| Standby Power Consumption | 3W |
| Economy Tariff Sense Input | 230V AC sensing (4.0kV isolated) |
| Wireless Interface | 868 MHz / 915 MHz (-A units) proprietary protocol for wireless sensor and remote monitoring options |
| Grid Current Sensor | 100A max. primary current, 16mm max. cable diameter |
| Supply Cable Entry | Rear / Bottom / Left side / Right side |

24.3 Mechanical Specifications

| | | |
|-----------------------|---|-------------------------------|
| Enclosure Dimensions | 439 x 282 x 122mm | |
| Protection Degree | IP65 (weatherproof) | |
| Enclosure Material | ASA 6 & 3mm (UL 94 flame retardant) colours: white RAL 9016 and grey RAL 9006 | |
| Operating Temperature | -25°C to +40°C | |
| Fixing Points | In-line vertical mounting holes | |
| Weight | Single Phase Untethered: 3.0kg | Three Phase Untethered: 3.3kg |
| | Single Phase Tethered: 5.5kg | Three Phase Tethered: 7.2kg |

24.4 Connectivity

WiFi 2.4 GHz 802.11BGN Connection up to 150 Mbps

WiFi Frequency Range 2412-2484 MHz

Radio Frequency Range 868-870MHz

Radio Frequency (Australia) 915MHz

24.5 Max Transmitted Power

| | |
|-------|-------|
| Radio | 25mW |
| WiFi | 100mW |

25. Model Variants

| Model No. | Rating | Connector | Colour |
|----------------|----------------|------------|--------|
| ZAPPI-2H07UW-G | 7kW | Untethered | White |
| ZAPPI-2H07TW-G | 7kW | Tethered | White |
| ZAPPI-2H07UB-G | 7kW | Untethered | Black |
| ZAPPI-2H07TB-G | 7kW | Tethered | Black |
| ZAPPI-2H22UW-G | 22kW (3-Phase) | Untethered | White |
| ZAPPI-2H22TW-G | 22kW (3-Phase) | Tethered | White |
| ZAPPI-2H22UB-G | 22kW (3-Phase) | Untethered | Black |
| ZAPPI-2H22TB-G | 22kW (3-Phase) | Tethered | Black |

Designed to permit installations compliant with IET Wiring Regulations BS 7671:2018 Amendment 1:2020 and the Electricity Safety, Quality, and Continuity Regulations 2002 and BS 8300:2009+A1:2010.

26. Technical Support

If you experience any issues with your zappi post installation, please contact our Technical Support Team by scanning the QR Code below.



Please contact us directly for the quickest solution.

Appendix A

Electric Vehicle (Smart Charge Points) Regulations 2021

As of 30th June 2022

Relevant to zappi INSTALLED from 30th June 2022

1. Electric Vehicles (Smart Charge Points) Regulations 2021

From 30th June 2022, any EV charger installed in a private setting i.e. home or workplace NOT public, in England, Scotland and Wales has to meet the Electric Vehicles (Smart Charge Points) Regulations 2021.

1.1 Purpose of the Regulations

The new smart charging regulations are a huge, positive forward-step by the UK Government in preparing our homes and businesses for a smart, connected and democratized energy system. Essential tools in driving down emissions and a core reason why myenergi exists.

The regulations are focused around when you are charging an EV. The aim of the regulations is to prevent everyone charging at the same time and putting too much demand on the grid.

1.2 What's changed with zappi

New features have been added to zappi to ensure our products remain compliant with UK Regulations.

These include:

- **Randomised Delay** – At the start of a charge and end of a scheduled, Timed Boost there will be a delay of up to 10 minutes before your vehicle starts and stops charging. This could be a few seconds or it could be up to the full 10 minutes. This is necessary to ensure everyone does not overload the grid by starting to charge or ending a charge at the same time. The Randomised Delay can be overridden, if necessary.
- **Smart Scheduling** – To comply with the smart charging regulations your zappi will be set to charge in off-peak hours by default. This is between 00:00 – 08:00. You may change this schedule at any time if you would prefer to charge in peak hours or your electricity tariff off-peak hours differ from those set.
- **Default to ECO+ mode** – If Smart Regulations apply, zappi will default to ECO+ mode on first boot up.
- **Charging logs** – You will now be able to view a record of charging logs from the past 13 months. See Charge Logs section below for further information.

1.3 Randomised Delay: How it works

As mentioned above, Randomised Delay will put a completely random delay at the start of a charge and end of a scheduled, Timed Boost, for up to 10 minutes. This can be overridden by the customer in situations where they are in a hurry.

1.3.1 Delay Status

You will be able to see if your charger is in a state of delay at any time as it will be displayed on both the zappi screen and in the myenergi app.

1.3.2 Overriding the delay

To override the delay simply press the '+' button on the zappi or press the 'charge now' button displayed in the pop-up message within the myenergi app. If the delay is overridden your charge will start/stop immediately.



You cannot permanently override the delay function. If you wish to override the delay each time you charge, you will need to follow the above instruction to override on every applicable charging session.

1.4 Smart Scheduling: How it works

As summarised under section 1.2 your zappi will be set to charge in off-peak hours by default from initial start-up.

1.4.1 Off-peak hours

Off-peak hours are usually between 00:00 – 08:00, depending on your specific tariff, this is when your electricity will be at it's cheapest.

1.4.2 Reason for Smart Scheduling

Encouraging you to charge in off-peak hours prevents overloading the grid in peak times.

1.4.3 Benefits of Smart Scheduling

Smart Scheduling will can help you spend less on your electricity. By charging in off-peak hours your electricity tariff may be cheaper.

1.4.4 Changing the set schedule

If the default schedule does not suit your requirements, or your electricity tariff's off-peak hours differ from the schedule set, you can amend your schedule at any time from the zappi menu or within the myenergi app.

To adjust your schedule in the app navigate to the 'Set Boost Parameters' option, select start time and set the number of hours you want your charger to boost for.

To change the schedule on your zappi device navigate to 'Charge Settings > Boost Timer' and amend the schedule as desired. *For further information see the Timed Boost section of the User Manual.*

Alternatively, the schedule may be deleted altogether, if required. To do this ensure all inputs are set to 00:00 for each day of the week.

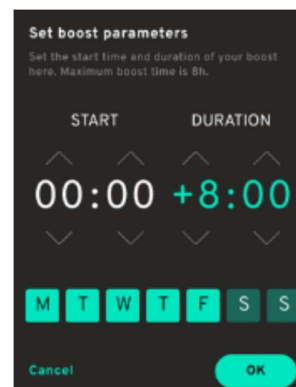

1.5 Defaulting to 'ECO+' Mode

As mentioned in section 1.2 if your zappi meets the Smart Regulation parameters it will default to ECO+ mode upon first start-up. This can be changed to ECO+ or FAST mode at any time by the customer. *See Charging Modes section of the User Manual for further information on modes.*

1.5.1 Manual Boost

If you choose to remain in ECO+ mode you can still charge from the grid at any time by doing a Manual Boost. Refer to Manual Boost section of the User Manual for further information on this existing feature.

1.6 Charging Logs

Providing your zappi is internet connected and you have registered your device in myaccount you will be able to view a record of charge logs for the last 13 month period. This function will begin from 30th June 2022 so the earliest time you will see the whole 13 months will be from July 2023 or 13 months from when your device was connected to the internet. The charge logs will tell you when the charge started, when the session ended and the duration of each session.

To view your logs log into your account at <https://myaccount.myenergi.com/login>

Navigate to “My Energi Usage” in the left hand menu. The charge logs will be displayed like to example below.

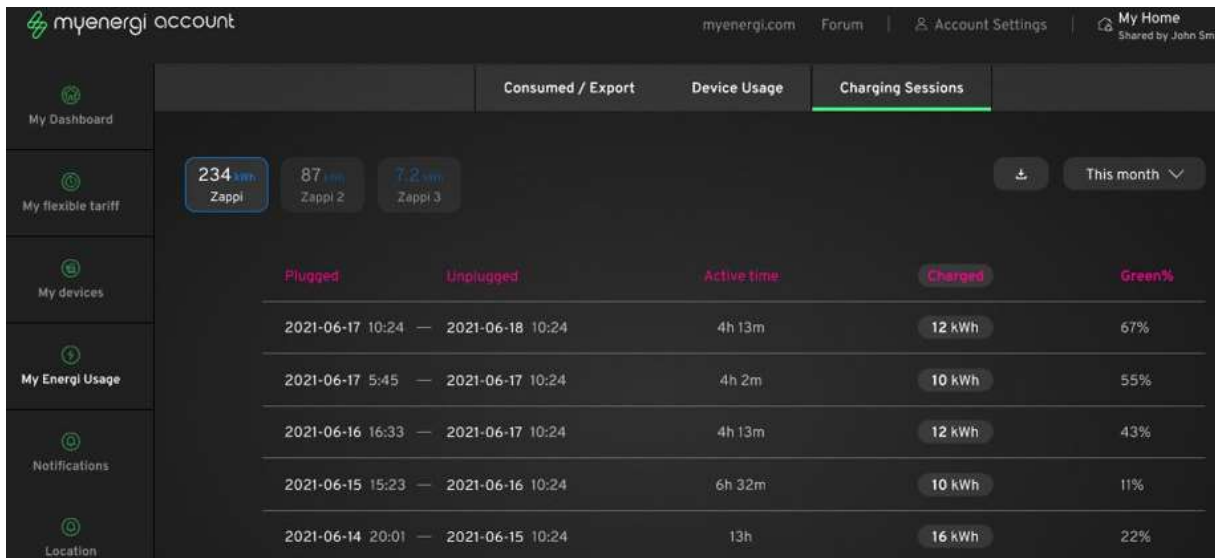

| Plugged | Unplugged | Active time | Charged | Green% |
|-------------------------------------|-----------|-------------|---------|--------|
| 2021-06-17 10:24 — 2021-06-18 10:24 | | 4h 13m | 12 kWh | 67% |
| 2021-06-17 5:45 — 2021-06-17 10:24 | | 4h 2m | 10 kWh | 55% |
| 2021-06-16 16:33 — 2021-06-17 10:24 | | 4h 13m | 12 kWh | 43% |
| 2021-06-15 15:23 — 2021-06-16 10:24 | | 6h 32m | 10 kWh | 11% |
| 2021-06-14 20:01 — 2021-06-15 10:24 | | 13h | 16 kWh | 22% |

Appendix B

Electric Vehicle (Smart Charge Points) Regulations 2021

As of 30th December 2022

Applies to all zappis Installed on or after 30th December 2022

2. Electric Vehicles (Smart Charge Points) Regulations 2021

In addition to the regulations explained in Appendix A, from 30th December 2022, any EV charger installed in a private setting i.e. home or workplace NOT public, in England, Scotland and Wales has to meet FURTHER conditions to the Electric Vehicles (Smart Charge Points) Regulations 2021.

2.1 Purpose of the Regulations

Every day cyber criminals make attempts to target individuals and organisations. With a cyber attack attempted every 39 seconds these regulations have been put in place to mitigate the risk of this and ensure your device and information is secure from increasingly sophisticated attacks.

2.2 What's changed with zappi

The following features have been added to all zappis to comply with the Electric Vehicles (Smart Charge Points) Regulations 2021, Schedule 1, from 30th December 2022:

Set-up Wizard – The set-up wizard at power up has been changed to ensure smoother initial set-up. This includes internet connection and firmware updates upon start up.

Automatic Firmware Checking – zappi will regularly check for new software and will automatically display a message on your zappi screen to let you know in the myenergi app when updates are available.

Tamper Detection – We have added built-in tamper detection to alert you if anyone has removed the front cover of your zappi. You will be alerted in the myenergi app when tamper activity is detected.

Encryption – To protect your data from eavesdroppers zappi uses Advanced Encryption Standard (AES) to securely communicate throughout your home and across the internet.

2.3 Automatic Firmware Checking

Being on the latest firmware is one crucial way to prevent security breaches. To ensure you are always on the most up-to-date firmware, your zappi will regularly check for new software and you will be notified in your myenergi app when updates are available.

You then have the option to select “Install now” or “later”.

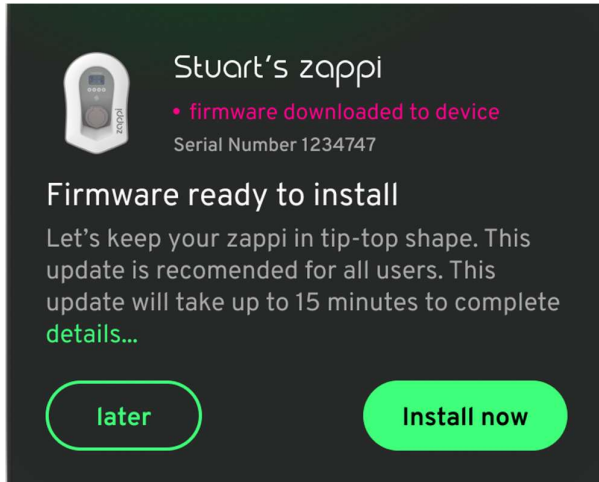

NOTICE

Firmware updates can only be delayed up to 3 times.

2.4 Tamper Detection

A tamper detection feature has been added to our zappi devices. This ensures that any time the cover is removed from your zappi you will be alerted that it has been tampered with.

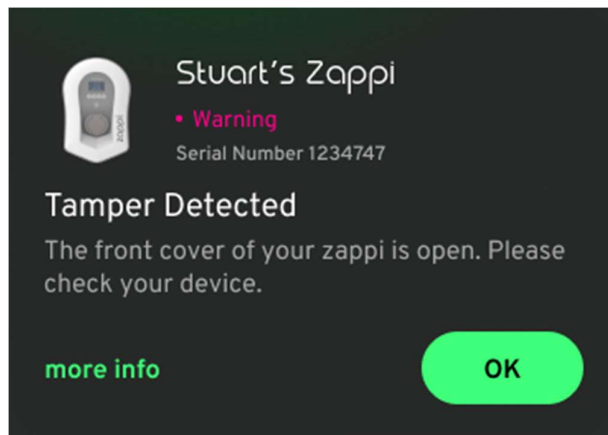

2.5 AES Encryption

To protect your data from eavesdroppers zappi uses Advanced Encryption Standard (AES) to securely communicate throughout your home and across the internet.

Linked devices will communicate via AES and communication between your devices and the internet will also be via AES.

For customers with older myenergi devices that don't have the compatibility to communicate in encryption there is a new device menu setting which allows you to turn off encryption. If encryption is turned off this will only turn off encrypted communication locally between devices. Communication externally across the internet will still use encryption.

2.6 Installer Requirements

It is the responsibility of the installer to ensure they are compliant with Electric Vehicles (Smart Charge Points) Regulations 2021. This includes, but is not limited to:

- Installing only compliant charge points in private installs from and including 30th December 2022.
- Answering the start-up wizard questions accurately to reflect actual install parameters.
- Having a Technical File and/or Declaration of Compliance available if requested by the customer (myenergi's Technical File and Declaration of Compliance is available at: <https://myenergi.com/guides/smart-charge-point-regulations-explained/>)

The installer should ensure they are fully aware of and understand how the regulations affect them and what they are required to do to ensure they comply. These regulations should be monitored for any future updates. For further information or to view the current Electric Vehicles (Smart Charge Points) Regulations 2021 visit:

<https://www.legislation.gov.uk/ukdsi/2021/9780348228434>

or

<https://www.gov.uk/guidance/regulations-electric-vehicle-smart-charge-points>

Further information can also be found by following the QR code below which will take you to myenergi's Smart Regulations webpage which contains reference documents, FAQs and simplified explanations of the regulations.



<https://myenergi.com/guides/smart-charge-point-regulations-explained/>



myenergi

Designed and manufactured in the UK by
myenergi Ltd, Pioneer Business Park, Faraday Way,
Stallingborough, Grimsby, DN41 8FF

T: +44 (0)333 300 1303

E: sales@myenergi.com

W: myenergi.com