

Product datasheet

Specifications



Single contact block, silver alloy, screw clamp terminal, 1 NC

Local distributor code: 237121752 ZBE102

EAN Code : 3389110089486

Main

Range of product	Harmony XB4 Harmony XB5
Product or component type	Contact block
Device short name	ZBE
Sale per indivisible quantity	5
IP degree of protection	IP20 conforming to IEC 60529
Contact operation	Slow-break
Contact block type	Single
Contacts usage	Standard contacts
Connections - terminals	Screw clamp terminals, $\leq 2 \times 1.5 \text{ mm}^2$ with cable end conforming to EN 60947-1 Screw clamp terminals, $\geq 1 \times 0.22 \text{ mm}^2$ without cable end conforming to EN 60947-1

Complementary

Net weight	0.011 kg
Contacts type and composition	1 NC
Positive opening	With conforming to EN/IEC 60947-5-1 appendix K
Operating travel	1.5 mm (NC changing electrical state) 4.3 mm (total travel)
Operating force	2 N NC changing electrical state
Mechanical durability	10000000 cycles
Tightening torque	0.8...1.2 N.m conforming to EN 60947-1
Shape of screw head	Cross compatible with pozidriv No 1 screwdriver Slotted compatible with flat $\varnothing 4 \text{ mm}$ screwdriver Slotted compatible with flat $\varnothing 5.5 \text{ mm}$ screwdriver
Contacts material	Silver alloy (Ag/Ni)
Short-circuit protection	10 A cartridge fuse type gG conforming to EN/IEC 60947-5-1
[Ith] conventional free air thermal current	10 A conforming to EN/IEC 60947-5-1
[Ui] rated insulation voltage	600 V (pollution degree 3) conforming to EN 60947-1
[Uimp] rated impulse withstand voltage	6 kV conforming to EN 60947-1
[Ie] rated operational current	3 A at 240 V, AC-15, A600 conforming to EN/IEC 60947-5-1 6 A at 120 V, AC-15, A600 conforming to EN/IEC 60947-5-1 0.1 A at 600 V, DC-13, Q600 conforming to EN/IEC 60947-5-1 0.27 A at 250 V, DC-13, Q600 conforming to EN/IEC 60947-5-1

Electrical durability	1000000 cycles, AC-15, 2 A at 230 V, operating rate <3600 cyc/h, load factor: 0.5 conforming to EN/IEC 60947-5-1 appendix C 1000000 cycles, AC-15, 3 A at 120 V, operating rate <3600 cyc/h, load factor: 0.5 conforming to EN/IEC 60947-5-1 appendix C 1000000 cycles, AC-15, 4 A at 24 V, operating rate <3600 cyc/h, load factor: 0.5 conforming to EN/IEC 60947-5-1 appendix C 1000000 cycles, DC-13, 0.2 A at 110 V, operating rate <3600 cyc/h, load factor: 0.5 conforming to EN/IEC 60947-5-1 appendix C 1000000 cycles, DC-13, 0.5 A at 24 V, operating rate <3600 cyc/h, load factor: 0.5 conforming to EN/IEC 60947-5-1 appendix C
------------------------------	---

Mounting of block	Front mounting
--------------------------	----------------

Electrical composition code	C1 (quantity <= 9) C2 (quantity <= 7) C3 (quantity <= 6) C4 (quantity <= 4) C5 (quantity <= 5) C6 (quantity <= 3) C7 (quantity <= 4) C8 (quantity <= 2) C9 (quantity <= 3) C12 (quantity <= 6) M1 (quantity <= 6) M2 (quantity <= 4) M3 (quantity <= 4) M5 (quantity <= 2) M6 (quantity <= 2) M7 (quantity <= 6) M8 (quantity <= 4) M9 (quantity <= 2) SF1 (quantity <= 3) SF2 (quantity <= 2) MF1 (quantity <= 2) MF2 (quantity <= 2) C10 (quantity <= 2) M4 (quantity <= 2) C13 (quantity <= 1)
------------------------------------	---

Device presentation	Basic element
----------------------------	---------------

Environment

Protective treatment	TH
-----------------------------	----

Ambient air temperature for storage	-40...70 °C
--	-------------

Ambient air temperature for operation	-40...70 °C
--	-------------

Standards	EN/IEC 60947-5-1 CSA C22.2 No 14 JIS C8201-5-1 EN/IEC 60947-1 UL 508 EN/IEC 60947-5-4 JIS C8201-1
------------------	---

Product certifications	CSA GOST BV DNV GL LROS (Lloyds register of shipping) CCC UL
-------------------------------	---

Vibration resistance	5 gn (f= 2...500 Hz) conforming to IEC 60068-2-6
-----------------------------	--

Shock resistance	30 gn (duration = 18 ms) for half sine wave acceleration conforming to IEC 60068-2-27 50 gn (duration = 11 ms) for half sine wave acceleration conforming to IEC 60068-2-27
-------------------------	--

Packing Units

Unit Type of Package 1	PCE
-------------------------------	-----

Number of Units in Package 1	1
-------------------------------------	---

Package 1 Height	5.500 cm
-------------------------	----------

Package 1 Width	3.400 cm
------------------------	----------

Package 1 Length	5.400 cm
-------------------------	----------

Package 1 Weight	9.000 g
Unit Type of Package 2	BB1
Number of Units in Package 2	5
Package 2 Height	5.600 cm
Package 2 Width	4.300 cm
Package 2 Length	5.400 cm
Package 2 Weight	52.000 g
Unit Type of Package 3	S03
Number of Units in Package 3	800
Package 3 Height	30.000 cm
Package 3 Width	30.000 cm
Package 3 Length	40.000 cm
Package 3 Weight	8.757 kg

Offer Sustainability

Sustainable offer status	Green Premium product
REACH Regulation	REACH Declaration
REACH free of SVHC	Yes
EU RoHS Directive	Pro-active compliance (Product out of EU RoHS legal scope) EU RoHS Declaration
Toxic heavy metal free	Yes
Mercury free	Yes
China RoHS Regulation	China RoHS declaration
RoHS exemption information	Yes
Environmental Disclosure	Product Environmental Profile
Circularity Profile	End of Life Information
WEEE	The product must be disposed on European Union markets following specific waste collection and never end up in rubbish bins

Contractual warranty

Warranty	18 months
----------	-----------

Dimensions

with ZB5AZ009 Fixing Collar

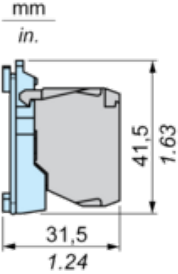

with ZB4BZ009 Fixing Collar

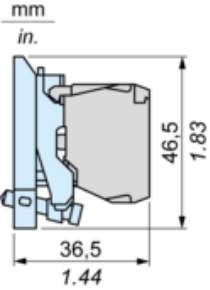

Dimensions

mm
in.

+ ZB5AZ009

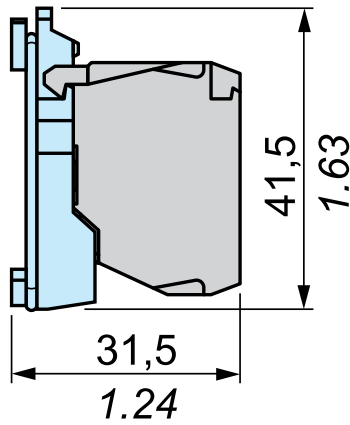

+ ZB4BZ009

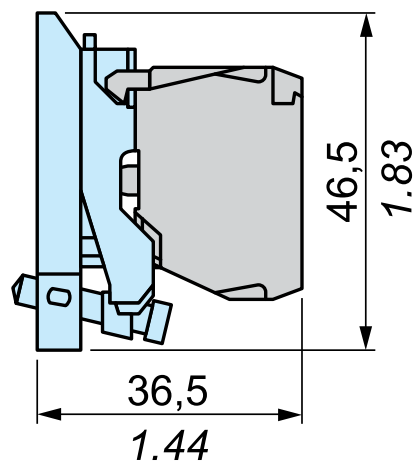

Recommended replacement(s)