





**"Waterproof", for encapsulating**



**WP 0202 G**

- 0.75-2.5 mm<sup>2</sup>, Cu 3~



- with terminals
- 5-pole per pole 8 x 0,75-1 mm<sup>2</sup> r / f, 6 x 1,5 mm<sup>2</sup> r / f, 4 x 2,5 mm<sup>2</sup> r / f, 2 x 4 mm<sup>2</sup> r / f
- cable entries via knockouts, order AKM separately (see cable entry systems LES)
- cable junction box for encapsulating
- for ground installation without live loads or in risk of condensation formation and ingress of liquids
- usable for heating cable / heating tape up to max. 70 °C surface temperature
- with sealing compound and sealing plug
- In case of re-installation or testing the sealing compound can be removed easily
- durability of sealing compound to processing ≥ 12 months at a storage temperature of 5 - 50 °C
- external brackets for wall fixing included
- colour: grey, RAL 7035

degree of protection	IP 68 submersion up to 20 meter, 168 hours
rated insulation voltage	U <sub>i</sub> = 690 V a.c./d.c.
rated current:	20 A
material	PC-GFS (polycarbonate)
width	93 mm
height	93 mm
depth	62 mm
weight	0,597 kg
tightening torque for terminal	0.5 Nm
in accordance with	EN 60670-1 DIN VDE V 0606-22-100

**Drawings**

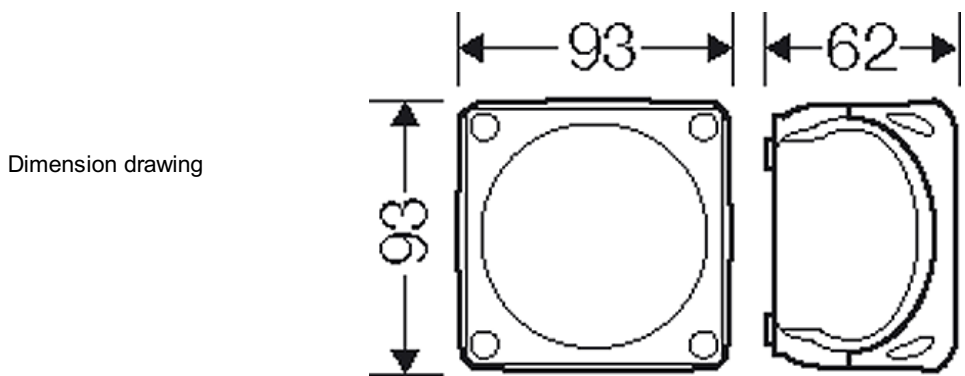

"Waterproof", for encapsulating

**WP 0202 G**

- 0.75-2.5 mm<sup>2</sup>, Cu 3~

IP  
66

IP  
68

Detail mass

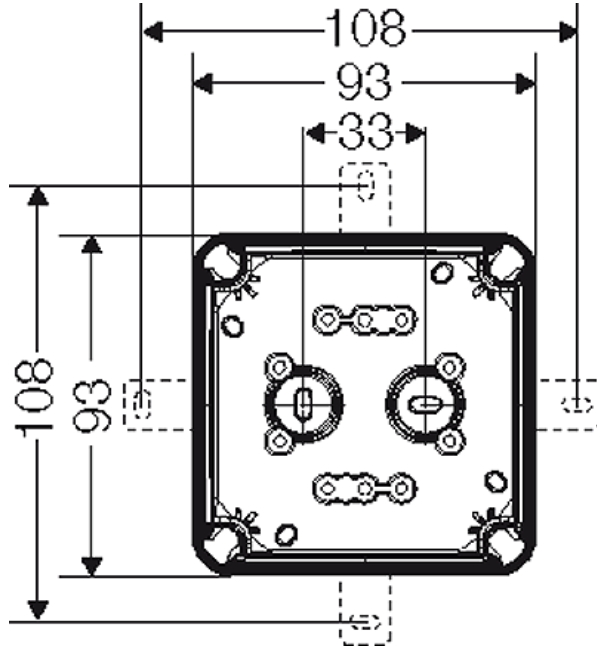



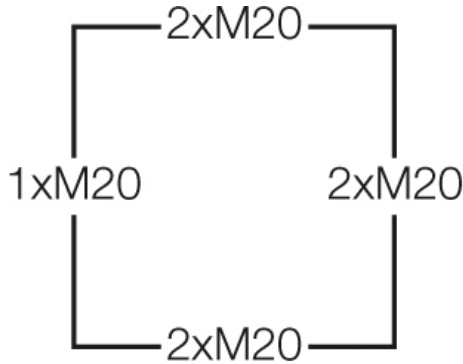

Box walls



**Operating and ambient conditions**

Application area	Suitable for outdoor installation (harsh environment and/or outdoor). For application in ambient conditions with formation of condensation and ingress of water as well as for installation in the ground without traffic loads in accordance with DIN VDE V 0606-22-100. Submersion up to 20 meter, 168 hours, IP 68.
Resistant to occasional cleaning procedures (direct jet)	Resistant to occasional cleaning procedures (direct jet) with high-pressure cleaner without additives, water temperature: max. 80° C
Ambient temperature	Average value over 24 hours + 55 °C Maximum value + 70 °C Minimum value - 25 °C
Relative humidity	100 %
Burning behaviour	Glow wire test IEC 60695-2-11: 960 °C UL Subject 94: V-0 flame-retardant self-extinguishing
Degree of protection against mechanical load	IK09 (10 Joule)

"Waterproof", for encapsulating

	<p><b>WP 0202 G</b></p> <ul style="list-style-type: none"><li>• 0.75-2.5 mm<sup>2</sup>, Cu 3~</li></ul>			
				

Toxic behaviour

halogen-free  
silicone-free  
isocyanate-free