

# CertaUPS

C300R USER MANUAL  
A COMPLETE INSTALLATION  
AND USER GUIDE

## THE C300R SERIES

An uninterruptible power supply (UPS) incorporating line interactive technology, which eliminates all mains power disturbances.

[www.certaups.com](http://www.certaups.com)

For assistance please contact your local CertaUPS partner.

## Contents

SAFETY INFORMATION.....	6
USER MANUAL SYMBOLS.....	6
HANDLING.....	6
OPERATING SAFETY.....	7
PRODUCT OVERVIEW.....	8
THE MODEL LIST.....	8
THE TECHNOLOGY.....	8
SUITABLE APPLICATIONS.....	9
ACCESSORIES.....	9
UPS STANDARDS.....	9
UPS INSTALLATION.....	10
INSPECTION.....	10
UNPACKING.....	10
C300R PACKAGING.....	10
UPS INSTALLATION.....	11
C300R TOWER INSTALLATION.....	11
C300R RACKMOUNT INSTALLATION.....	13
C300R SERIES STARTUP AND SHUTDOWN.....	15
STARTING THE UPS WITH MAIN POWER PRESENT.....	15
STARTING THE UPS FROM BATTERY.....	15
UPS SHUTDOWN WITH MAINS POWER.....	15
UPS SHUTDOWN WITHOUT MAINS POWER.....	16
C300R SERIES OPERATION.....	16
LCD DESCRIPTION.....	17
SETTINGS MENU.....	18
COMMUNICATION PORTS.....	19
RS232/USB.....	19
EPO CONNECTION.....	19
INTERFACE CARDS (OPTIONAL).....	19
SOFTWARE.....	20
UPS MAINTENACE.....	21
UPS CARE.....	21
TRANSPORTING THE UPS.....	21
STORING THE UPS.....	21

BATTERY REPLACEMENT .....	22
REPLACING THE EBM .....	22
RECYCLING A UPS.....	23
TROUBLESHOOTING.....	24
ALARMS & FAULTS .....	24
SILENCING THE ALARM .....	25
TESTING THE BATTERIES .....	25
TECHNICAL DATA .....	26
BLOCK DIAGRAM.....	26
ELECTRICAL SPECIFICATION .....	26
OPERATING ENVIROMENT .....	26
RUNTIMES .....	27
DIMENSIONS AND WEIGHTS.....	27









## SAFETY INFORMATION

### KEEP THESE INSTRUCTIONS IN A SAFE PLACE

This section contains essential information and instructions that should be followed to ensure the safe handling, installation and maintenance of CertaUPS equipment and batteries.

## USER MANUAL SYMBOLS

The following will be referenced throughout this document.

SYMBOL	DEFINITION
	Caution! Follow instructions carefully
	High Voltages, <b>RISK OF ELECTRICAL SHOCK</b>
	Power On/Off
	Alternating current (AC)
	Direct Current (DC)
	Grounding
	Recycle
	Not to be disposed of in general waste Waste electrical equipment or electronic equipment (WEEE) should not be disposed of in the general waste. CertaUPS systems should always be disposed of at a proper recycling/hazardous waste disposal centre. Please see page 10 for disposal guidance.

## HANDLING

### UPS handling weight guidelines

<18kg (<40lb)	One-person
18 – 32 kg (40 – 70 lb)	Two-person
32 – 55 kg (70 – 120 lb)	Three-person
>55 kg (>120 lb)	Forklift

### AUTHORISED PERSONNEL TO HANDLE ONLY

UPS systems contain high voltages when disconnected from the mains outlet and should only be serviced by qualified persons.

Before any handling please ensure that the following precautions are taken:

<b>QUALIFIED PERSONNEL</b> Any persons servicing the UPS must be qualified and knowledgeable in UPS technology and batteries	
<b>CLOTHING</b> Rubber gloves and safety boots to be worn	
<b>POWER OFF</b> Ensure all mains power is disconnected before starting work	
<b>TOOLS</b> always use insulated tools. Do not lay tools down near the Ups or batteries. Inadvertent grounding may cause a risk of electric shock	
<b>UPS GROUNDING</b> The UPS must always be properly grounded	

## CAUTIONARY NOTES

Please be aware of the following risks when handling and operating CertaUPS units.

RISK TYPE	DETAILS
Electric shock	Even after the unit is disconnected from the mains power supply (building outlet socket), components inside the UPS are still energised from the battery which are potentially dangerous
	The battery circuit is not isolated from the input voltage. Hazardous voltages may occur between the battery terminals and the ground. Verify that no voltage is present before servicing.
Hazardous voltages	Repairs must be carried out only by qualified UPS Engineer.

FOR FURTHER INFORMATION ON REPLACEMENT PARTS AND SERVICING PLEASE CONTACT YOUR CertaUPS PARTNER.

## OPERATING SAFETY

Before operating any UPS system, please read the following guidance:

<b>DO NOT</b> Install the UPS in a humid environment or expose to liquids	
<b>DO NOT</b> Block the ventilation of the UPS	
<b>DO NOT</b> Expose the UPS to direct sunlight or source of heat	
<b>DO NOT</b> Exceed ambient temperatures when operating or storing the UPS	
<b>DO NOT</b> Allow excessive particulates or foreign bodies enter the UPS	
<b>DO</b> Follow all connection procedures and operational instructions in the order in which they appear within this manual	
<b>DO</b> Check that the indicators on the rating plate correspond to the AC powered system and to the actual electrical consumption of all the equipment to be connected to the UPS	
<b>DO</b> Ensure the socket-outlet is installed near the PLUGGABLE equipment and is easily accessible	
<b>DO</b> Store the UPS in a dry environment	

Additional considerations:

- To reduce the risk of fire, the unit should only be connected to a circuit provided overcurrent protection by means or an MCB or other protective devices.
- The upstream circuit breaker/Isolator for Normal AC/Bypass AC must be easily accessible. The unit can be disconnected from the AC power source by opening this circuit breaker/Isolator.
- If additional AC contactor is used for back feed protection and must comply with IEC/EN 62040-1 (the creep, age and clearance distances shall meet the basic insulation requirements for pollution degree 2).
- Disconnection and overcurrent protection devices shall be provided by others for permanently connected AC input (Normal AC/Bypass AC) and AC output circuits.
- The admissible storage temperature range is -15°C to +40°C with battery, -25°C to +60°C without battery.

## PRODUCT OVERVIEW

FULL PRODUCT DETAILS CAN BE FOUND AT [WWW.CERTAUPS.COM/PRODUCT/CERTAUPS-C300R/](http://WWW.CERTAUPS.COM/PRODUCT/CERTAUPS-C300R/)

The CertaUPS C300R series is an uninterruptible power supply (UPS) incorporating line-interactive technology, which eliminates mains power disturbances.

## THE MODEL LIST

Please check that the unit you have purchased is correct by referring to the model number, which appears on the rear panel of the UPS unit.

ITEM	MODEL NAME	POWER RATING	MODEL TYPE	MODEL DESCRIPTION	OTHER
1	C300R-010-B	1000VA/900W	Rack/Tower	Internal battery model/Charger	Single Phase input Single Phase output
2	C300R-150-B	1500VA/1350W	Rack/Tower	Internal battery model/Charger	Single Phase input Single Phase output
3	C300R-200-B	2000VA/1800W	Rack/Tower	Internal battery model/Charger	Single Phase input Single Phase output
3	C300R-300-B	3000VA/2700W	Rack/Tower	Internal battery model/Charger	Single Phase input Single Phase output

## THE TECHNOLOGY

The C300R UPS series uses line-interactive technology, which ensures that clean and stable power is always provided. A line-interactive UPS operating in line-mode will always provide a consistent supply voltage of AC power to the load. This is done by using an automatic voltage regulator to maintain a steady output voltage while supplied via mains power and a battery and inverter to provide power during a mains failure. When the mains power fails the battery will discharge until it's no longer able to supply the inverter.

Once the battery is depleted the UPS will no longer be able to generate AC power through the inverter and the output will in turn cease. Once the mains power is restored the UPS will provide power to the load once more and the batteries will begin to charge.

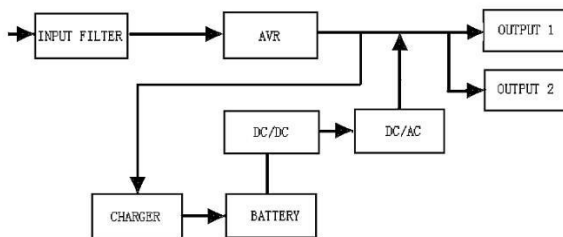

## Key features:

- Wide input voltage window
- 0.9 power factor
- EPO connection
- Future expansion or redundancy
- Rackmount rails included
- Small footprint

## SUITABLE APPLICATIONS

Ideally suited for small to medium-sized offices, telecoms centres and security facilities. Please see list below (not exhaustive):

- Communications
- Networking
- IT facilities
- Telecoms

## ACCESSORIES

PART	DESCRIPTION
C-NMC	SNMP Network management card
C-300REL	Relay card (specific to C300R series)
C-EMP	Environmental monitoring probe (C-NMC required)
C-MOD1	Modbus interface (RS485, 2/4 wire, RTU)
MBSTOWER 1-3	Maintenance bypass switch

## UPS STANDARDS

DESCRIPTION	STANDARD
UPS Safety	IEC/EN 62040-1
EMC	IEC/EN 62040-2
Hazardous Substances	IEC/EN 50581

PLEASE FIND UPS PRODUCT DIAGRAMS AND FULL TECHNICAL SPECIFICATIONS ON PAGE 27 OR VISIT [WWW.CERTAUPS.COM/PRODUCT/CERTAUPS-C300R/](http://WWW.CERTAUPS.COM/PRODUCT/CERTAUPS-C300R/)

## UPS INSTALLATION

PLEASE ENSURE ALL SAFETY INSTRUCTIONS HAVE BEEN OBSERVED AND UNDERSTOOD PRIOR TO UNPACKING AND INSTALLING THE UPS

### INSPECTION

Every effort is made to ensure that CertaUPS systems are packaged as safely as possible to ensure that no damage is incurred during shipment. Please visually inspect the UPS when it is received. Please keep all packaging in a safe place for future use.

IF THE DEVICE IS DAMAGED, PLEASE NOTIFY THE CARRIER IMMEDIATELY

### UNPACKING

The UPS unit must be positioned in a well-ventilated area that is free from excessive dust, heat and moisture. Please take note of the specified operating temperatures and remain within these guidelines.



- Unpacking the unit in a low-temperature environment may cause condensation to occur in and on the device. **DO NOT** install the UPS/EBM until the inside and outside of the device is clear of condensation.
- The UPS/EBM is heavy. Follow any special precautions provided on the carton.
- Unpack the equipment and remove shipping carton and all the packaging materials. **DO NOT** lift the using the front panel and rear panel.

### C300R PACKAGING

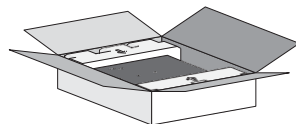
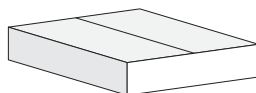

PACKING MATERIALS MUST BE DISPOSED OF IN COMPLIANCE WITH ALL LOCAL WASTE MANAGEMENT REGULATIONS.

RECYCLING SYMBOLS ARE PRINTED ON THE PACKING MATERIALS TO FACILITATE SORTING.

### C300R BOX CONTENTS CHECKLIST

C300R Series UPS	
C12 Input Cable	
C13 Output Cable	
USB A to B	
Software CD	
Quick Start Guide	
Warranty Card	

IF ANY OF THE ITEMS ARE MISSING FROM THE UPS BOX PLEASE NOTIFY YOUR SUPPLIER

DO NOT FORGET TO REGISTER THE UPS WARRANTY [WWW.CERTAUPS.COM/SUPPORT/WARRANTY-REGISTRATION/](http://WWW.CERTAUPS.COM/SUPPORT/WARRANTY-REGISTRATION/)



## UPS INSTALLATION

DO NOT MAKE ANY UNLICENSED MODIFICATIONS TO THE UPS. THIS MAY INCUR DAMAGE AND AFFECT THE UPS WARRANTY.



- **DO NOT** connect the UPS to a mains supply until installation is completed
- Ventilation of the UPS is important for proper operation. Ensure the air vents on the front, side and rear of the UPS are clear. Allow adequate space around the UPS. The airflow diagram is shown as below:

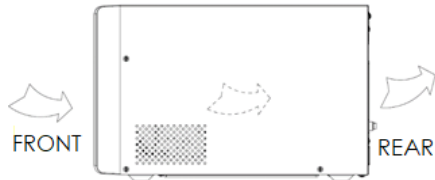

### Installation considerations:

- The final location of the UPS unit must be on a flat stable surface in a well-ventilated environment
- **DO** keep at least 150mm of free space behind the rear panel
- If installing an additional unit, place it next to the first unit in its final location
- **DO** allow the UPS to reach ambient temperature before turning on
- The UPS needs to be fully charged to achieve full autonomy



## C300R TOWER INSTALLATION

A QUICK START VIDEO GUIDE FOR THE C300R TOWER MODEL IS AVAILABLE AT [WWW.CERTAUPS.COM/MEDIA](http://WWW.CERTAUPS.COM/MEDIA)

### Tools required:

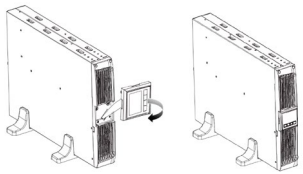
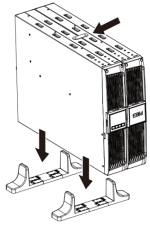
- Insulated screwdriver
- Correctly rated and fused loose cable

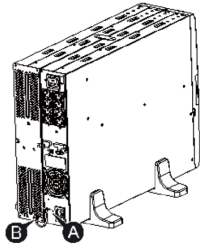
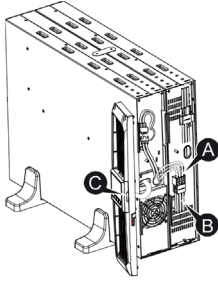
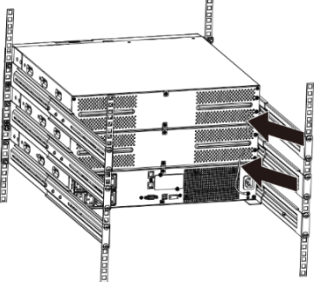
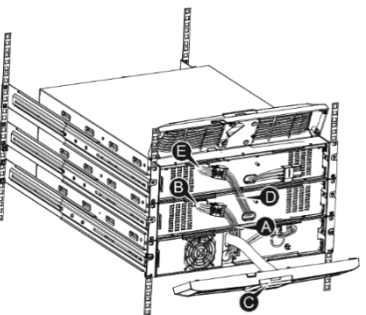
STEP ONE	Ensure utility power is switched off.
STEP TWO	Carefully place the UPS within the stands.
STEP THREE	<p>Pull out the LCD panel and carefully rotate it taking care not to damage the cable.</p> 
STEP FOUR	<p>If not installing additional EBMs skip to step six</p> <p>Position the UPS and EBM within the extended UPS stands then slide the stands to either end of the tower as well as the coupling plate on top and tighten the screws for stabilisation.</p> 



	<p>Connect an Earth line from the UPS (port A) to the EBM (port B)</p>  <p>Take off the front panel. To do this remove the 2 screws from the right-hand side of the front of the UPS and carefully take out the LCD screen to remove the screw that is behind it. Finally, push inward the small blanking plate on the side of the front panel in order to remove it. This then enables you to connect the battery terminal (A) from the UPS to the EBM terminal (B) shown below. After doing this, reassemble the front panel</p>  <p>After setting up the UPS the load can then be connected. Please make sure the load equipment is turned off before connecting all loads into the output C13/C19 ports</p>
<p>STEP FIVE</p>	<p>If not connecting multiple EBMs skip to step six</p> <p>To connect to multiple EBMs use the same method as assembling the EBM into the rack mounting. To install multiple EBMs connect an Earth line between the UPS and the first EBM and then connect a second Earth line between the first EBM and the second EBM</p>  <p>Take off the front panel as instructed in the previous steps. This then enables you to connect the battery terminal (A) from the UPS to the EBM terminal (B) shown below. Then connect the battery terminal (D) from the first EBM to the battery terminal (E) of the second EBM. The user then needs to reassemble the front panel.</p> 
<p>STEP SIX</p>	<p>Plug the UPS into a mains power socket and turn Utility power 'ON'. The UPS will power on in bypass mode and begin charging</p>
<p>STEP SEVEN</p>	<p>Switch the UPS from standby mode to on. Press and hold  for longer than 3 seconds. Once the unit has run a test the LCD display will show the output voltage and that the UPS is powered and protecting the equipment</p>

## C300R RACKMOUNT INSTALLATION

A QUICK START VIDEO GUIDE FOR THE C300RR RACKMOUNT/TOWER MODEL IS AVAILABLE AT [WWW.CERTAUPS.COM/MEDIA](http://WWW.CERTAUPS.COM/MEDIA)

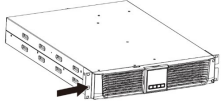
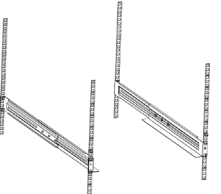
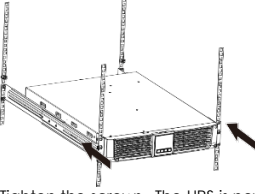
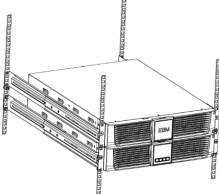
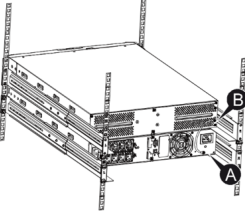
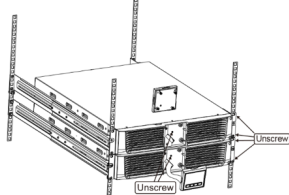

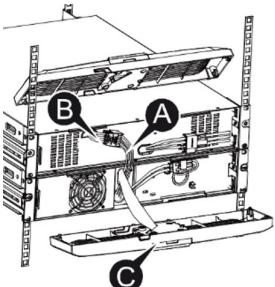
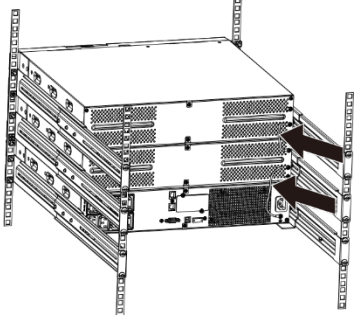
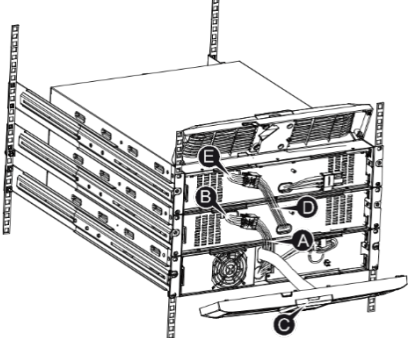
This series of UPS can be placed horizontally and vertically, with the LCD screen rotating 90 degrees.

STEP ONE	<p>Ensure the master input breaker switch is OFF</p>
STEP TWO	<p>Installing the UPS in a rack position:</p> <p>Install the L bracket to the unit</p>  <p>Install the unit to the rack cabinet in a suitable U-space (Pre-install rail kit)</p>  <p>Slide the UPS into the rack rails and lock it into the rack enclosure</p>  <p>Tighten the screws. The UPS is now ready for cabling unless you are installing EMBs.</p>
STEP FOUR	<p>If not installing additional EMBs skip straight to step six.</p> <p>Using the same method as assembling the UPS in rack form, assemble the EBM into the rack mounting above or below the UPS</p>  <p>Connect the earth line between mounting point A &amp; B</p>  <p>Remove the display panel, and unscrew the internal screws</p> 

	<p>Take off the front panel. To do this remove the 2 top screws from the front of the UPS and carefully take out the LCD screen and remove the screw.</p> <p>Finally, push inward the small blanking plate on the side of the front panel in order to remove it. This then enables you to connect the battery terminal (A) from the UPS to the EBM terminal (B) shown below. After doing this reassemble the front panel.</p> 
<p>STEP FIVE</p>	<p>If 1 or fewer EBMs are to be connected skip to step six</p> <p>To install multiple EBMs connect an Earth line between the UPS and the first EBM and then connect a second Earth line between the first EBM and the second EBM</p>  <p>Take off the front panel as instructed in the previous steps. This then enables you to connect the battery terminal (A) from the UPS to the EBM terminal (B) shown below. Then connect the battery terminal (D) from the first EBM to the battery terminal (E) of the second EBM. The user then needs to reassemble the front panel</p> 
<p>STEP SIX</p>	<p>Plug the UPS into a mains power socket and turn the power on. The UPS will power on in bypass mode and begin charging</p>
<p>STEP SEVEN</p>	<p>Switch the UPS from bypass mode to online. Press and hold  for longer than 3 seconds. Once the unit has run a test the LCD display will show the output voltage and that the UPS is powered and protecting the equipment</p>

## C300R SERIES STARTUP AND SHUTDOWN





### STARTING THE UPS WITH MAIN POWER PRESENT

-  Please switch off the connected loads before turning on the UPS, and switch on connected devices one by one after the UPS is turned on. Switch off all connected loads before turning off the UPS.
-  The C300R Series UPS can be started either "hot" or "Cold", this means the UPS can be activated regardless of whether the unit has a main supply (Hot) or if no mains power is available (Cold).
-  Verify that the total equipment ratings do not exceed the UPS capacity to prevent an overload alarm.



To start the UPS via mains power (Hot start):

1. Check all the connections are properly connected and correct.
2. Supply mains power to the UPS, the fans will start and the LCD will show the default UPS status summary screen.
3. Hold the  button continuously for more than 3 seconds the fan will run and the UPS starts to turn on.
4. After a few seconds, the UPS will start in Line-interactive mode. If the utility power is abnormal, the UPS will transfer to battery mode without output interruption to the UPS.

### STARTING THE UPS FROM BATTERY

-  Before using this feature, the UPS must have been powered by utility power with output enabled at least once to ensure the unit is adequately charged.
-  After connecting the UPS to the External battery module (EBM), should wait for 10s before pressing the  button to allow for pre-charging the auxiliary power supply.
-  Battery start can be disabled.

To start the UPS via battery power (Cold start):

1. Check all the connections are properly connected and correct.
2. Press the  button continuously for more than 1 second, the UPS will power on. The fans will start and the LCD will show the default UPS status summary screen after finishing the initialisation self-test.
3. Pressing the  button continuously again for more than 3 seconds the UPS will start to turn on.
4. After a few seconds, the UPS will transfer to battery mode. If the mains power comes back the UPS will transfer to Line mode without output interruption of the UPS.

### UPS SHUTDOWN WITH MAINS POWER

To shutdown the UPS with mains power:

1. Press the  button continuously for more than 1 second.
2. After that, the UPS will transfer to standby mode immediately.
3. All output will cease and the display will show no output.

## UPS SHUTDOWN WITHOUT MAINS POWER

To shutdown the UPS without mains power:





1. Power off the UPS by pressing the  button continuously for more than 3 seconds at which point the UPS output will stop.
2. A few seconds later the LCD display will power off.

## C300R SERIES OPERATION

### FRONT PANNEL





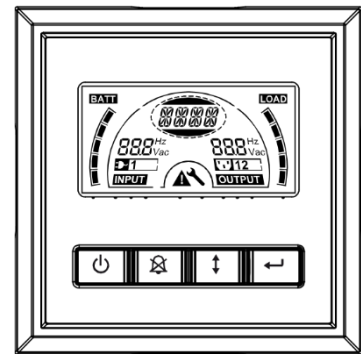

The CertaUPS C300R has a four-button graphical LCD. It provides useful information about the UPS itself, load status, events, measurements and settings.

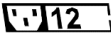

The following table shows the indicator status and description:

BUTTON	FUNCTION	DESCRIPTION
	To turn the UPS on/off	To turn the UPS on/off. Press and hold the power button for longer than 3 seconds.
	Clearing fault indication	Disconnect the mains input to the UPS and then press and hold the power button for longer than 2 seconds to shut down the UPS.
	Silence	Press the button for one second.
	Function Test	Press and hold the button for 3 seconds
	Battery Test	Press and hold the button for 10 seconds
	Select Button	Press the Select button to scroll through the settings one by one
	Flash	The UPS is on Standby mode.



The following table shows the indicator status and description:

ITEM	DESCRIPTION	FUNCTION
	Input frequency and voltage	Indicates the value of input frequency and voltage.
	Input plug indicator	This light switches on when the UPS is charging from the mains.
	Output frequency and voltage	Indicates the value of output frequency and voltage.
	Output plug indicator	The UPS has two groups of outlets. The output plug indicator will light up if these outputs are enabled.
	UPS/user setting display status	Indicates the UPS current mode of operation or Indicates the settings currently being altered by the user.
	Warning indication light	This light will turn on when the UPS alarm is active or if there's an error that is causing the UPS to malfunction.
	Settings icon	This light will turn on when the UPS is within settings mode.

	Battery capacity level indicator	This light indicates the amount of battery capacity remaining. Each battery capacity level bar indicates 20% of the total battery capacity.
	Load capacity level indicator	Indicates the percentage of the UPS load capacity which is being used by the protected equipment. Each LCD level bar indicates 20% of the total UPS output capacity.

IF AN ERROR CODE APPEARS PLEASE REFER TO THE ALARMS AND FAULTS SECTION OF THE MANUAL PAGE 25 OR CONTACT YOUR CertaUPS REPRESENTATIVE

## LCD DESCRIPTION

The table below gives details on the information provided by the UPS:







IF ANY OTHER STATUS APPEARS, OR FOR FURTHER GUIDANCE ON WHAT TO DO PLEASE SEE THE TROUBLESHOOTING SECTION ON PAGE 25 OR CONTACT A CertaUPS REPRESENTATIVE

OPERATION STATUS	CAUSE
STbY	The UPS is currently in standby mode.
IPVL	The input voltage is too low. (below minimum operating conditions)
IPVH	The input voltage is too high. (above maximum operating conditions)
IPFL	The input frequency is too low. (below minimum operating conditions)
IPFH	The input frequency is too high. (above maximum operating conditions)
NORM	The UPS is operating under normal conditions. Equipment is being powered from the mains supply, not from the UPS batteries.
AVR	The UPS is operating in AVR mode.
bATT	The UPS is providing power to equipment from the UPS batteries. This will occur if there's a problem with the mains supply. UPS will follow shutdown procedures established using the WinPower Software.
TEST	The UPS is currently set to perform tests on the batteries.
OPVH	Displayed during battery operation if the input voltage is too high. (above maximum operating conditions)
OPVL	Displayed during battery operation if the input voltage is too low. (below minimum operating conditions)

## SETTINGS MENU

The LCD display can be used to access detailed information about the current UPS status as well as configure the UPS settings.

The UPS is controlled using basic button functions via the LCD panel, to access and configure the UPS

- Press and hold the Enter button  for longer than 3 seconds. This will cause the UPS to go into settings mode.
- Press the Select button  to cycle through the setting items shown in the table below.
- When the LCD displays the setting that requires amendment, press the enter button  for longer than one second to enter the option and amend the value.
- Press the Select button  to select the value of the setting.
- Press and hold the Enter button  for one second, the UPS will then return to settings mode.
- Press and hold the Enter button  for 3 seconds or the power button  for 0.5 seconds to exit settings mode

LCD DISPLAY	DISPLAY MEANING	SETTINGS
OPV	Output voltage mode selection	[220]= 220V [230]= 230V [240]= 240V
AVR	Input type selection	[000]= Normal range mode [001]= Wide range mode [002]= Generator mode
EbM	External battery module (EBM) settings	0-9 is the number of external battery module(s)
TEST	Auto self-test function	[000]=Disable[001]=Enable
AR	Automatic restart	[000]=Disable[001]=Enable
GF	Green function	[000]=Disable[001]=Enable
bZ	Buzzer control	[000]=Disable[001]=Enable
LS1	Load segment 1	[000]=Turn off[001]=Turn on
LS2	Load segment 2	[000]=Turn off[001]=Turn on

BY DEFAULT, THE LCD WILL DISPLAY THE UPS STATUS SUMMARY SCREEN.



## COMMUNICATION PORTS

### RS232/USB



The RS232 and USB communication ports cannot be used simultaneously.

- Connect the communication cable to the serial or USB port on the computer.
- Connect the other end of the communication cable to the RS232 or USB communication port on the UPS.

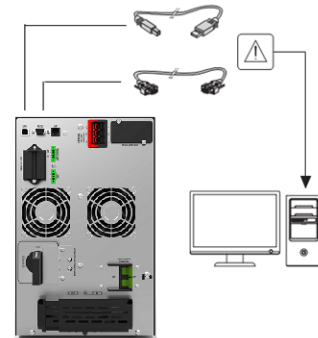

Both RS232 and USB connections allow for 2 way communication between the device connected and the UPS. This can be used for both issuing configuration commands, communicating with the UPS and issuing shutdown commands. When connected via USB to a PC the UPS will present itself as a HID compliant ACPI device allowing for zero configuration shutdown initiated by the UPS in the event of a power failure.

### EPO CONNECTION

The EPO (Emergency Power Off) connection allows the UPS to be powered off by changing the state of a normally closed circuit.

- Normally closed - Normally EPO connector is closed with a wire on the rear panel. Once the connector is open, the UPS will stop output until the EPO status is disabled.



ENABLE EPO STATUS

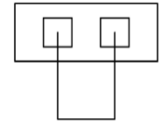

DISABLE EPO STATUS

### INTERFACE CARDS (OPTIONAL)

The Network Management Card allows the UPS to communicate with monitoring devices by utilising network connectivity. The C300R series has one available expansion bay for the following connectivity cards:

- NMC/SNMP Card – this interface card provides SNMP and HTTP capabilities as well as monitoring through a Web browser interface using RJ45 10/100Mbps over TCP/IP.
- AS400 card - for RS485 communication protocol. Please contact your Cert UPS partner for details.

## SOFTWARE

The C300R series is compatible with WinPower which is an open-source, online UPS monitoring and management software tool.

Key features:

- Power flow display for monitoring UPS status
- Scheduled system shutdown/restart
- Warning notification via E-mail / SMS / Windows system log\*
- Scheduled UPS test
- Password security protection
- Remote monitor/control via LAN
- Safety to shutdown multi-system
- Selectable User Interface (Background)
- UPS parameter setting
- SNMP Central monitoring up to 1000 units
- Record logs for analysis
- Multi-language support: English, Italian, Turkish, Spanish, French, Portuguese, Polish, Thai, Germanic, Russian and Japanese.

\*Requires a GSM modem (not supplied)

WinPower installation:

STEP ONE	Go to: <a href="https://www.certaups.com/downloads/">https://www.certaups.com/downloads/</a> download winpower
STEP TWO	Choose the operating system you need and follow the instruction described on the website to download the software.
STEP THREE	When downloading all the required files from the internet, enter the product key: <b>511C1-01220-0100-478DF2A</b>

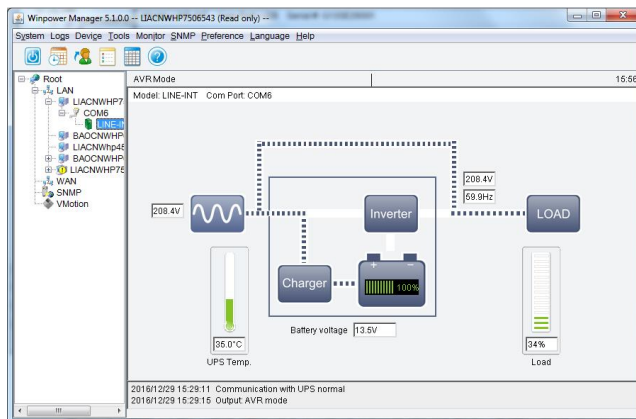

WHEN THE INSTALLATION IS COMPLETE, WinPOWER WILL APPEAR AS A GREEN PLUG ICON LOCATED IN THE SYSTEM TRAY, NEAR THE CLOCK.

FOR FURTHER GUIDANCE ON UPS MONITORING, PLEASE CONTACT YOUR CertaUPS PROVIDER OR VISIT [WWW.CERTAUPS.COM](http://WWW.CERTAUPS.COM)

## UPS MAINTENANCE

ADOPTING A PREVENTATIVE MAINTENANCE SCHEDULE IS CRITICAL TO ACHIEVING OPTIMUM UPS PERFORMANCE

### UPS CARE

For the best preventive maintenance:

Keep the area around the equipment clean
Keep the equipment free from dust
Ensure the equipment is positioned in a well-ventilated area
For maximum battery life keep the equipment at an ambient temperature of 20-25°C (77°F max)
Carry out regular environmental and battery checks



The batteries are rated for a 3-5 year service life. The service life varies depending on the frequency of usage and ambient temperature. Batteries used beyond expected service life will often have severely reduced runtimes. Replace batteries at least every 4 years to keep units running at peak efficiency and prevent failure.

### TRANSPORTING THE UPS



THE INTERNAL UPS BATTERIES MUST BE DISCONNECTED BEFORE TRANSPORT



The following procedure should be performed or supervised by personnel knowledgeable about batteries and the required precautions. Keep unauthorised personnel away from batteries. If the UPS requires any type of transportation, the batteries must be disconnected (but not removed) before the unit is transported:

Verify that the UPS is off and disconnected from mains power
Place the UPS on a flat stable surface with the front of the cabinet facing you
Remove the UPS front cover
Disconnect the internal battery connectors
Replace the UPS front cover

To avoid damage and to prevent DOA's always use a reputable courier for all equipment transportation.

### STORING THE UPS

UPS BATTERIES MUST BE RECHARGED EVERY SIX MONTHS. ALWAYS CHECK THE BATTERY RECHARGE DATE ON THE SHIPPING CARTON BEFORE USE.

Where UPS equipment is stored for a long period of time, the batteries must be recharged every six months. The optimal storage vdc for VRLA batteries, depending on the environment is between 20-40%. This can be achieved by connecting the UPS to mains power.

DO NOT store the equipment in a warm, damp, dusty environment	
DO NOT use the equipment if the batteries have not been recharged/if the recharge date exceeds six months	
DO NOT Expose the UPS to direct sunlight or source of heat	
DO Store the equipment in a cool, dry, clean environment	
DO Ensure the batteries are recharged every six months for a minimum of 48 hours	
DO Ensure EBMs are recharged every six months for a minimum of 3 hours	

## BATTERY REPLACEMENT



DO NOT DISCONNECT THE BATTERIES WHILE THE UPS IS IN BATTERY MODE



CONSIDER ALL WARNINGS, CAUTIONS, AND NOTES BEFORE REPLACING BATTERIES



ELECTRIC ENERGY HAZARD. DO NOT ATTEMPT TO ALTER ANY BATTERY WIRING OR CONNECTORS.

DO NOT Allow unauthorised personnel near the batteries. Servicing should be performed by qualified, knowledgeable personnel only	
DO NOT Dispose of batteries in a fire. Batteries may explode when exposed to flame	
DO NOT Open or modify the battery or batteries in any way. Released electrolyte is harmful to the skin and eyes and maybe extremely toxic	
DO NOT Attempt to alter any battery wiring or connectors. Attempting to alter wiring can cause injury	

DO Ensure personnel servicing the batteries are all knowledgeable on the required precautions for battery servicing	
DO Replace the batteries with the same type and number of batteries or battery packs	
DO Dispose of the batteries responsibly. Please refer to local regulations and disposal requirements	
DO Determine if the battery is inadvertently grounded. If inadvertently grounded, remove source to ground. Contact with any part of a grounded battery can result in electrical shock. The likelihood of shock can be reduced if grounds are removed during installation and maintenance (applicable to equipment and remote battery supplies not having a grounded supply circuit).	
DO Disconnect charging source prior to connecting or disconnecting battery terminals	

Batteries can present a risk of electrical shock or burn from high short circuit current. Observe the following precautions:

Remove watches, rings, or other metal objects
Use tools with insulated handles
Do not lay tools or metal parts on top of batteries
Wear rubber gloves and boots

## REPLACING THE EBM



THE EBM IS HEAVY AND REQUIRES A MINIMUM OF 2 PEOPLE TO LIFT INTO RACKING.



ALWAYS ENSURE ANY NEW EBMS ARE OF THE SAME VOLTAGE AS THESE BEING REPLACED.

For the C300RR rotation module: If a Power distribution unit (PDU) is connected to the UPS, turn the Mains Bypass Switch (MBS) to bypass and switch off the input, it is then safe to replace the EBM(s). If a PDU is not connected to the UPS, turn off the UPS and disconnect from the mains supply before then replacing the EBM.

To replace the EBM(s):

1. Unplug the EBM power cable and battery detection cable from the UPS. If additional EBM(s) are installed, unplug the EBM power cable from each EBM
2. Replace the EBM(s)



A SMALL AMOUNT OF ARCING MAY OCCUR WHEN CONNECTING AN EBM TO THE UPS. THIS IS NORMAL AND WILL NOT CAUSE SHOCK. INSERT THE EBM CABLE INTO THE UPS BATTERY CONNECTOR QUICKLY AND FIRMLY

- Plug the EBM cable(s) into the battery connector(s)
- Verify that the EBM connections are secure and that adequate bend radius and strain relief exist for each cable
- Connect the EBM cable to the UPS

To test new batteries:

1. Charge the batteries for 48 hours.
2. Press and hold the  button for 10 seconds to start the battery test.
3. Select Single battery test

The UPS starts a battery test if:

- The batteries are fully charged
- The UPS is in Normal mode with no active alarms
- Bypass voltage is acceptable

During the battery test, the UPS transfers to Battery mode and discharges the batteries for 10 seconds. The front panel displays "TEST" and the percentage of the test completed.

## RECYCLING A UPS



CONTACT YOUR LOCAL RECYCLING OR HAZARDOUS WASTE CENTRE FOR INFORMATION ON PROPER DISPOSAL OF THE USED EQUIPMENT.

**DO NOT** dispose of the battery or batteries in a fire. Batteries may explode. Proper disposal of batteries is required. Refer to your regulations for disposal requirements.

**DO NOT** open or modify the battery or batteries. Released electrolyte is toxic and harmful to the skin and eyes.



**DO NOT** discard the UPS or the UPS batteries in the general waste. This product contains sealed lead-acid batteries and must be disposed of responsibly. For more information contact your local recycling centre.



**DO NOT** discard of waste electrical or electronic equipment (WEEE) in the trash. For proper disposal contact your local recycling centre.

## TROUBLESHOOTING

The C300R series is designed for durable, automatic operation. It also provides alerts whenever potential operating problems occur.

ALARMS SHOWN ON THE CONTROL PANEL DO NOT MEAN THAT THE OUTPUT POWER IS AFFECTED. INSTEAD THEY ARE PREVENTIVE ALARMS INTENDED TO ALERT THE USER

- Events are silent status indicators. Example = "AC freq in range".
- Faults are announced by a continuous beep. Example = Out. Short circuit.

## ALARMS & FAULTS

TO REGISTER A FAULT PLEASE VISIT [WWW.CERTAUPS.COM/SUPPORT/FAULT-REPORTING/](http://WWW.CERTAUPS.COM/SUPPORT/FAULT-REPORTING/)

Use the following troubleshooting chart to determine the UPS alarm condition.

ALARM CODE	CAUSE	ACTION
OPST	Output short detected	Remove all loads and identify the cause of the short, once the short is cleared turn the UPS back on.
OVLD	The UPS output is overloaded	Remove non-critical loads Check for failed connected devices
bATH	The battery voltage is too high	Contact your service representative
bATL	The battery voltage is too low	Contact your service representative
OVP	The internal temperature of the UPS is too high	Ensure adequate ventilation and ambient temperature
FNLK	The UPS fan is locked	Contact your service representative
bTWK	The batteries are weak and require recharging or replacing	Contact your service representative
SITE	Site wiring fault	Check input wiring for fault
FANF	UPS has confirmed fan failure	Contact your service representative
HIGH	Battery over-voltage (overcharged)	Confirm correct EBM is installed, the UPS will switch to battery and discharge to the correct Vdc
bLOW	The battery is almost empty	Prepare for imminent shutdown, Supply UPS with utility power
CHGF	Charge failure	Contact your service representative
TEPH	Inverter temperature high	Ensure adequate ventilation and ambient temperature
bOPN	Battery circuit open	Confirm EBM is correctly attached
dCHF	Digital charger fail	Contact your service representative
ITPH	Internal temperature high	Contact your service representative

SHOR	Inverter short	Check UPS output for possible short circuit
ISFT	Inverter soft start fail	Contact your service representative
bSFT	Bus soft start fail	Contact your service representative
OVTP	Over temperature fault	Ensure adequate ventilation and ambient temperature
INVL	Inverter voltage low	Contact your service representative
INVH	Inverter voltage high	Contact your service representative
bUSH	BUS overvolt	Contact your service representative
bUSL	BUS under volt	Allow time for the Batteries to charge
		Contact your service representative
bUSS	BUS short circuit	Contact your service representative
NTCO	Inverter NTC open	Contact your service representative
EPO	Emergency power off	EPO connection has changed state

## SILENCING THE ALARM

- Press the  button for one second. Seconds to silence the alarm.



Check the alarm condition and perform the applicable action to resolve the condition.



If an alarm status changes the alarm will need to be silenced again.

## TESTING THE BATTERIES

When initiating a battery test

- Ensure the batteries are fully charged
- The UPS must be in normal mode with no active alarms
- Do not connect or disconnect equipment

To start the battery test

- Connect the UPS to mains power for at least 48 hours to charge the batteries
- Press and hold the  button for 10 seconds to start the battery test. The status display string will show "TEST"

## TECHNICAL DATA

### BLOCK DIAGRAM

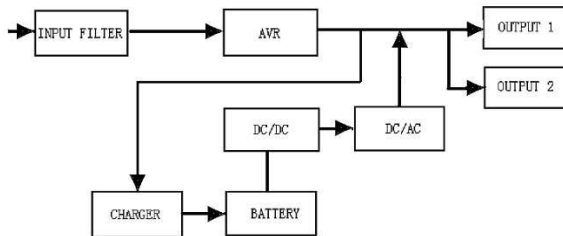

### ELECTRICAL SPECIFICATION

INPUT				
Model No.	C300R-010-B	C300R-015-B	C300R-020-B	C300R-030-B
Phase	Single			
Frequency	40~70 Hz			
Voltage (V)	220/230/240VAC	220/230/240VAC	220/230/240VAC	220/230/240VAC
Current (A)	230V @ 5.2A	230V / 7.5A	230V / 9.5A	230V / 13A
OUTPUT				
Model No.	C300R-010-B	C300R-015-B	C300R-020-B	C300R-030-B
Power rating*	1000VA/900W	1500VA/1350W	2000VA/1800W	3000VA/2700W
Voltage	220Vac/230Vac/240Vac			
Frequency	50/60Hz			
Waveform	Pure Sinewave			
BATTERIES				
Model No.	C300R-010-B	C300R-015-B	C300R-020-B	C300R-030-B
Voltage	36V	36V	72V	72V
Capacity	7ah x 6	7 ah x 6	9 ah x 6	9 ah x 6

### OPERATING ENVIRONMENT

Ambient Temperature	0°C to 40°C (Full load no de-rating) 40°C to 50°C output power derated to 50% load, Charger current derated 50%
Operating humidity	< 95% no condensing
Altitude	< 3000m
	3000m (Above 3000m altitude 10% derating per 1000m)
Storage temperature	-25°C~55°C (-13 to 130°F)

\*Above 3000m altitude 10% derating per 1000m.



## RUNTIMES

MODEL	EMB CODE	EBM QTY	RUNTIME @ 100%	RUNTIME @ 75%	RUNTIME @ 50%	RUNTIME @ 25%
C300R-010-B	NA	0	2 Mins	4 Mins	9 Mins	46 Mins
C300R-010-B	C300R-BB36VP	1	18 Mins	26 Mins	43 Mins	108 Mins
C300R-010-B	C300R-BB36VP	2	34 Mins	48 Mins	89 Mins	204 Mins
C300R-015-B	NA	0	1 Mins	2 Mins	4 Mins	15 Mins
C300R-015-B	C300R-BB36VP	1	9 Mins	15 Mins	27 Mins	60 Mins
C300R-015-B	C300R-BB36VP	2	21 Mins	30 Mins	50 Mins	118 Mins
C300R-020-B	NA	0	2 Mins	4 Mins	9 Mins	26 Mins
C300R-020-B	C300R-BB72VP	1	18 Mins	27 Mins	44 Mins	108 Mins
C300R-020-B	C300R-BB72VP	2	35 Mins	50 Mins	92 Mins	204 Mins
C300R-030-B	NA	0	1 Mins	2 Mins	4 Mins	15 Mins
C300R-030-B	C300R-BB72VP	1	9 Mins	15 Mins	27 Mins	60 Mins
C300R-030-B	C300R-BB72VP	2	21 Mins	30 Mins	50 Mins	118 Mins

\*Calculated to 20°C

## DIMENSIONS AND WEIGHTS

Model No.	Dimensions W×H×D (mm)	Net Weight (kg)
C300R-010-B	438 x 86.5 x 436	17.8
C300R-015-B	438 x 86.5 x 436	17.8
C300R-020-B	438 x 86.5 x 608	27.8
C300R-030-B	438 x 86.5 x 608	32.0
C300R-BB36VP	438 x 86.5 x 436	20.5
C300R-BB72VP	438 x 86.5 x 608	33.3

A FULL GLOSSARY OF TERMS CAN BE FOUND AT:  
[WWW.CERTAUPS.COM/SUPPORT/UPS-GLOSSARY/](http://WWW.CERTAUPS.COM/SUPPORT/UPS-GLOSSARY/)

FOR FURTHER INFORMATION OR ASSISTANCE, PLEASE CONTACT YOUR CertaUPS REPRESENTATIVE OR VISIT:  
[WWW.CERTAUPS.COM](http://WWW.CERTAUPS.COM)