

## Installation Instruction

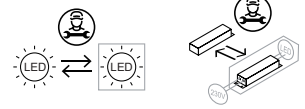

Product Code:TOL-25-130-80  
TOL-25-130-100

Product Description:TOLOSA BOLLARDS



### Important Information

- ◆ It is recommended that luminaires are installed / maintained by a fully qualified electrician and wired in accordance to the latest IEC standards or national equivalent.
- ◆ Mains power must be switched off during any installation or maintenance.
- ◆ This product is guaranteed for a period of 5 years from date of purchase. The guarantee is invalid in the case of improper use, improper installation or tampering. Should the product fail during the guarantee period it will be replaced free of charge, subject to correct installation and return of the faulty unit. The manufacturer is not responsible for any costs associated with the replacement of this product.
- ◆ This product may contain substances that can be hazardous to the environment if not disposed of properly. Electrical and electronic equipment should never be disposed of with general household waste but must be separated for its correct treatment and recovery. Where possible recycle your packaging.
- ◆ This product contains a light source of energy efficiency class E.

### Dimension

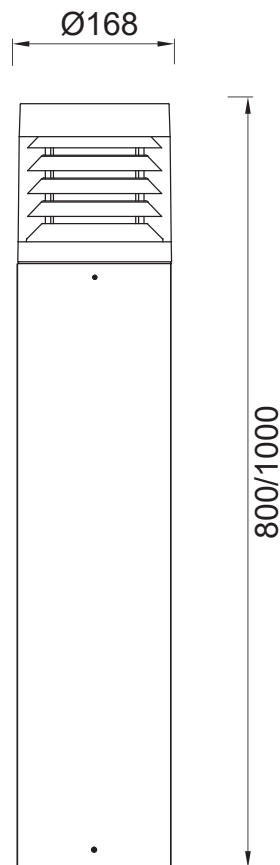

## Installation Instruction

1

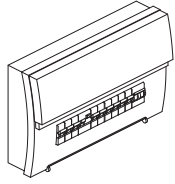

ALWAYS SWITCH OFF THE  
MAINS SUPPLY BEFORE  
INSTALLATION OR SERVICING

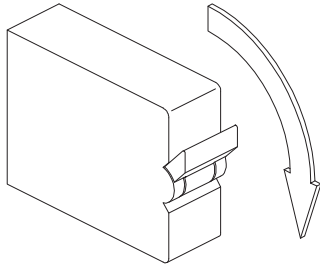

2

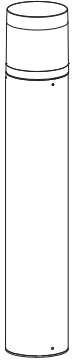
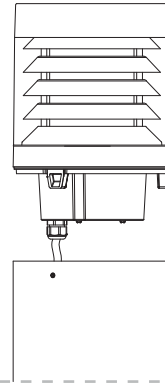

3

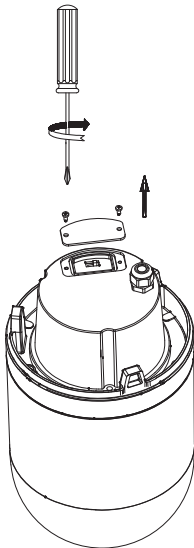

4

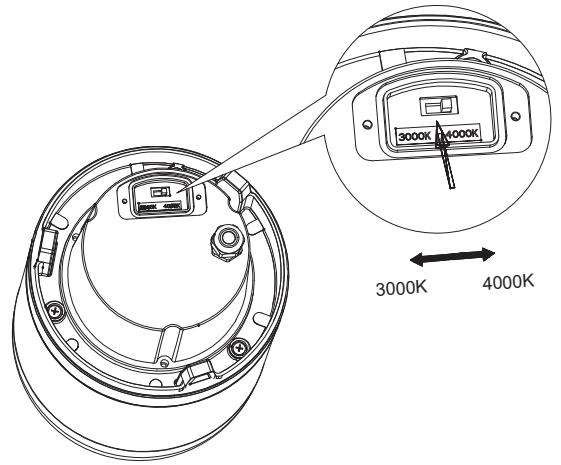

5

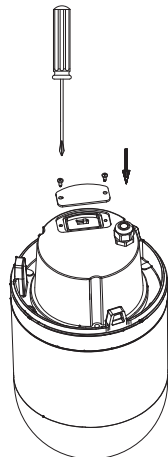

6

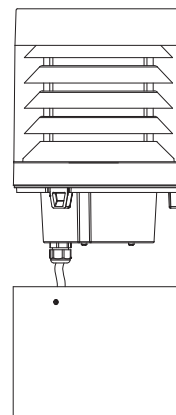

## Installation Instruction

7



8

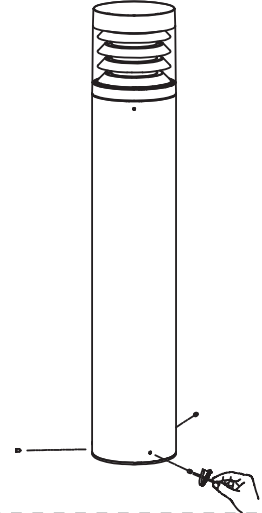

9

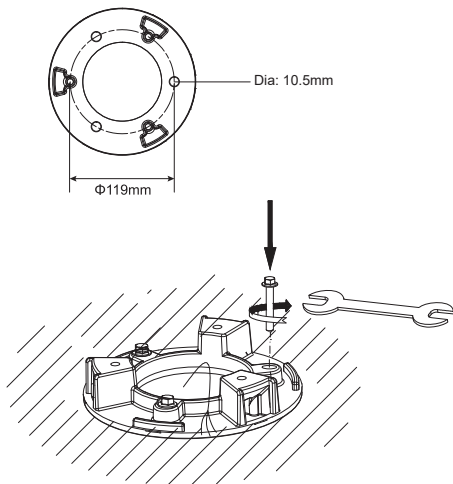

10

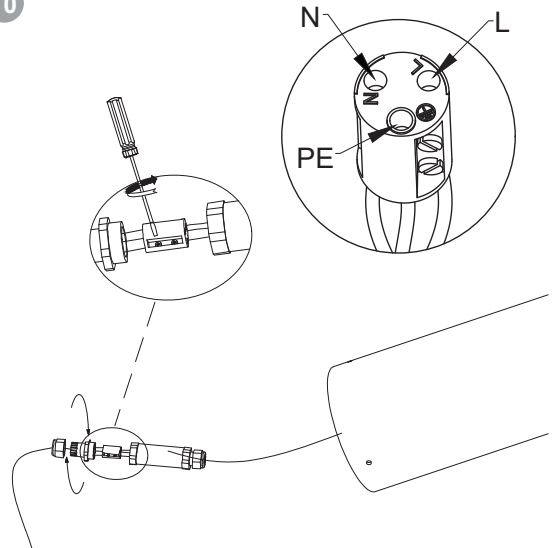

11

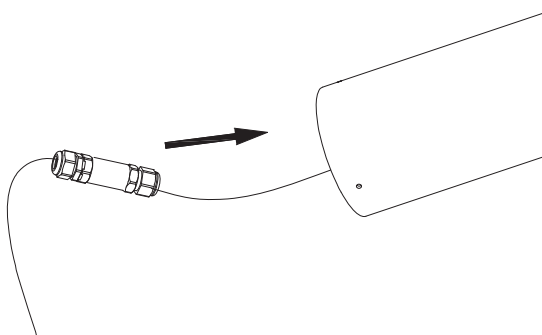

12

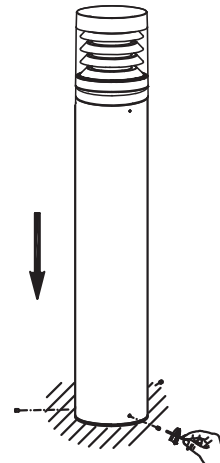

## Installation Instruction

