

Product Code: CU1RCBO16B10

Luckinslive 437535821

Description: 1 Pole + Unswitched Neutral True 10kA B Curve 16A RCBO 30mA Trip (Type A)

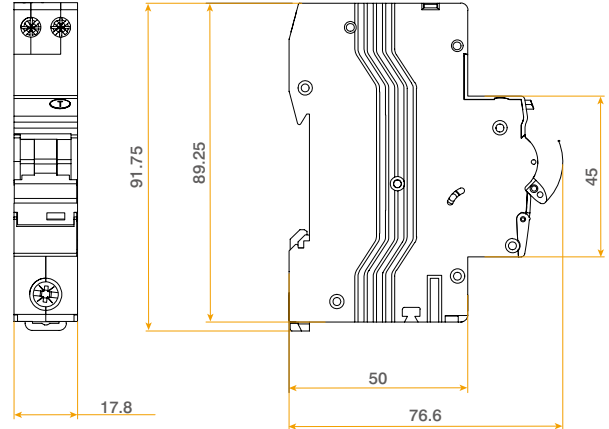

General Information

Dimensions (mm)	17.8 (W) x 91.8 (H) x 76.6 (D)
Colour	Light Grey
Rated Operational Voltage (AC) (Ue)	240
Frequency (Hz)	50/60
Maximum Rated Current (A) (In)	16
Rated Breaking Capacity (True kA) (Ics)	10
Impulse Withstand Voltage (Uimp)	4000
Endurance Mechanical Operations	20000
Endurance Electrical Operations	5000
Type	A
Trip Curve	B
Rated Making & Breaking Capacity (A) (Im)	500
Tripping Current (mA) (in)	30
Residual Non-Operating Current (IΔn)	0.5
Trip Type	Ground Fault: Electronic/Electromagnetic Over Current: Thermal/Magnetic
Device Terminals	Screwed Lug & Pin
Number Of Poles	1P + Unswitched Neutral
Input Terminal Capacity - Flexible (mm ²)	25
Input Terminal Capacity - Rigid (mm ²)	32
Input Terminal Torque (Nm)	2
Output Terminal Capacity - Flexible (mm ²)	16
Output Terminal Capacity - Rigid (mm ²)	25
Output Terminal Torque (Nm)	1.2
Circuit Protection	Earth fault, overcurrent & short-circuit
Neutral Tail Length (mm)	1000
Ingress Protection	IP20
Operational Temperature (°C)	-25 to +40
Warranty (Years)	3
Standards	BS EN 61009-1

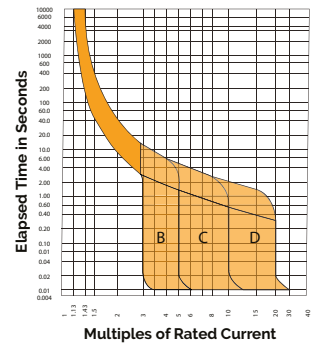

Additional Information

For cleaning / polishing of products, use only a soft, dry, clean cloth.
The RCBOs within our distribution boards are designed to withstand insulation resistance tests at 500V.
Recommended screwdriver: Input - PZ2, Output - PZ1

