

Product Code: CU3MCB50C10

Luckinslive 437536176

Description: 3 Pole True 10kA C Curve 50A MCB

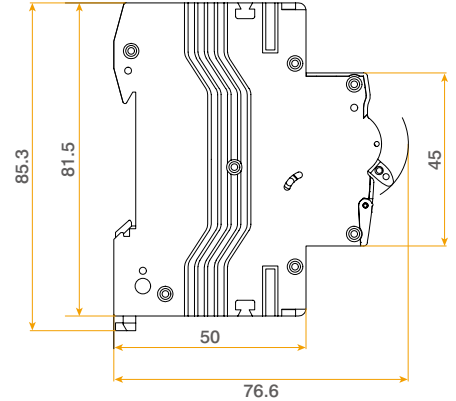
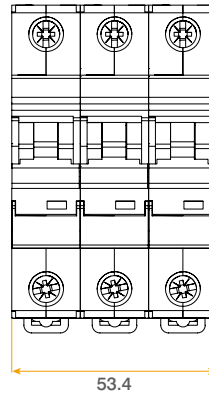

### General Information

Dimensions (mm)	53.4 (W) x 85.3 (H) x 76.6 (D)
Colour	Light Grey
Rated Operational Voltage (AC) (Ue)	230/400
Frequency (Hz)	50/60
Maximum Rated Current (A) (In)	50
Rated Breaking Capacity (True kA) (Ics)	10
Rated Insulation Voltage (V) (Ui)	500
Impulse Withstand Voltage (Uimp)	4000
Endurance Mechanical Operations	10000
Endurance Electrical Operations	4000
Trip Curve	C
Trip Type	Thermal/Magnetic Release
Thermal Operating limit	(1.13-1.45) x In
Magnetic Operating Characteristics	(5-10) x In
Device Terminals	Screwed Lug & Pin
MCB Terminal Capacity - Flexible (mm <sup>2</sup> )	25
MCB Terminal Capacity - Rigid (mm <sup>2</sup> )	35
MCB Terminal Torque (Nm)	2
Number Of Poles	3
Ingress Protection	IP20
Operational Temperature (°C)	-5 to +40
Warranty (Years)	3

**Standards** BS EN 60898-1

**Additional Information** For cleaning / polishing of products, use only a soft, dry, clean cloth.

