

743X40

Hartland | HARTLAND RANGE | Resistive Leading Edge Push On/Off Rotary 2 Way Switching Dimmers

Item Image



Wiring

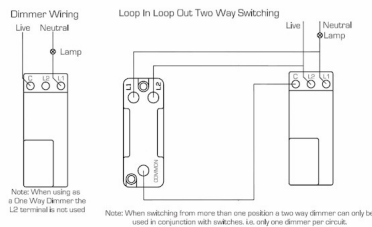



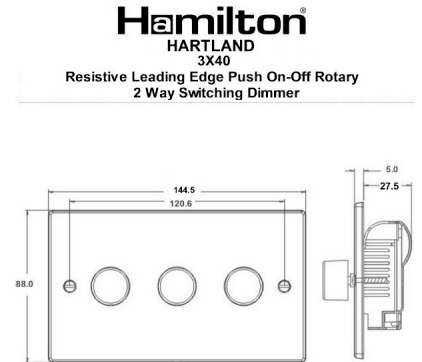



Dimensions



Primary Range	Hartland
Insert Type	3 gang 400w Resistive Leading Edge Push On/Off Rotary 2 Way Switching Dimmer
Insert Colour	Satin Steel
EAN13 Barcode	5017503249435
Commodity Code	85365015
Luckins TSI	385552972
Dimensions(Nominal)	Double: Height = 88.0mm Width = 144.5mm Depth = 5.0mm
Weight	269 GR
Switched Poles	Single
Current Rating	1.66 Amps per gang
Voltage	230V AC
Maximum Load	400W resistive per gang
Mains Frequency	50Hz
IP Rating	IP2XD
Contact Gap Minimum	N/A
Terminal Capacity 1	2x1mm ²
Terminal Capacity 2	2x1.5mm ²
Earth Terminal Capacity 1	5x1mm ²
Earth Terminal Capacity 2	4 x 1.5mm ²
Earth Terminal Capacity 3	3 x 2.5mm ²
Earth Terminal Capacity 4	1 x 4mm ² Multi-strand
Earth Terminal Capacity 5	1 x 6mm ²
Product Class 1	Face plate must be earthed
Ambient Operating Temperature	-5° to +40°C
Recommended Location	Internal Use Only
Maximum Installation Altitude	2000m
Standard/Approval	BS EN 60669-2-1

743X40

Hartland | HARTLAND RANGE | Resistive Leading Edge Push On/Off Rotary 2 Way Switching Dimmers

<p>Additional Notes</p>	<p>Tungsten filament GU10 lamps must be branded with a fuse base. When using mains voltage halogen lamps- dimmers should be de-rated by 25%. When dimming LED lamps de-rated by 75% - please contact our Technical for compatibility.</p>	
<p>All products listed conform to current British or European standard and the product information is correct at the time of going to press.</p>	<p>All accessories are manufactured under an accredited BS EN ISO 9001 : 2015 Quality Management System.</p>	<p>It is the policy of the company to improve products as part of our development programme. Therefore, we reserve the right to alter designs and dimensions without prior notice.</p>
<p>Illustrations and diagrams are reproduced within the limitations of reproduction and printing process and are not binding.</p>	<p>Due to manufacturing processes we cannot guarantee an exact colour match and shadings of of certain finishes.</p>	<p>Correct as at 18 August 2021 08:30 AM E&OE</p>
<p>R Hamilton & Co Ltd, Unit 10 Carrick Business Centre, 4-5 Bonville Road, Brislington, Bristol, BS4 5NZ T: +44 (0)1747 860088 F: +44 (0)1179 710414 E: info@hamilton-litestat.com www.hamilton-litestat.com Registered Office 1 Rushmills, Bedford Road, Northampton NN4 7YB Registered in London No. 941624 VAT Registration No. 222 6607 84</p>		  <p>Listed in  LUCKINS</p>    <p>CEC No. 1981138</p>
<p>743X40 - Hartland Satin Steel 3x400W Resistive Leading Edge Push On-Off Rotary 2 Way Switching Dimmers Satin Steel</p>		