

# KEWTECH

EZYPAT / EZYPAT+ / SMARTPAT

PORTABLE APPLIANCE TESTER

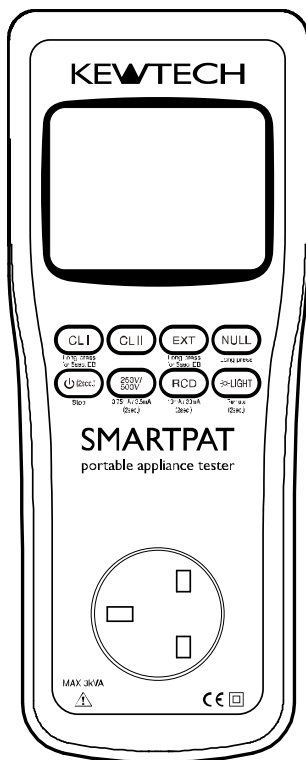

INSTRUCTION MANUAL

---

---

## CONTENTS

---

1. Safe testing .....	2
2. Product summary and explanation .....	5
2.1 Product summary .....	5
2.2 Test Function .....	5
2.3 Features .....	5
2.4 Testers layout .....	6
2.4.1 Function Switches .....	6
2.4.2 LCD indications .....	8
2.4.3 Connector .....	10
2.5 Accessories .....	11
3. Specification .....	12
3.1 General specification, measuring range and accuracy .....	12
3.3 Threshold and display .....	15
4. Preparation before a measurement .....	17
4.1 Visual inspection .....	17
4.2 Battery Voltage Check .....	17
4.3 Setting .....	17
4.3.1 Null setting .....	17
4.3.2 Voltage setting for insulation resistance measurement.....	18
(How to change between 250V and 500V) .....	18
4.3.3 Criteria setting for CL I leakage current test .....	18
5. Measuring method .....	20
5.1 Class I Test .....	20
5.3 Class II Test .....	25
5.3 Extension Leads Test .....	30
5.4 RCD TEST .....	33
6. Remote testing (SMART PAT) .....	37
7. Backlight .....	38
8. Battery / Fuse replacement.....	38
8.1 Battery Replacement.....	38
8.2 Fuse Replacement .....	39
9. Maintenance .....	39

---

## 1. Safe testing

---

Electricity is dangerous and can cause injury and death. Always treat it with the greatest of respect and care. If you are not quite sure how to proceed, then stop, take advice from a qualified person.

This instruction manual contains warning and safety rules which must be observed by the user to ensure safe operation of the Tester and retain it in safe condition. Therefore, read through these operating instructions before using the Tester.

### **IMPORTANT:**

The Tester must only be used by a competent and trained person and operated in strict accordance with these instructions.

KEWTECH will not accept liability for any damage or injury caused by misuse or non-compliance with the instructions or with the safety procedures.

It is essential to read and to understand the safety rules contained in these instructions and with the safety procedures.

The symbol  indicated on the Tester means that the user must refer to the related sections in the manual for safe operation of the Tester.

Be sure to carefully read instructions following each symbol  in this manual.

 **DANGER** : is reserved for conditions and actions that are likely to cause serious or fatal injury.

 **WARNING**: is reserved for conditions and actions that can cause serious or fatal injury.

 **CAUTION** : is reserved for conditions and actions that can cause injury or instrument damage.

### **DANGER**

- The Tester can be connected only to the commercial power of 100V – 253V, 50Hz.
- For safety reasons, only use the Test Leads designed to be used with this Tester and recommended by KEWTECH.
- Use only grounded mains outlets to supply the Tester.
- Do not touch the device under test whilst testing is in progress.

 **DANGER**

- Since a high voltage of 500V is being output continuously, when measuring insulation resistance, the user may get an electrical shock. Any capacitors in the appliance under test may become charged during testing and may contain hazardous voltages do not touch them.
- When testing, always be sure to keep your fingers behind the safety protective finger guard on the test leads.
- Disconnect the Tester from the power supply when measurement is finished.
- Do not leave the Tester with connected to the power supply.

 **WARNING**

- Never open the instrument case – because dangerous voltages are present. Only fully trained and competent electrical engineers should open the case.
- If abnormal conditions of any sort are noted (such as a faulty display, unexpected readings, broken case, cracked test leads, etc.) do not use the Tester and return it to your distributor for inspection and repair.
- Never attempt to use the Tester if the Tester or your hands are wet.

 **CAUTION**

- When using Test Leads with the crocodile clip, be sure to check the crocodile clip is firmly connected to the metal part of the device under test. Otherwise, inaccurate measurements or arcing at the contacts may occur.
- The rated measuring voltage for the insulation test is 500V. DC. If this voltage seems too high for the appliance under test contact the appliance manufacturer for advice. The IEE Code of Practice allows for a touch current test where an insulation test cannot be carried out.
- When testing a faulty appliance, it may trip the circuit breaker of main power supply during test and may cause interruption of service. Be careful when the same main power supply is used for PCs.
- We are not liable for loss of data on PC during testing with The Tester. The appliance under test is powered on during most tests, but please turn it to the OFF position after testing.
- Use a very slightly damp cloth for cleaning the Tester. Do not use abrasives or solvents.

## Measurement Category

To ensure safe operation of measuring instruments, IEC 61010 establishes safety standards for various electrical environments, categorized as O to CAT IV, and called measurement categories. Higher-numbered categories correspond to electrical environments with greater momentary energy, so a measuring instrument designed for CAT III environments can endure greater momentary energy than one designed for CAT II.

- O : Circuits which are not directly connected to the mains power supply.
- CAT II : Electrical circuits of equipment connected to an AC electrical outlet by a power cord.
- CAT III : Primary electrical circuits of the equipment connected directly to the distribution panel, and feeders from the distribution panel to outlets.
- CAT IV : The circuit from the service drop to the service entrance, and to the power meter and primary over-current protection device (distribution panel).

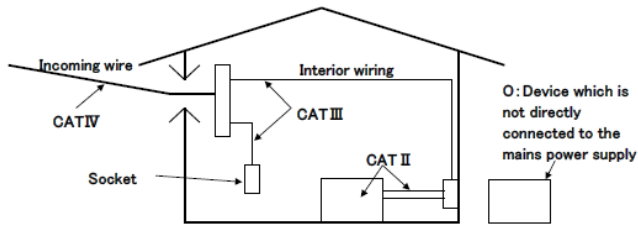

---

## 2. Product summary and explanation

---

### 2.1 Product summary

EZYPAT / EZYPAT+ / SMARTPAT (Tester) is a hand-held portable appliance tester and can test electrical safety of **Class I and Class II appliances**. **The Tester performs test and indicates PASS/ FAIL result complying with the criteria of judgement defined in The IEE Code of Practice for In-service Inspection and Testing of Electrical Equipment: 2003.**

As a guide, the IEC standard defines these two categories as follows:

Class I : Appliances which have a functional insulation throughout and an earth connected case. These are often described as earthed appliances.

Class II : Appliances which have both functional and additional insulation where any metal parts cannot become “Live” under fault conditions.

### 2.2 Test Function

Available functions vary depending on models.

Function		EZYPAT	EZYPAT+	SMARTPAT	
C L 1	Protective conductor resistance test (Test current 200mA DC nominal)	✓	✓	✓	
	C L 2	Insulation test (250V or 500V)	✓	✓	✓
	Substitute leakage current test	✓	✓	✓	
	Run leakage current test		✓	✓	
	Load current		✓	✓	
Extension Lead test		✓	✓	✓	
RCD Test				✓	
Remote function				✓	





### 2.3 Features

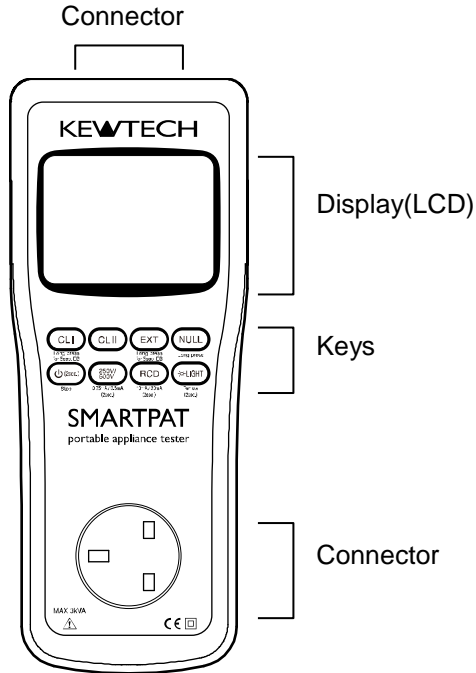

- Check for whether the appliance is switched ON.
- Selection for 250V or 500V on the insulation resistance test.
- Null function for the protective conductor resistance test.
- Auto-testing & PASS/ FAIL indication with backlight
- Auto-power-off
- Remote testing (SMARTPAT only)

## 2.4 Tester layout



### 2.4.1 Function Switches

Switch		Details
	CLI switch	Short press: Starts CLI test. (Continuity test: 1 sec.) Long press: Starts CLI test. (Continuity test: 5 sec.)
	CLII switch	Starts CLII test.
	Extension switch	Short press: Starts Extension lead test. (Cont. test: 1 sec.) Long press: Starts Extension lead test. (Cont. test: 5 sec.)
	NULL switch	Long press (at least 2 sec.): Performs NULL.

Switch		Details
	Power switch	Short press: Works as ESC switch. Returns to the stand-by screen when a test is halted by "FAIL" result. Long press: Turns on/ off the Tester.
	250V /500V	Short press: Switches output voltage for insulation resistance test between 250 V and 500 V. (Default setting: 250 V) Long press: Switches threshold current for CL I leakage current test between 0.75 mA and 3.5 mA. (Default setting: 0.75 mA)
	Light switch	Short press: Turns on/ off LCD backlight. Long press: Enters into remote mode.

#### SMART PAT only

	RCD switch	Switches to RCD stand-by screen. Another press on the stand-by screen starts RCD test. Long press on the screen switches test current between 10 mA and 30 mA. (Default setting: 30 mA)
-----------------------------------------------------------------------------------	------------	-----------------------------------------------------------------------------------------------------------------------------------------------------------------------------------------



## 2.4.2 LCD indications

<All symbols to be displayed on the LCD>

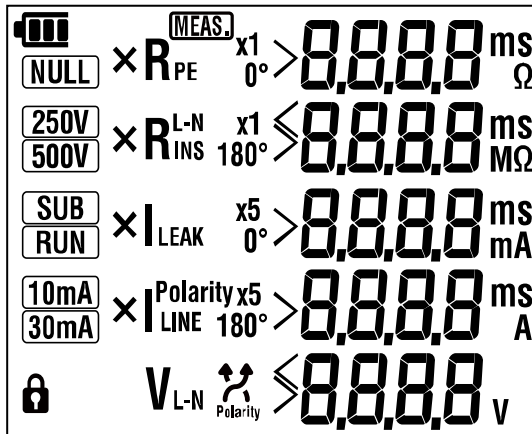

Display symbols

<b>NULL</b>	NULL value has been set.
<b>250V</b> <b>500V</b>	Rated voltage for insulation resistance test
<b>SUB</b> <b>RUN</b>	SUB: Substitute leakage current RUN: Leakage current test under actual working condition
<b>10mA</b> <b>30mA</b>	Rated current for RCD test
<b>MEAS.</b>	Measurement in process
	Switches are locked and Tester is in remote test mode. (The Tester is being controlled via a tablet device.)
<b>R<sub>PE</sub></b>	Protective conductor resistance
<b>R<sub>INS</sub></b>	Insulation resistance
<b>R<sub>INS</sub><sup>L-N</sup></b>	Insulation resistance between L-N (Extension Lead Test)
<b>I<sub>LEAK</sub></b>	Leakage current
<b>I<sub>LINE</sub></b>	Load current
<b>V<sub>L-N</sub></b>	Mains voltage
<b>Polarity</b>	Polarity test result
<b>X</b>	Indicates items failed the test.

x1 0° x1 180° x5 0° x5 180°	RCD test range
OFF?	Prompts to check and turn on a DUT.
 Polarity	Incorrect connection
Good	Indicates the resistance between L-L (N-N) is less than 10 Ω and polarity is correct.
OPEN	Open circuit warning –resistance between L-L (N-N) is 10 Ω or higher at polarity test.
Cross	Crossed L-N polarity warning - resistance between L-N (N-L) is 10 Ω or lower at polarity test.
< 0.10 MΩ	Short-circuited L-N warning – resistance between L-N is 100 kΩ or lower at insulation test. (Extension Lead Test)
UFV	Fault voltage of 50 V or higher is detected at RCD test.
PASS	Test result is “PASS”.
FAIL	Test result is “FAIL”.
no	RCD tripped at fault current detection.
EA6L	Indicates the measured protective conductor resistance is between 0.11 and 0.88 Ω.

### 2.4.3 Connector

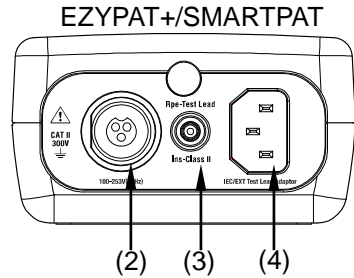
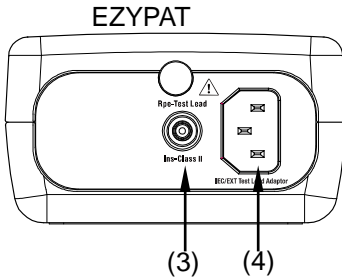
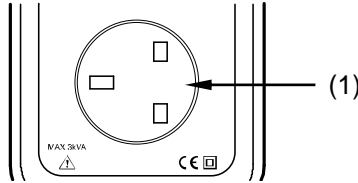

(1)	Test socket	Insert the mains plug of DUT to this socket for the polarity test of protective conductor resistance, insulation resistance and leakage current test.
(2)	Terminal for mains lead	This terminal is connected to a mains supply via EZYMAIN.
(3)	PE-probe terminal	Connect the Test Lead with alligator test clip to this terminal for the measurement of protective conductor resistance, and clip the metal parts of DUT with the alligator clip.
(4)	Terminal for Extension leads adaptor	It corresponds to L, N, E of test socket, and the extension leads adaptor connected with the cord reel to be plugged to it.

## 2.5 Accessories

### (1) Mains lead EZYMAIN (EZYPAT+/SMARTPAT)

This mains lead can be connected to the mains supply so that the Tester supply power to the DUT.

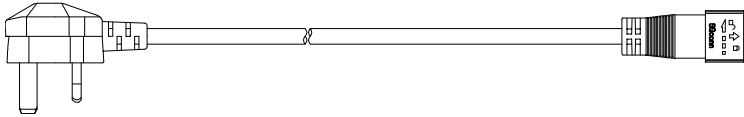

(2) Test Lead with safety crocodile clip (MODEL7208) and Probe with Blade type Prod(MODEL7168). The probe and crocodile clip are interchangeable. Please use it according to a measurement use.

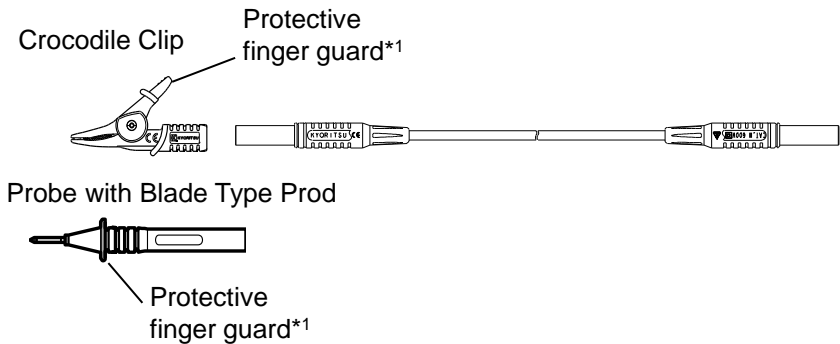

\*1 Protective finger guard is a part providing protection against electrical shock and ensuring the minimum required air and creepage distances.

### (3) Extension leads adaptor EZYEXT

This is for connecting the Tester and an extension lead (cord reel).



### (4) Soft case EZYBAG

### (5) Six AA alkaline batteries (LR6)

### (6) Instruction manual

### 3. Specification

#### 3.1 General specification, measuring range and accuracy

Mains voltage indication: available on EZYPAT+ and SMARTPAT only

Display range	30 - 270 V
Hi/ Lo indication	< 30 V: No voltage indication > 270 V: 270 V
Resolution	1 V
Accuracy	±5 V

\* Voltage between L-N of mains lead terminal is measured and displayed at voltage test.

#### Protective conductor resistance test

Measuring range	0.00 - 20.00 Ω (NULL value included.)*
Over-range indication	> 20.00 Ω
Resolution	0.01Ω
Open-circuit voltage	5 V ±0.4 V DC
Measuring current	200 mA DC (nominal value)
Accuracy	±3%rdg ±5dgt

\* Resistances exceeding 3 Ω cannot be canceled by NULL function.

#### Insulation resistance test

Rated voltage	250V	500V
Measuring range	0.00 - 20.00 MΩ	
Over-range indication	> 20.00 MΩ	
Resolution	0.01 MΩ	
No-load voltage	250 V DC +20%, -0%	500 V DC +20%, -0%
Short-circuit current	1.5 mA DC or less	
Rated current	1 -1.2 mA with a load of 0.25 MΩ	1 to 1.2 mA with a load of 0.5 MΩ
Accuracy	±2%rdg±3dgt	

Leakage current test under actual working condition: EZYPAT+ and SMARTPAT (Load current is also measured.)

Item	Load current	Leakage current
Mains voltage range	100 - 253 V/ 50 Hz	
Measuring range	0.10 - 13.00 A rms	0.10 - 20.00 mA rms
Display range	0.00 - 13.00 A	0.00 - 20.00 mA
Over-range indication	> 13.00 A	> 20.00 mA
Resolution	0.01A	0.01mA
Accuracy	$\pm 10\% \text{rdg} \pm 5 \text{dgt}$	$\pm 3\% \text{rdg} \pm 5 \text{dgt}$
Max. rating	3 kVA max./ 15 sec. continuous	---

\*If 100 V or higher voltage is being applied to, the Tester automatically performs leakage current test under actual working condition.

Substitute leakage current test

Measuring range	0.10 - 12.00 mA rms
Over-range indication	> 12.00 mA
Resolution	0.01mA
Open-circuit voltage/ Freq.	30 V $\pm 5$ V rms / 50 Hz $\pm 5\%$
Measuring current	1.2 mA AC $\pm 0.5$ mA (when measuring 12.00 mA)
Accuracy	$\pm 3\% \text{rdg} \pm 5 \text{dgt}$

Insulation test between L-N at Extension Lead Test

Open-circuit voltage	4.5 V $\pm 0.5$ V DC
Criteria of judgement	100 k $\Omega$ $\pm 20$ k $\Omega$ or less: LCD shows "<0.10 M $\Omega$ " and the measurement is halted.

RCD test: available with SMARTPAT only

Four tests with the pre-set rated current are performed in the following sequence:

$\times 1(0^\circ) \rightarrow \times 1(180^\circ) \rightarrow \times 5(0^\circ) \rightarrow \times 5(180^\circ)$ .

Rated voltage	230 V - 15% to +10%/ 50Hz	
Rated current	10 mA/ 30 mA	
Function	$\times 1$	$\times 5$
Test duration	0.0 ms - 500.0 ms	0.0 ms - 40.0 ms
Energization	FS $\pm 3\%$	
Test current accuracy	2% - 8%	
Operating time accuracy	$\pm 2$ ms ( $\leq 40$ ms) $\pm 8$ ms ( $> 40$ ms)	

### 3.2 General specification





Reference conditions	Specifications are based on the following conditions, except where otherwise stated:- (1) Ambient temperature: 23±5°C (2) Relative humidity: 45 - 75% (3) Attitude: Horizontal (4) AC power supply: 230 V, 50Hz (EZY PAT+, SMARTPAT) (5) Altitude: 2000m or less
Battery type	Six size AA alkaline batteries (LR6)
Operating temperature and humidity range	0°C to +40°C, relative humidity: 85% or less (no condensation)
Storage temperature and humidity range	-20°C to +60°C, relative humidity: 85% or less (no condensation)
Rate voltage and frequency (EZY PAT+, SMARTPAT)	Rated voltage: 230 V +10%, -15% Rated frequency: 50 Hz
Maximum load current at test socket (EZY PAT+, SMARTPAT)	3 kVA (15sec.)
Outer dimension and weight	Outer dimension: 261(L) × 104 (W) × 57(D)mm Weight (Tester body only): EZY PAT: Approx. 860g EZY PAT+: Approx. 950g SMARTPAT: Approx. 970g
Auto power off	The Tester turns off automatically after 5 minutes.

#### Applicable standards:

Instrument operation	The IEE Code of Practice for In-service Inspection and Testing of Electrical Equipment
Safety	IEC/EN61010-1 CAT II 300V-instrument IEC/EN61010-2-030 IEC/EN61010-031 CAT III 600V (MODEL7208 / MODEL7168 )
EMC	EN61326-1, 2-2
Possible number of measurements where battery voltage is	Approx. 1400 times (CLI Rpe: 0 Ω, Rins: 1.1 MΩ)

within the effective range  
(measuring every 30 sec.)

### Symbols used on the Tester:

CAT II	Electrical circuits of equipment connected to an AC electrical outlet by a power cord.
	Double or reinforced insulation
	User must refer to the explanations in the instruction manual.
	Earth
	Crossed-out wheel bin symbol (according to WEEE Directive: 2002/96/EC) indicating that this electrical product may not be treated as household waste, but that it must be collected and treated separately.

### 3.3 Threshold and display

Function	Protective conductor resistance	Insulation resistance	Leakage current
Class I	RPE $0.1\Omega^{(*)1}$ $\leq$	RINS $\geq 1M\Omega$	ILEAK $\leq 0.75mA$ or ILEAK $\leq 3.75mA$
Class II	/	RINS $\geq 2M\Omega$	ILEAK $\leq 0.25mA$
Extension Lead	RPE $0.1\Omega^{(*)1}$ $\leq$	RINS $\geq 1M\Omega$	/

#### RCD<sup>(\*)2</sup>

RCD Type	x1	x5
Plug Top	200 ms or less	40 ms or less
Installation	300 ms or less	40 ms or less

(\*)1: Extension leads and appliances with long mains leads have a greater resistance allowance for earth continuity. Please refer to the Table 1 on next page.

(\*)2: Plug Top type RCD-based judgement.



Table 1:

Nominal Conductor csa – should be marked on flexible cable (mm <sup>2</sup> )	Length (m)	Resistance (at 20°) (Ω)	Max. carrying current (A)
0.5	1	0.04	3
	2	0.08	
	3	0.12	
	4	0.16	
0.75	1	0.025	6
	2	0.05	
	3	0.08	
	4	0.10	
	5	0.13	
1.0	1	0.02	10
	2	0.04	
	3	0.06	
	4	0.08	
	5	0.10	
1.25	1	0.015	13
	2	0.03	
	3	0.05	
	4	0.06	
	5	0.08	
1.5	1	0.01	15
	2	0.03	
	3	0.04	
	4	0.05	
	5	0.06	
2.5	1	0.01	20
	2	0.01	
	3	0.02	
	4	0.03	
	5	0.04	
4	1	0.00	25
	2	0.01	
	3	0.01	
	4	0.01	
	5	0.02	

Summary of flexible table resistance rounded to two decimal places\*

\*For flexible cables to BS 6500 or BS 6360

**Note:** Further information on protective conductor resistance and testing of portable appliances can be found in the Code of Practice for In-service Inspection and Testing of Electrical Equipment published by the IEE.

---

## 4. Preparation before a measurement

---

### 4.1 Visual inspection

Before starting a measurement, the user should undertake visual checks on the mains lead, case and that the correct type and rated fuse is fitted to the appliance under test. There should also be no evidence of damage of a nature that may impair the electrical safety of the appliance.

### 4.2 Battery Voltage Check

- (1) Insert batteries with reference to *7. Battery/ Fuse Replacement* in this manual.
- (2) Hold down Power switch 2 sec. to turn on the Tester.
- (3) Check the battery indicator displayed in the upper left corner of the LCD.  
If just the last one segment of the indicator remains, the battery voltage is extremely low. Refer to *7. Battery/ Fuse Replacement* and replace batteries to perform further measurements.

If an empty battery indicator is displayed, the battery voltage is lower than the working voltage limit. Replace batteries immediately to keep accurate measurement.

Battery recommendation:

Use of alkaline battery is recommended. Use of other type of batteries may cause improper indication of battery level.

### 4.3 Setting

#### 4.3.1 Null setting

The IEE Code of Practice pass level for Protective conductor resistance is 0.1  $\Omega$ , which is a low value. So even the resistance of Test Leads will affect the measurement result.

The Tester can cancel the resistance of test lead by pressing **NULL**. The procedure of Null setting is shown below. The Null function is held in memory even when the Tester is turned off, so there's no need to Null the lead resistance every time. However, when replacing fuses or test leads, it is recommended to do a Null setting again.

Note:

Null setting is possible at both Class I Test and Extension Lead Test. However, only one Null value can be held in memory. For example, when the Null setting is carried out at Class I Test, the set value will also be used for Extension Lead Test (unless it is reset).

- (1) Insert Test Lead with probe (MODEL7208) into the Earth terminal of the Tester, and contact the tip of the Test Lead with the earth contacts of the socket on the Tester.
- (2) Hold down NULL switch at least 2 sec. on any screen.
- (3) The screen switches to NULL screen, and NULL measurement starts. The LCD shows blinking “MEAS” mark and measured value during a measurement. The measured value is saved and subtracted from the further measured values.

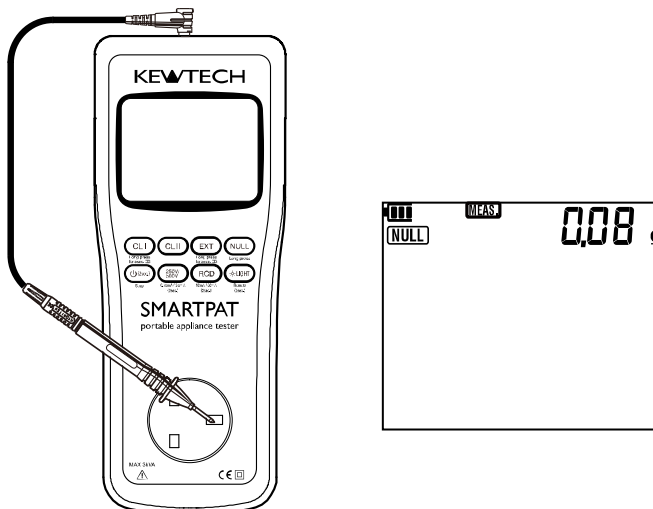

- (4) If the measured value is less than 3 Ω, previous NULL value is cleared and a new value is saved. When 3 Ω or higher is measured, previous NULL value is just cleared (NULL mark disappears).

### 4.3.2 Voltage setting for insulation resistance measurement (How to change between 250V and 500V)

Two difference rated voltages, 250 V and 500 V, are available for insulation resistance test. Press 250V/500V switch on the stand-by screen or while measured result is being displayed at CL I/ CL II/ Extension lead test. Default setting is 250 V.

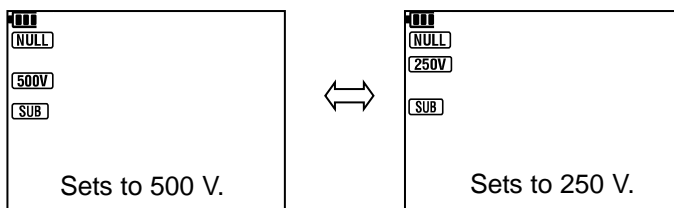

### 4.3.3 Criteria setting for CL I leakage current test

Either 0.75 mA or 3.5 mA can be set as threshold value for CL I leakage current test. Long press of 250V/500V switch on the stand-by screen or while measured result is being displayed at CL I/ CL II/ Extension lead test changes 0.75 mA and 3.5 mA. Default setting is 0.75 mA.

The *Code of Practice for In-service Inspection and Testing of Electrical Equipment* specifies 0.75 mA for portable or hand-held type Class I equipment and Class I heating devices and 3.5 mA for the other Class I equipment.

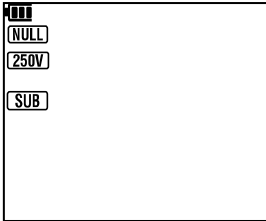

Threshold setting:  
0.75 mA

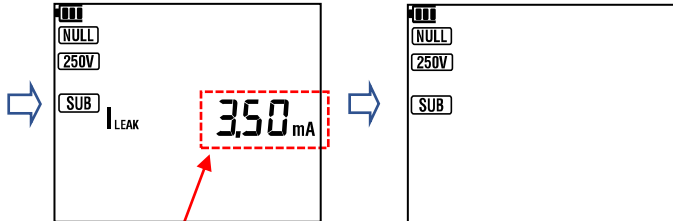

Blinking 3.50 mA is displayed (2 sec.), and then the screen returns to the stand-by screen. Now current of 3.5 mA is set.

---

## 5. Measuring method

---

### 5.1 Class I Test

The purpose of the test carried out for Class I appliances is to check the resistance of earth continuity from exposed metal parts and the plug is below a certain level and the insulation resistance between live and neutral connected together and earth is  $1M\Omega$  or more.

The Tester provides two different measurement methods to measure leakage current flowing on the earth terminal or exposed metal parts of Class I appliance. One is “RUN leakage current” test with the Tester connected to an outlet, and another is “SUBSTITUTE leakage current (SUB leak current)” test without connecting the Tester to an outlet.

To perform Class I test, connect the mains plug of the appliance to the test socket (1) described in clause 2.4.3. Connector and the PE probe to terminal (3). To perform RUN leak test, connect Mains lead EZYMAIN to Main cord terminal (2). Use the following setups, depending upon the type of appliance.

While the Tester is supplied power via Mains lead EZYMAIN, RUN leak test is automatically performed. If the EZYMAIN cord is not connected and used, the Tester performs SUB leak test.

Connect to exposed metal parts but not rotating parts or heating elements.

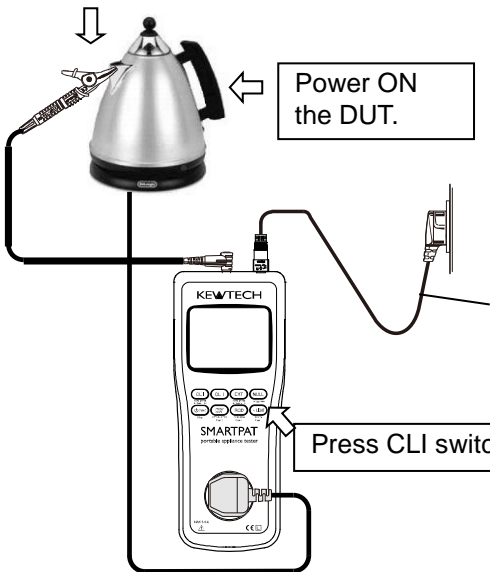

Power ON the DUT.

RUN leak test:  
Connect Tester to outlet  
SUB leak test:  
No need to connect Tester to outlet.

Press CLI switch for Class I test.

CL I Test Detail

1. Continuity test	Earth continuity test between the exposed metal parts and plug
2. Insulation test	Between LINE, NEUTRAL and EARTH.
3. Leakage current test	RUN Leak test: Connect Tester to outlet: (Load current is also measured.)  SUB leak test: Not connect Tester to outlet

# CL I Test Flow

Press **0 (Halt)** to halt a measurement in process.

Tester performs next test when CL I switch is pressed while a test is halted with "FAIL" indication.

Stand-by

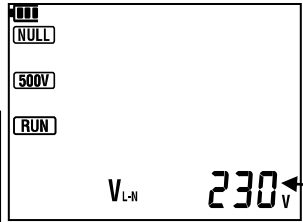

Voltage value is displayed while the Tester is connected to an outlet.

CL I

Press CL I to start a test.  
Short press: 1 sec of continuity test  
Long press: 5 sec of continuity test

Continuity test

1. Continuity test

$R_{pe} > 0.11 \Omega = \text{PASS}$

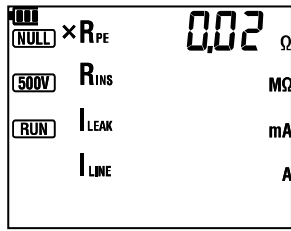

$0.11 - 0.88 \Omega = tAbL$

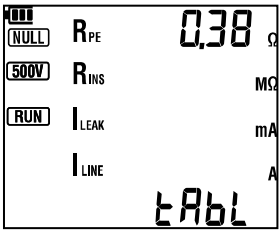

$R_{pe} > 0.88 \Omega = \text{FAIL}$

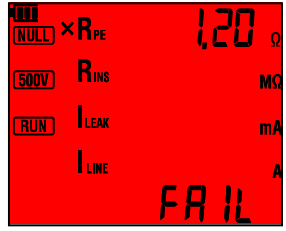

CL I

Press to proceed to the next; continuity test is regarded as PASS.

DUT ON Check

DUT is OFF.

DUT is ON.

2. Insulation resistance test

Insulation resistance test

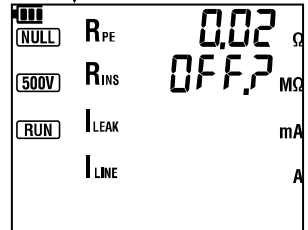

DUT is powered on, or CL I is pressed.

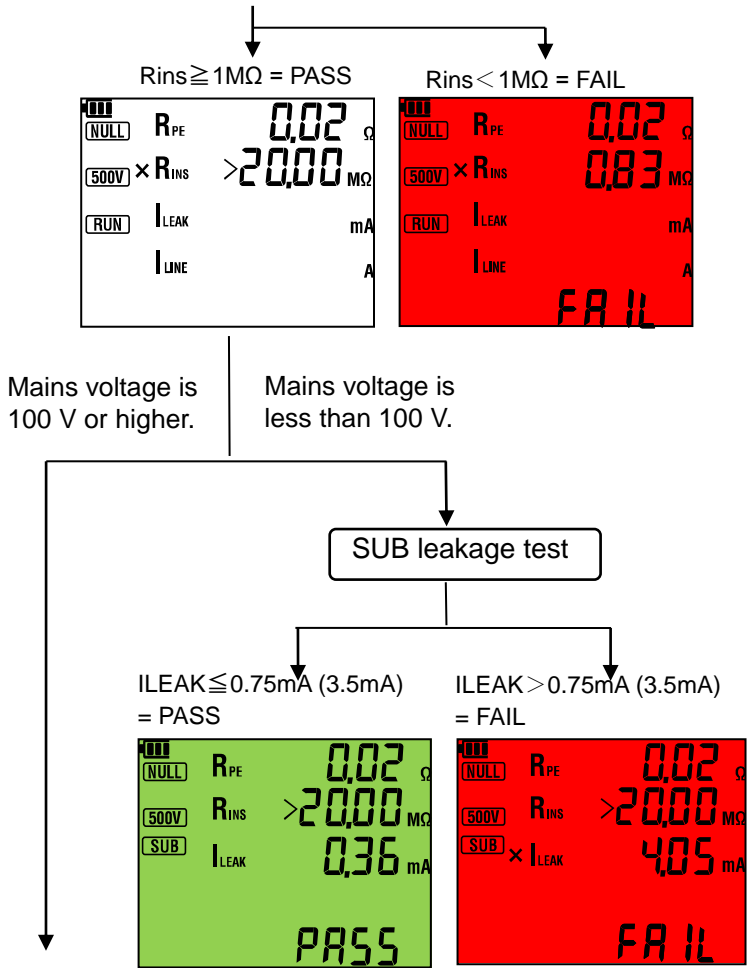

Check screen for RUN leakage test.  
Buzzer sounds and blue backlight blinks.

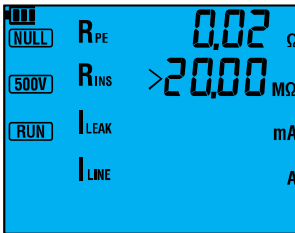



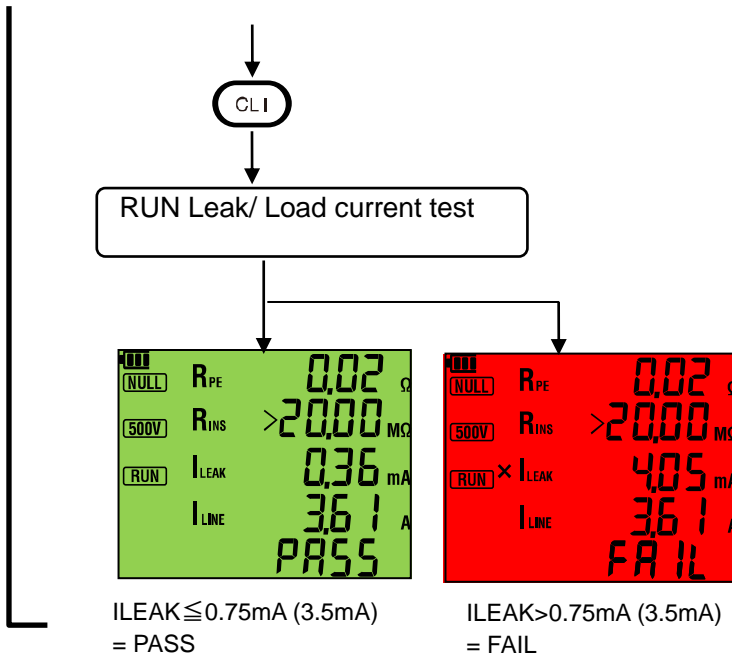

Note 1: The IEE Code of Practice states that the maximum resistance should be no greater than 0.1 Ohms + the resistance of the mains cable. Therefore, if the appliance has a long mains lead then the allowable resistance can be higher than the pre-programmed 0.1  $\Omega$ .

### ⚠ WARNING

- When conducting a leakage test the appliance will automatically power on and will operate in its normal manner. It is imperative that the appliance is secured safely before the test is carried out. Extra care needs to be taken with appliances which have heating elements and rotating parts.
- Firmly insert the plug of the appliance to the socket of the Tester. Plugs may get hot if Leakage current test is performed with improper connection.
- Do not connect/remove the plugs during Leakage current test. It may cause a reading error.
- Do not use the Tester on the device which has a power consumption of 3 kVA or more.

### CAUTION

- Where DUT ON Check function detects that DUT is off, blinking "OFF?" appears in the LCD and the test is stopped. Turn on the DUT; then the Tester automatically resumes the test. Depending on DUTs, even they are turned on, blinking "OFF?" warning sometimes doesn't disappear and the Tester cannot continue the test automatically. In such a case, press CL I switch to continue the test.
- Follow the procedure described in 4.3.1 and undertake the NULL setting before a measurement.
- The crocodile clip must make good contact with the enclosure of the appliance.
- Do not touch the appliance under test whilst testing is in progress. Since a high voltage of 250V/500V will be present and the user may get an electrical shock.
- When the terminal is open or the resistance value exceeds the measuring range, ">" (over range display) appears on the LCD.

### 5.3 Class II Test

The Class II appliances have the indication of "DOUBLE INSULATION" or the  symbol.

Class II test is performed to confirm insulation resistance and leakage current of the appliance are within the allowable range specified in the related standard.

The Tester provides two different measurement methods to measure leakage current flowing on exposed metal parts of Class II appliance. One is "RUN leakage current" test with the Tester connected to an outlet, and another is "SUBSTITUTE leakage current (SUB leak current)" test without connecting the Tester to an outlet.

To perform Class II test, connect the mains plug of the appliance to the test socket (1) described in clause 2.4.3. Connector and the PE probe to terminal (3). To perform RUN leak test, connect Mains lead EZYMAIN to Main cord terminal (2). Use the following setups, depending upon the type of appliance.

While the Tester is supplied power via Mains lead EZYMAIN, RUN leak test is automatically performed. If the EZYMAIN cord is not connected and used, the Tester performs SUB leak test.

Connect to exposed metal parts but not rotating parts or heating elements.

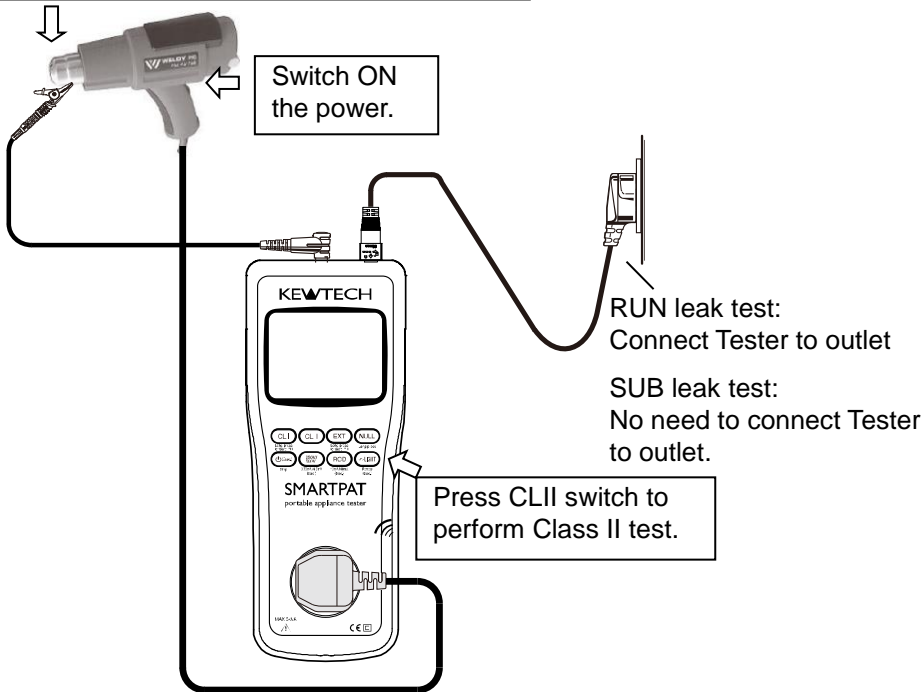

1. Insulation test	Between LINE, NEUTRAL and EARTH.
2. Leakage current test	<p>RUN Leak test: Connect Tester to outlet. (Load current is also measured.)</p> <p>SUB leak test: No need to connect Tester to outlet.</p>

# CL II Test Flow

Press **CL II** to halt a measurement in process.

Tester performs next test when CL II switch is pressed while a test is halted with "FAIL" indication.

## Stand-by state

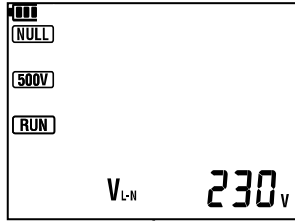

Voltage value is displayed while the Tester is connected to an outlet.



Connection Check

"CL I" is displayed if R<sub>pe</sub> terminal is integrated in the power cord of DUT.

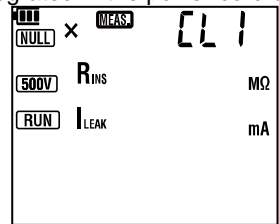

Press to proceed to the next; continuity test is regarded as PASS.



DUT ON Check

DUT is ON.

DUT is OFF.

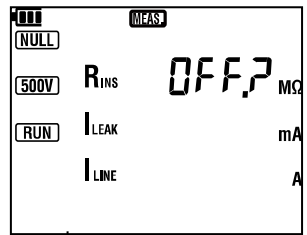

DUT is powered on, or CL2 is pressed.

Insulation resistance test

1. Insulation resistance test

Rins  $\geq 2 \text{ M}\Omega$  = PASS

Rins  $< 2 \text{ M}\Omega$  = FAIL

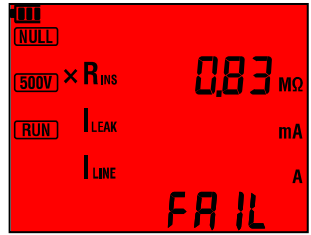
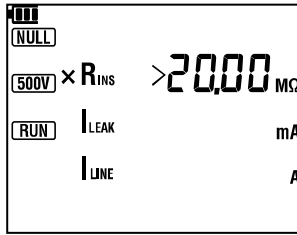

Mains voltage is 100 V or higher.

Mains voltage is less than 100 V.

SUB Leakage test

I<sub>LEAK</sub>  $\leq 0.25 \text{ mA}$  = PASS

I<sub>LEAK</sub>  $> 0.25 \text{ mA}$  = FAIL

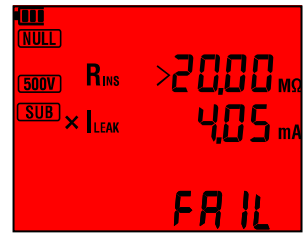
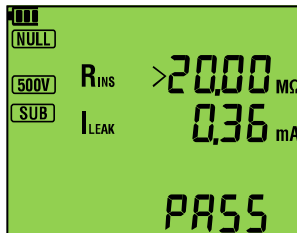

Check screen for RUN leakage test.  
Buzzer sounds and blue backlight blinks.

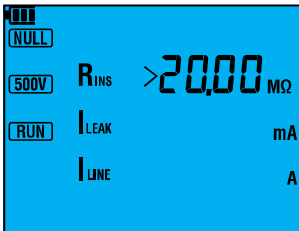

2. Leakage current test

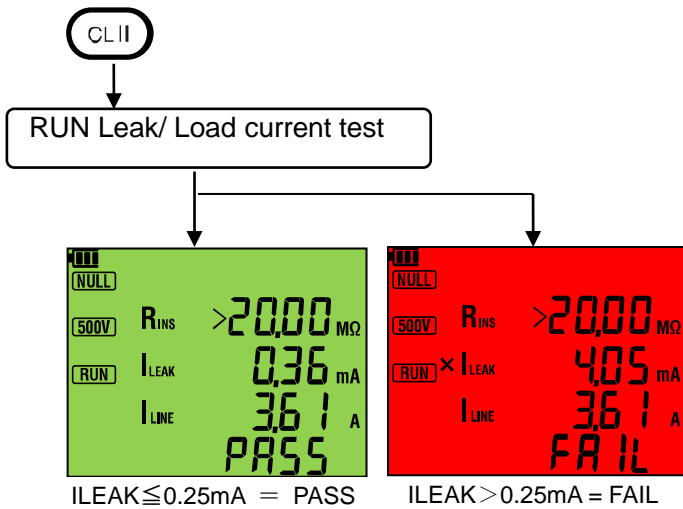

### ⚠ CAUTION

- Where DUT ON Check function detects the DUT is off, blinking "OFF?" appears in the LCD and the test is stopped. Turn on the DUT; then the Tester automatically resumes the test. Depending on DUTs, even they are turned on, blinking "OFF?" warning sometimes doesn't disappear and the Tester cannot continue the test automatically. In such a case, press CL II switch to continue the test.
- When the terminal is open or the resistance value exceeds the measuring range, ">" mark (over range display) appears on the LCD.
- Do not touch the appliance under test whilst testing is in progress. Since a high voltage of 250V or 500V will be present and the user may get an electrical shock.

### ⚠ WARNING

- When conducting a leakage test the appliance will automatically power on and will operate in its normal manner. It is imperative that the appliance is secured safely before the test is carried out. Extra care needs to be taken with appliances which have heating elements and rotating parts.
- Firmly insert the plug of the appliance to the socket of the Tester. Plugs may get hot if Leakage current test is performed with improper connection.
- Do not connect/remove the plugs during Leakage current test. It may cause a reading error.
- Do not use the Tester on the device which has a power consumption of 3 kVA or more.

### 5.3 Extension Leads Test

This test is for extension leads, and checks for;

- Protective conductor resistance between accessible conductive parts and connection of protective earth.
- Insulation resistance between L/N and PE.
- Polarity check of the Line and Neutral terminal of plug and socket.

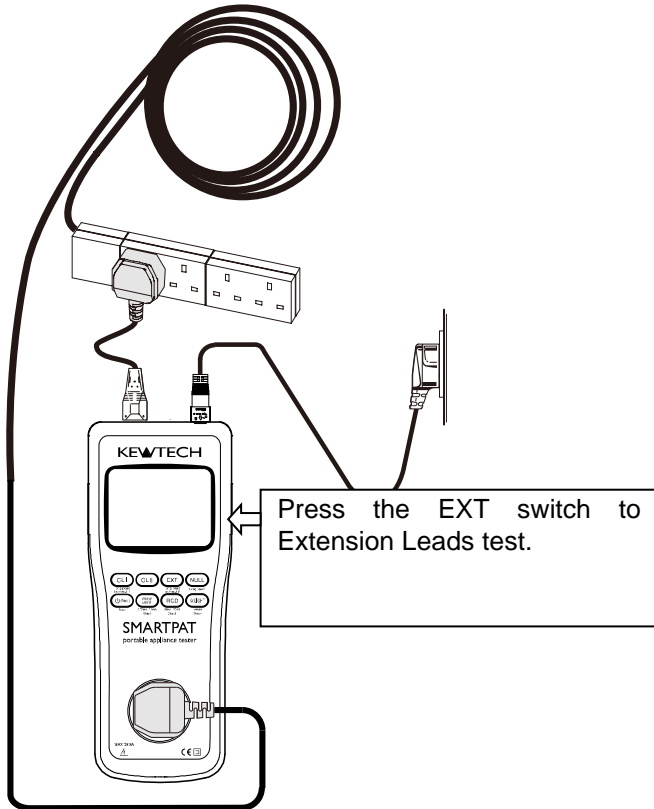

1. Continuity test	For PE terminal of Extension Leads
2. Insulation test	Between LINE, NEUTRAL and EARTH, and between LINE and NEUTRAL
3. Polarity check	For LINE and NEUTRAL

# Extension Lead test flow

Press  to halt a measurement in process.

Tester performs next test when EXT switch is pressed while a test is halted with "FAIL" indication.

## Stand-by

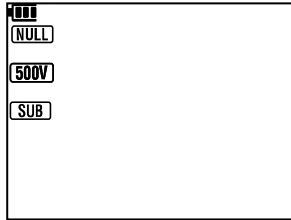

**EXT**

Press EXT to start a test.  
 Short press: 1 sec of continuity test  
 Long press: 5 sec of continuity test

## Continuity test

1. Continuity test

$R_{pe} \leq 0.10\Omega = \text{PASS}$

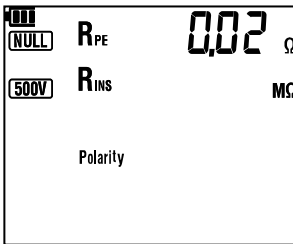

$0.11 - 0.88\Omega = \text{tAbL}$

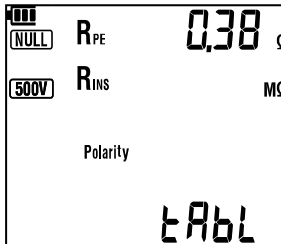

$R_{pe} > 0.88\Omega = \text{FAIL}$

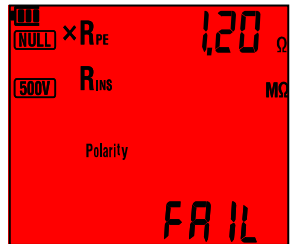

**EXT**

Press to proceed to the next; continuity test is regarded as PASS.

## Insulation resistance test between: (1) L&N - E, (2) L-N

2. Insulation resistance test

$L\&N-E \geq 1M\Omega = \text{PASS}$

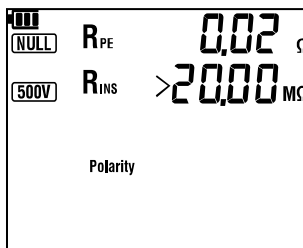

$L\&N-E < 1M\Omega = \text{FAIL}$

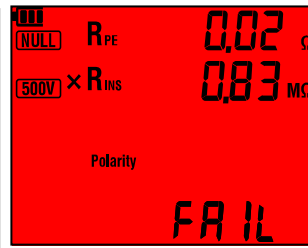

$L-N < 0.1M\Omega = \text{FAIL}$

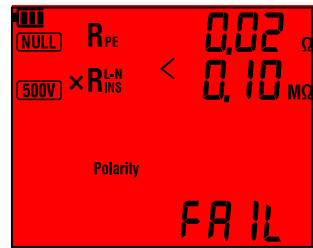



### 3. Polarity check

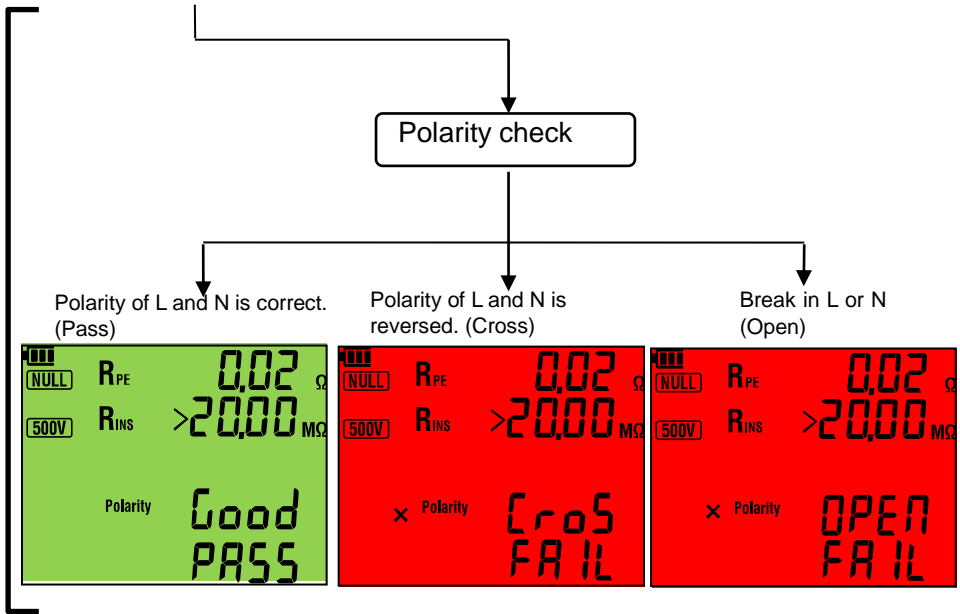

Note: The IEE Code of Practice states that the maximum resistance should be no greater than 0.1 Ohms + the resistance of the mains cable. Therefore, if the appliance has a long mains lead then the allowable resistance can be higher than the pre-programmed 0.1 $\Omega$ .

#### ⚠ CAUTION

- Follow the procedure described in 4.3.1 and do Null setting before a measurement, but use the short EZYEXT lead instead of the MODEL7208 test lead, by plugging the EZYEXT into the Extension Lead Adaptor terminal and the UK socket on the front of the unit.
- When the terminal is open or the resistance value exceeds the measuring range, “ > ” (over range display) appears on the LCD.
- Do not touch the device under test whilst testing is in progress. Since a high voltage of 250V or 500V will be present, the user may get an electrical shock.

## 5.4 RCD TEST

### (1) PRCD test

This test is to test and confirm a PRCD (Portable Residual Current Device) trips within the rated time by applying specified current. The Tester incorporates a circuit to test PRCD with Rated Tripping Current ( $I \Delta n$ ) of 10 mA or 30 mA. PRCD trip time is measured in sequence:  $\times 1(0^\circ) \rightarrow \times 1(180^\circ) \rightarrow \times 5(0^\circ) \rightarrow \times 5(180^\circ)$ . After each test, reset the tripped PRCD to proceed to the next test. PASS result is given where the PRCD tripped within the rated time through all the tests.

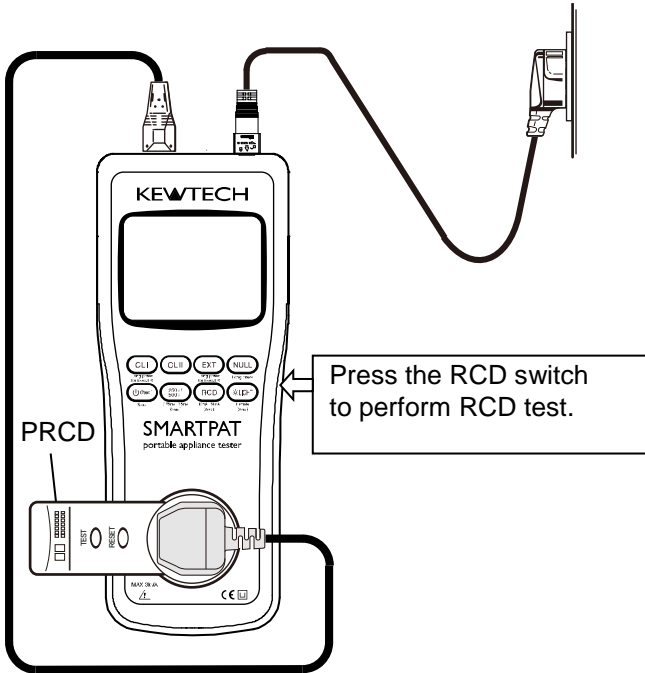

# RCD Test Flow

Press  to halt a measurement in process.

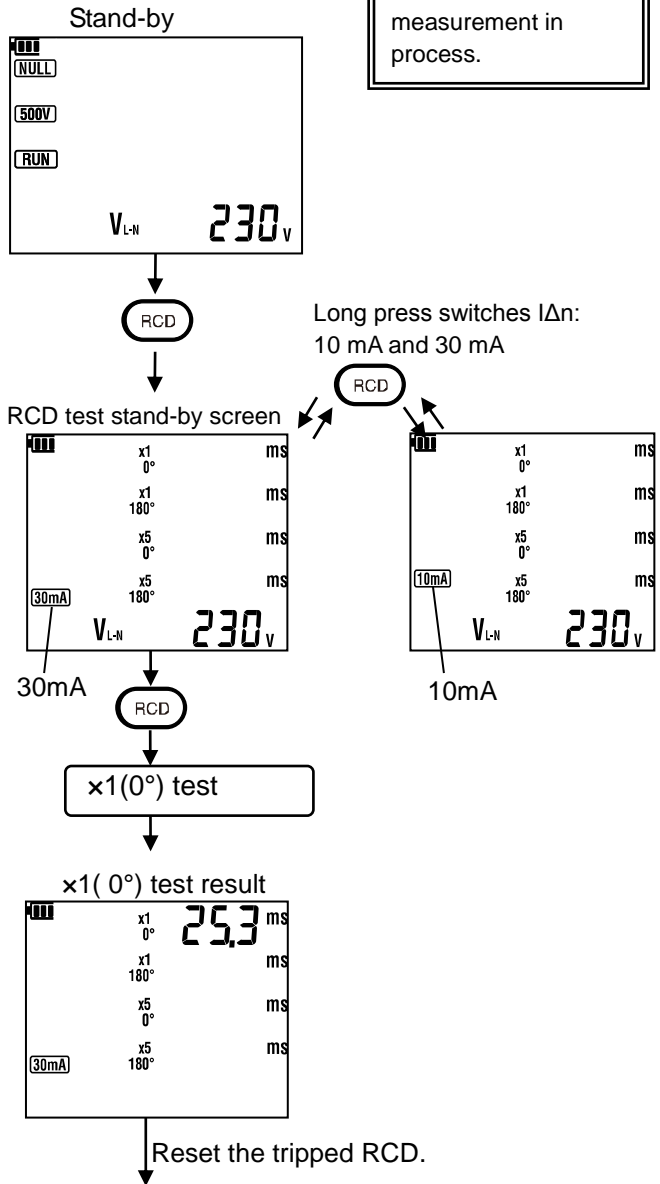

↓  
x1(180°) test

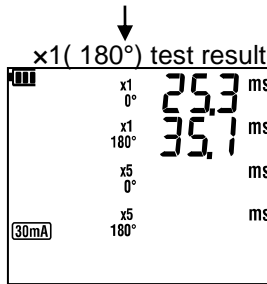

↓ Reset the tripped RCD.

x5(0°) test

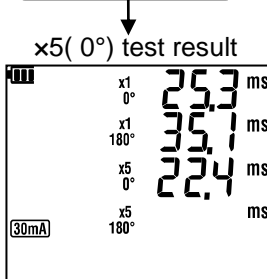

↓ Reset the tripped RCD.

x5(180°) test

Test results are all "PASS":

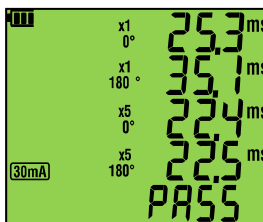

"PASS" is displayed.

If any one of test results is "FAIL":

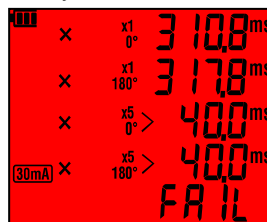

"FAIL" is displayed.



- Check the connection if **Polarity** symbol is displayed in the LCD. Connection may be incorrect and a test doesn't start even RCD switch is pressed.
- If " $I_{\Delta n}$ " setting is greater than the rated residual current of the RCD, the RCD will trip and "no" may be displayed on LCD.
- Special conditions of RCDs of a particular design, for example S- type, should be taken into consideration.

## (2) PRCD test via socket outlet

Make connection as the following illustration indicates when testing a PRCD connected to a socket outlet. For this test, use EZYEXT for connection.

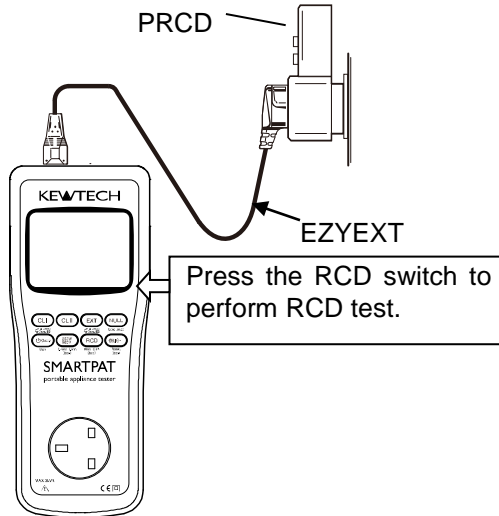

- If a fault voltage exceeds 50 V while applying a test current to test a built-in type RCD, the LCD shows "Uf. Hi" and the test is halted.
- If a voltage exists between the protective conductor and earth, it may influence the measurements.
- If a voltage exists between neutral and earth, it may influence the measurements, therefore, the connection between neutral point of the distribution system and earth should be checked before testing.
- The potential fields of other earthing installations may influence the measurement.
- The earth electrode resistance of a measuring circuit with a probe shall not exceed table 1.
- Equipment following the RCD, e.g. capacitors or rotating machinery, may cause a significant lengthening of the measured trip time.

---

## 6. Remote testing (SMART PAT)

---

SMARTPAT incorporates Wi-Fi communication function. Tablet devices that has a special application “SimplyPats” can remotely control SMARTPAT.

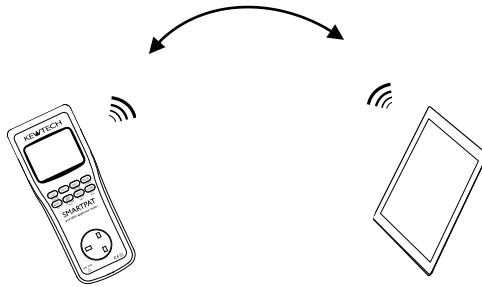

The special application “SimplyPats” can be downloaded from the internet site. (Internet access is required and charges may be incurred.) For further detail, please refer to Help for “SimplyPats”.

Remote settings:

To use the remote-control function of SMARTPAT, enable Wi-Fi function and remote mode.

Hold down the backlight switch at least 2 sec. to get the Tester into remote mode. The  symbol appears to indicate the remote mode is enabled. Hold down the backlight switch 2 sec. or longer to disable the remote mode.

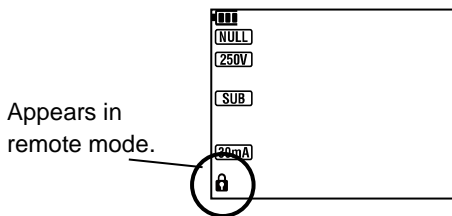

- Wi-Fi interface

- (1) Wireless protocol: IEEE802.11b/g/n
- (2) Frequency: 2.4 – 2.495 GHz

---

## 7. Backlight

---

Press the backlight switch to turn on the backlight. Press the switch again to turn off the backlight. The backlight automatically turns off if there is no activity for about 2 min.

---

## 8. Battery / Fuse replacement

---

 **DANGER**

Never open the Battery cover during a measurement. Dispose the used batteries according to the rules, which is defined by each community.

 **WARNING**

To avoid possible electric shock, remove test leads before opening the battery cover. After replacing batteries, be sure to tighten up the screws for battery cover.

 **CAUTION**

Do not mix new and old batteries. Install batteries in correct polarity as marked inside the battery compartment.

### 8.1 Battery Replacement

- (1) Disconnect the test probe from the Tester.
- (2) Open the battery cover by unscrewing the metal captive screw to reveal battery compartment.
- (3) Always replace all six batteries with new ones at the same time.  
“Six size AA alkaline batteries (LR6)”
- (4) Screw the battery cover back on before using the Tester.

## 8.2 Fuse Replacement

- (1) Disconnect the test probe from the Tester.
- (2) Unscrew the metal captive and open the battery compartment cover to replace the fuse.

Fuse type: 10A/250V(F)

Fast acting type ceramic fuse  $\Phi$  5 x 20mm.

- (3) Screw the battery cover back on before using the Tester.

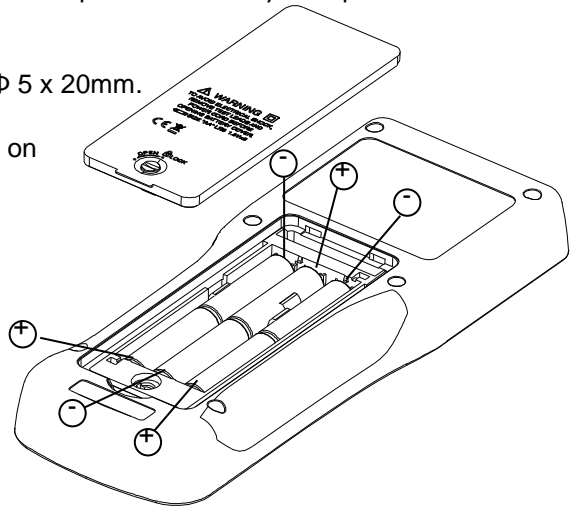
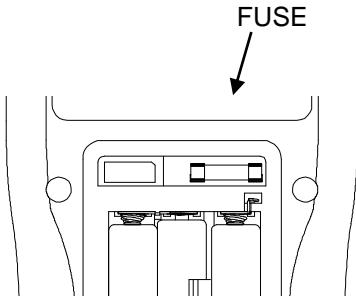

---

## 9. Maintenance

---

Use a very slightly damp cloth for cleaning the Tester. Do not use abrasives or solvents.



Kewtech Corporation Ltd.  
Midas House, Unit 2b  
Stones Courtyard  
High Street, Chesham  
Buckinghamshire HP5 1DE  
[www.kewtechcorp.com](http://www.kewtechcorp.com)

**92-2287**

**06-17**