

# **Premier Elite 8XP- W/32XP-W**

**Wireless Mesh Networking Expander**

**INS467-9**



***Texecom***

# Content

- 1.0 Premier Elite 8XP-W & 32XP-W** ..... 3
- 2.0 Ricochet V3.xx and above** ..... 4
  - 2.1 System Requirements ..... 6
  - 2.2 System Design Considerations ..... 6
- 3.0 Quick Start Guide** ..... 8
- 4.0 System Overview** ..... 9
  - 4.1 Mounting the Expander ..... 11
  - 4.2 Wiring ..... 12
  - 4.3 Selecting an Address ..... 12
  - 4.4 Ricochet Expander Addressing ..... 13
- 5.0 Programming** ..... 14
  - 5.1 Premier Elite™ V2.10 / 12/24/48/88/168 Ricochet Learn Menu ..... 15
  - 5.2 Auto Zone Type & Area ..... 17
  - 5.3 Deleting Devices ..... 17
  - 5.4 Summary of Keys used ..... 19
  - 5.5 Premier EliteV2.00 - V2.09 24/48/88/168 & 640 + Ricochet V2.xx ..... 19
  - 5.6 Premier Elite SmartKey™ ..... 22
  - 5.7 Premier 412/816 V9.5 &V11.10 & Later, Premier 832 2.5 &V4.10 & Later ..... 26
  - 5.8 Learning Devices directly to the 8XP-W & 32XP-W ..... 30
  - 5.9 Using the Engineers Keypad ..... 30
- 6.0 Ricochet Diagnostics** ..... 30
  - 6.1 Premier Elite 8XP-W & 32XP-W V3.XX ..... 30
  - 6.2 Premier elite V2.XX & later ..... 31
  - 6.3 Premier Elite V3.XX / ..... 36
- 7.0 Modes of Operation** ..... 36
  - 7.1 Commission Mode ..... 36
  - 7.2 Device Specific Functions ..... 37
  - 7.3 Walktest Mode ..... 38
- 8.0 System Attributes** ..... 39
  - 8.1 Polling ..... 39
  - 8.2 System Devices ..... 39
  - 8.3 Premier Elite SmartKey™ ..... 41
  - 8.4 Battery Considerations ..... 44
  - 8.5 Premier Elite 8XP-W & 32XP-W Power Loss ..... 44
- 9.0 Specifications** ..... 45
  - 9.1 Electrical ..... 45
  - 9.2 Physical ..... 45
  - 9.3 Wireless ..... 46
  - 9.4 Standards ..... 46
  - 9.5 Warranty ..... 47

# 1.0 Premier Elite 8XP-W & 32XP-W

Texecom has developed a new method of wireless security signalling based on the concept of mesh networking. Mesh-networking is the process whereby every single wireless device is capable of receiving and retransmitting any signal from any other wireless device on the network. The size, scalability and range of the entire system are extended as wireless signalling is no longer limited by point-to point communications. The range of a *Ricochet*® enabled wireless system is greater than previous systems, with multiple devices capable of relaying messages to and from even the most remote locations in a building. Each *Ricochet* enabled device provides signalling routes to and from control panels. If the wireless communication between devices weakens, the *Ricochet* network 'self-heals' and automatically re-routes communications via alternate *Ricochet* enabled devices. The reliability of the wireless system increases as more *Ricochet* devices are installed. **SignalSecurity**™ further enhances network reliability with each device already aware of the number of communication paths available to it.

The **8XP-W** & **32XP-W** expanders can be used on any premier control panel; however certain features and functions are dependent on the version of panel firmware as detailed in the table below. To determine the firmware version of your control panel press  /  4 on the keypad.

 *Firmware versions prior to those listed are **NOT** compatible.*

Control Panel	Premier 8 XP-W & 32XP-W	Legacy	Ricochet	Ricochet V2/V3.xx
Premier 412	1	V10.5 – V11.07	V11.10> & PV1.0>	←Ricochet Mode
Premier 816	1	V10.5 – V11.07	V11.10> & PV1.0>	←Ricochet Mode
Premier 816E	0	Not supported		
Premier 832	1	V3.5 – V4.07	V4.10> & PV1.0>	←Ricochet Mode
Premier 24	1	V7.00 – V8.23	V8.24>	←Ricochet Mode
Premier 48/88/168	1	V7.00 – V8.13	V8.15>	←Ricochet Mode
Premier 640	1	V7.00 – V8.15	Not Released	←Ricochet Mode
V1 Premier Elite 24/48/88/168 & 640	1	N/A	V1.00>	←Ricochet Mode
V2-V2.09 Premier Elite 24/48/88/168 & 640	See Section 3	N/A	V2.00>	V2.00>
** V2.10 > Premier Elite 12/24/48/88/168 & 640*	See Section 3	N/A	V2.10>	V2.10>
V4.00 > Premier Elite 12/24/48/88/168 & 640*	See Section 3	N/A	V3.00>	V3.00>

\*\* New dedicated *Ricochet* learn menu added. Existing methods of learning still exist.

## 2.0 Ricochet V3.xx and above

**Premier Elite Series™** control panels with V4.xx firmware now contains additional *Ricochet V3* capability. This new technology adds new features and functions for *Ricochet* enabled security systems.



**DO NOT mix V1 & V2/V3 expanders on the same Premier Elite panel**

### V3 Expander Diagnostics

V3 expanders have the ability to display diagnostic information about devices. Please [see chapter 6.0](#) for full details.

### V3 Expander & V4 Premier Elite Control Panels

- **Temperature Readings** are available from supported devices

- **Expanders** can be replaced without the need to relearn devices
  - This only applies if devices were originally learned to a V4 panel.

Panel flashing consequences				
Panel Version	Expander Version	Relearn devices if you replace the expander?	Relearn if you Flash Elite 24/48/88/168 & 640 to V4.X.X	Relearn if you Flash Elite 12-W/24-W & 48-W to V4.X.X
V2.X.X V3.X.X	All Versions	Yes	No	No
V4.X.X>	1.X.X 2.X.X	Yes	No	No
	3.0.6>	No	No	No

### V3 Multiple Expander Support

V2 introduced multiple expander support to the system allowing for greater flexibility in system design, and also taking wireless capability to new levels.

### Control Panel Capacity

The table below details the maximum number of expanders, devices and **Premier Elite SmartKey™** that may be used on the different control panels, other configurations may be possible by mixing **Premier Elite 32XP-W** & **Premier Elite 8XP-W**.

Panel	32XP-W			8XP-W		
	Expanders	Devices	Premier Elite SmartKey™	Expanders	Devices	Premier Elite SmartKey™
<b>Premier Elite 12-W &amp; Live™</b>	N/A	N/A	N/A	N/A	8	8
<b>Premier Elite 24™</b>	1	16	16	2	16	25
<b>Premier Elite 48™</b>	1	32	16	4	32	50
<b>Premier Elite 48-W™</b>	N/A	32	16	N/A	N/A	N/A
<b>Premier Elite 88™</b>	2	64	32	8	64	100
<b>Premier Elite 168™</b>	4	128	64	16	128	200
<b>Premier Elite 640™</b>	16	512	256	64	512	1000

 **Premier Elite 32XP-W** take 4 address slots on the network, **Premier Elite 8XP-W** take one address

## 2.1 System Requirements

To enable all of the advanced functionality and diagnostics capability for **Ricochet V3** the following are minimum requirements:-

- **Wintex™** Version 6.2 Build 4 or later
- **Ricochet Monitor™** 0.2.18.5.1 or later
- **Premier Elite™ Series** V4.xx or later
- **Premier Elite™ 32XP-W & 8-W** Expanders V3.xx or later



*Expander firmware version can be found on the round green sticker located on the RH side of the PCB.*

## 2.2 System Design Considerations

To ensure correct setup and operation of the Wireless Network it is important that the following procedures are used when learning and placing devices.

### Multiple Expander Systems

When using multiple expanders great care should be taken when designing the system. Each expander should be treated as its own wireless network; it is not possible for devices to hop from one wireless network to the other; it is also not possible for expanders to pass wireless signals from devices not assigned to them and nor can the expanders talk to each other.

### Learning Devices

All devices should be learnt **before** they are placed in their final location. The expander should be in commission mode, please [see chapter 7.1](#). This will ensure that they are registered on the receiver or control panel, and that Mesh Networks and routing are established correctly. Please refer to the relevant section in this document to Learn Devices to the system.

### Learning Premier Elite SmartKey™

**Premier Elite SmartKey™** should only be learned **AFTER** all devices and

expanders are in their final location, this is critical on larger systems where multiple expanders are being used

 *Devices should be at least 30cm's away but no further than 10m from the receiver when being learned.*

## **Placing Devices**

Once all of the devices have been learnt, they will need placing in their desired location, this should be done by installing devices closest to the expander first and then working outwards so that the last devices installed are those furthest away from the expander.

Make sure to install devices with the expander in Commission mode. [See chapter 7.1.](#)

Devices also have a commission mode which will indicate a secure and valid path of communication to the receiver. [See chapter 7.1.](#)

 *You should wait at least 20 minutes after installing the last device to make sure routing has been correctly established between all system devices.*

 *For maximum reliability and system integrity avoid long and thin set-ups. Do not mount devices on or near metal. Keep devices away from mains electricity supplies.*

 *Devices are capable of hopping through up to two other devices, or a maximum of three hops.*

# 3.0 Quick Start Guide

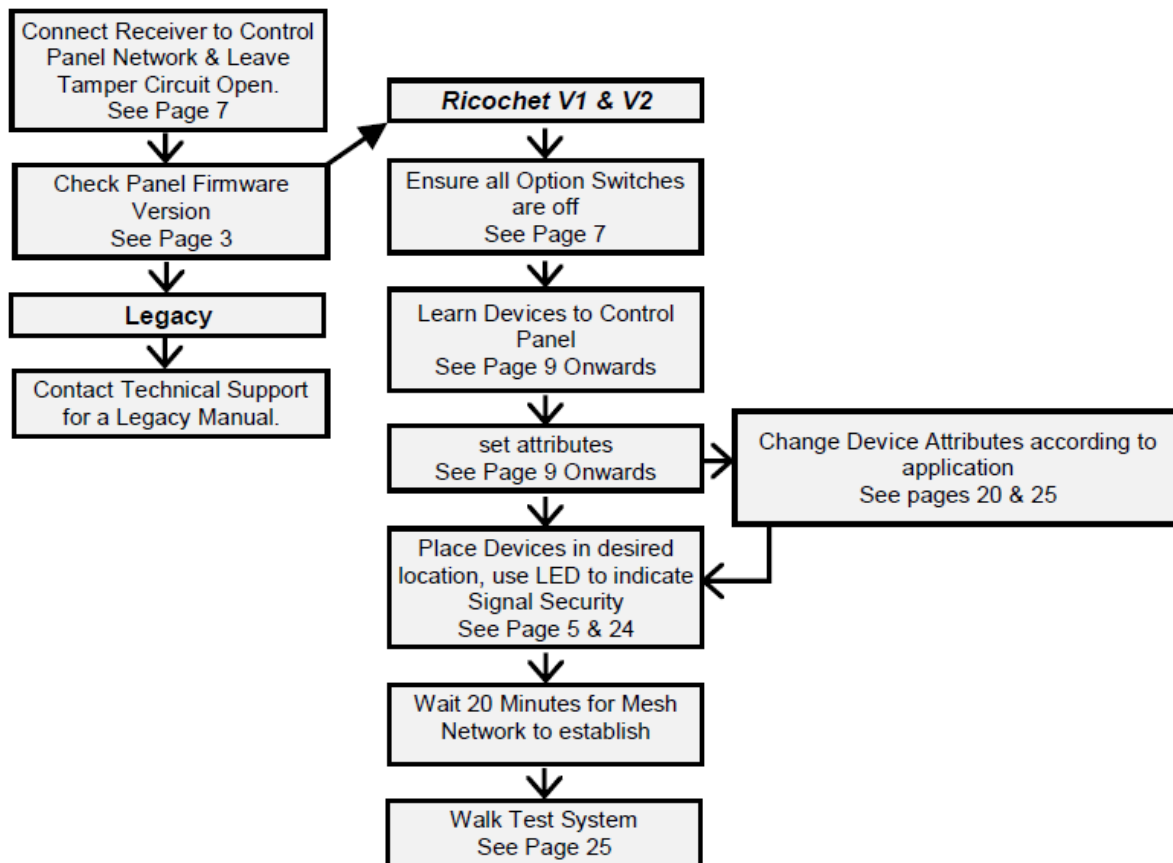



# 4.0 System Overview

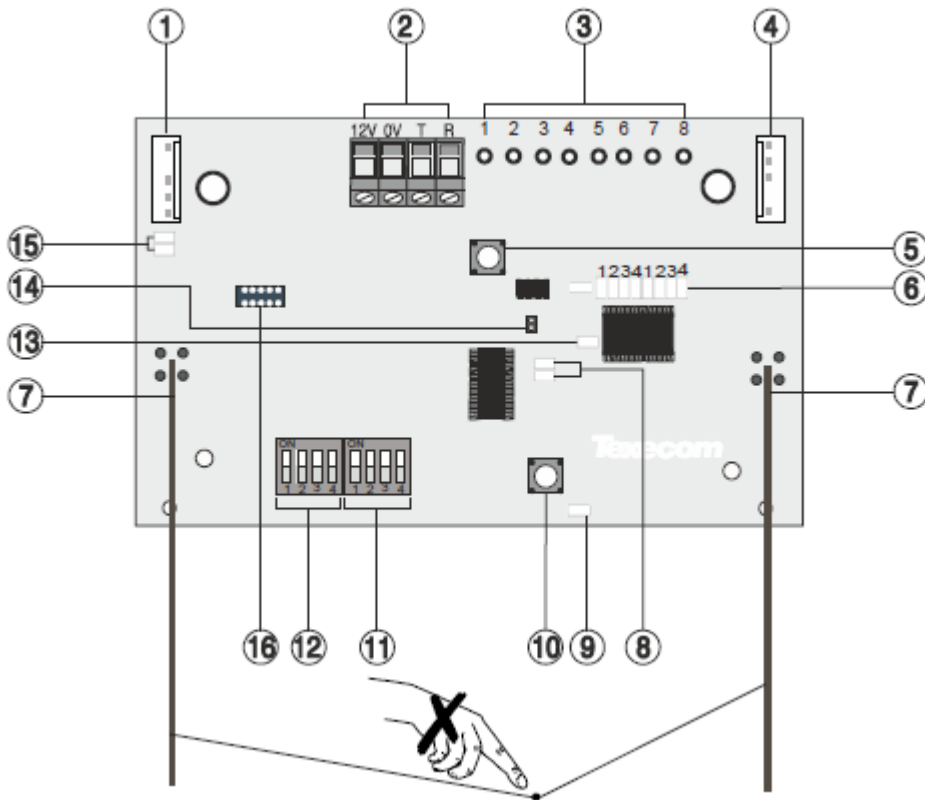

## 1: Engineers Keypad Connection

An engineer's keypad (*Premier/Elite LCD keypad and interface lead*) can be temporarily plugged onto this connector to allow system programming and testing. (Functions dependent on Panel firmware version) Set the keypad address switches to all on.

## 2: Network Connection

The + and - terminals provide power whilst the T and R terminals are transmit and receive data.

## 3: For Future Use

#### **4: Comm. Port Connection**

Serial communications port for connecting the 8 XP-W & 32XP-W to a PC via PC Com/USB Com or Com IP/WiFi for use with *Ricochet Monitor* Software.

#### **5: Lid Tamper**

When open puts the system into commission mode and digitally attenuates the receiver signal by 15Db.

#### **6: Programming/Diagnostic LED's**

Allows programming of devices directly to the receiver, in conjunction with the learn switch (Legacy mode only). For diagnostic information please [see chapter 6.0](#).

#### **7: Antenna**

RF Antenna.

#### **8: Network LED's**

Green LED = Data received by the expander from the panel Red LED = Data transmitted by the expander to the panel. *(The flash rate depends on the mode and RF activity)*

#### **9: Heartbeat LED**

Flashes steadily to indicate that the receiver is functioning correctly. If the light is ON or OFF all the time, then there could be a hardware problem.

#### **10: Learn Switch**

To be used with programming LED's to learn devices directly to the receiver.

#### **11: Options Switch**

Use to select the receiver functionality depending on panel firmware.

Switch 1 ON =firmware dependant, please see the relevant programming section.

Switch 2 ON = Legacy Mode

OFF = *Ricochet*

Switch 3 OFF = Impaq Contact-W Wired Input 2 will report as Tamper (*default*)

ON = input 2 will report as an Alarm.

Switch 4 Walk test

## **12: Address Switch**

Used to assign the address of the receiver on the network

## **13: RF LED**

Flashes when transmitting or receiving RF data

## **14: Tamper Disable**

Disables the lid and rear tamper

## **15: Engineer's Keypad LED's**

Red LED flashes constantly, the flash rate increases when data is being transmitted.

## **16: Flash Programming Port**

Variant dependent, for flashing the expander with updated firmware.

# **4.1 Mounting the Expander**

Remove each screw cap by inserting a flat bladed screwdriver into the slot and turning anti-clockwise, excessive force is **NOT** required. Remove both of the cover screws and put them in a safe place along with the screw caps. Gently pull the cover away from the base applying slight pressure to the sides at the top of the expander if required. The front cover should now be off.

Mount the expander using at least two appropriate countersunk screws (no larger than No. 8). A keyhole slot has been provided to assist mounting and aid levelling.

If required a screw should be placed into the knockout on the rear of the expander to enable the rear/wall tamper.

 *Do not mount near metal or mains supplies. When using with metal control panels a minimum of 50cm gap is required. Do not mount near aerials of any description, or other wireless equipment.*

## 4.2 Wiring

It is strongly recommended that the system is completely powered down (mains and battery) before wiring the expander. Connect the expander to the control panel using 4-core cable as follows:

Expander	Control Panel	Description
+	+	+12V Supply
-	-	0V Supply
T	T	Transmit Data
R	R	Receive Data









The networks are made up of four terminals incorporating power and data. To ensure correct operation, all four terminals on the device must be connected to the corresponding terminals on the control panel or previous device.

Expanders can be connected using 4-core cable. However, it is recommended that 6 or 8-core cable is used as the spare cores can be used to 'Double Up' on the power connections if needed.

 *Standard 7/0.2 alarm cable can be used for most installations. However, under certain conditions it may be necessary to use screened cable.*

## 4.3 Selecting an Address

Each expander must be assigned a different address using the DIL switches located on the PCB. The table below shows the expander addressing:

Address	DIL 1	DIL 2	DIL 3	DIL 4	
1	On or Off	Off	Off	Off	
2	Off	On	Off	Off	
3	Off	Off	On	Off	
4	Off	Off	Off	On	
5	On	Off	Off	On	
6	Off	On	Off	On	
7	Off	Off	On	On	
8	On	Off	On	On	

 *Never set two expanders on the same network to the same address. Expanders are factory set to address 1. On legacy panels the expander will occupy 1 x Expander slot on the control panel, as well as the Network Receiver slot.*

## 4.4 Ricochet Expander Addressing

### Introduction

The address range and switch position will depend on which combination of expanders are being used. Each 32XP-W takes up 4 address slots on the control panel network, however the network slots are virtual until devices are assigned to available zones. It is possible that if a 32XP-W is being used at Address 1, but only 16 devices have been used, Address 3 & 4 are available for hardwired 8XP's or 8XP-W's.

Please see some examples of mixing different types of Expanders on various Elite panels and the addressing requirements.

### Example 1 Totally wireless system(s)

Panel	32XP-W															
	Network 1		Network 2		Network 3		Network 4		Network 5		Network 6		Network 7		Network 8	
<b>Expanders (Max)</b>	2		2		2		2		2		2		2		2	
<b>Premier Elite 88™</b>	Exp 1	Exp 2	N/A	N/A	N/A	N/A	N/A	N/A	N/A	N/A	N/A	N/A	N/A	N/A	N/A	N/A
Expander Address	1	5	N/A	N/A	N/A	N/A	N/A	N/A	N/A	N/A	N/A	N/A	N/A	N/A	N/A	N/A
<b>Premier Elite 168™</b>	Exp 1	Exp 2	Exp 1	Exp 2	N/A	N/A	N/A	N/A	N/A	N/A	N/A	N/A	N/A	N/A	N/A	N/A
Expander Address	1	5	1	5	N/A	N/A	N/A	N/A	N/A	N/A	N/A	N/A	N/A	N/A	N/A	N/A
<b>Premier Elite 640™</b>	Exp 1	Exp 2	Exp 1	Exp 2	Exp 1	Exp 2	Exp 1	Exp 2	Exp 1	Exp 2	Exp 1	Exp 2	Exp 1	Exp 2	Exp 1	Exp 2
Expander Address	1	5	1	5	1	5	1	5	1	5	1	5	1	5	1	5

### Example 2 Premier Elite 168™, + 32XP-W, 8XP-W's & 8XP's mix

Panel	Network 1		Network 2					
	Expanders (Wireless)		Expanders (Mixed)					
<b>Premier Elite 168™</b>	32XP-W		2 x 8XP-W		8XP-W	8XP-W	8XP	8XP
Expander Address	1		5 & 6		1	2	3	4
Devices (Max)	32		16		8	8	8	8
<b>Premier Elite SmartKey™(Max)</b>	16		16		16	16	N/A	N/A

### Example 3 Premier Elite™ 48, 32XP-W + 8XP's

Panel	Network 1	
	Expanders (Mixed)	
<b>Premier Elite 48™</b>	32XP-W	
Expander Address	1	
Devices Used	16	
<b>Premier Elite SmartKey™(Max)</b>	16	

## 5.0 Programming

**For all Legacy Control panels, please contact Technical Support to obtain a legacy manual.**

It is highly recommended that you upgrade the Panel Firmware to the latest version to ensure full compatibility; however the system is backwards compatible as detailed in the table in [chapter 1.0](#).



 *It is not possible to upgrade Premier panels to Premier Elite firmware.*

## 5.1 Premier Elite™ V2.10 > 12/24/48/88/168 Ricochet Learn Menu

**V2.10** contains a dedicated *Ricochet* learn menu accessible via the B/O key when in Engineer menu. This new feature is only for devices, **SmartKey™** should be learnt to the system in the User Menu as described later in this section.

### Learn Devices from first power up

Follow the instructions given in INS176-8 or later for the first power up of the system.

When the "Confirm Devices" menu appears check and make sure all installed Keypads and Expanders are showing; press /Yes and /Yes again to confirm.

Providing the system has a **Ricochet®** enabled expander installed, the following will appear. The flow diagram shows the procedure to learn devices:-

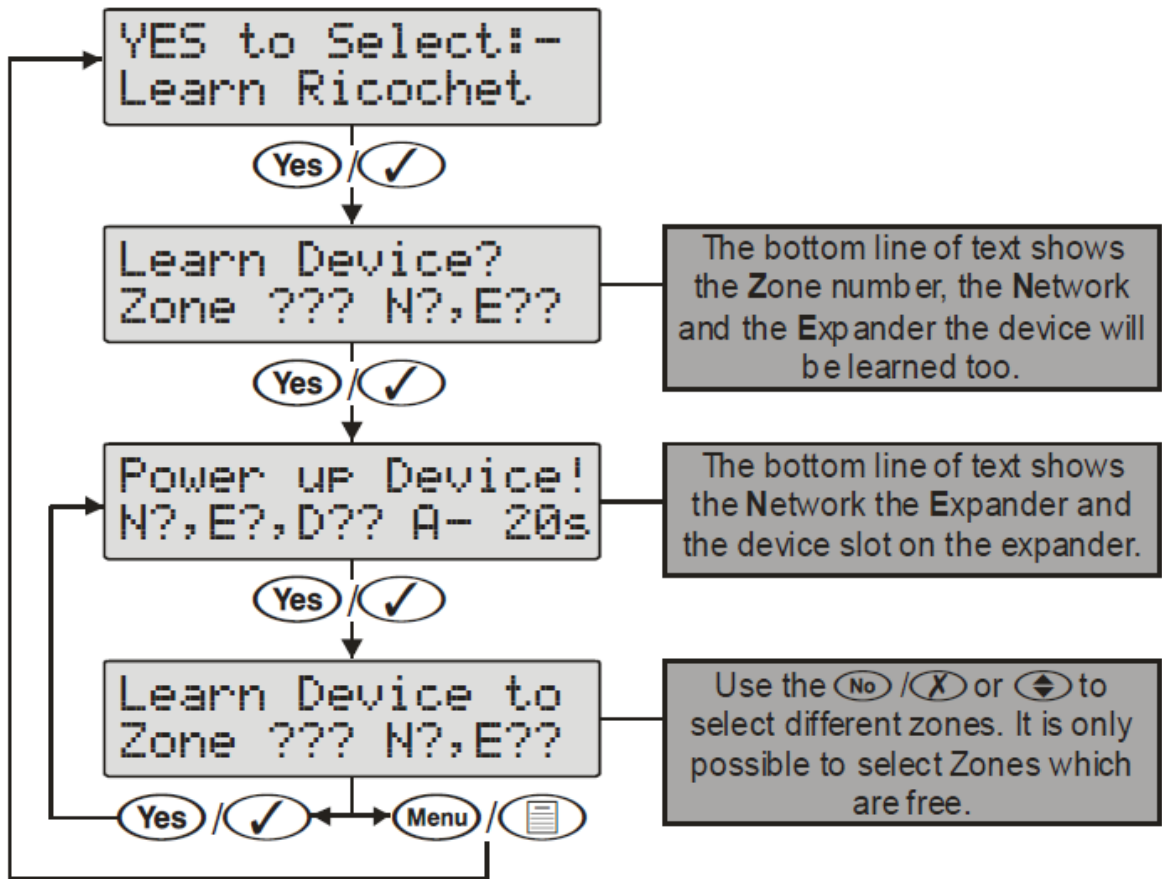

### Access the Learn Menu using the Omit “Hot” key

From any top level engineering menu pressing the / Omit key will take you to the *Ricochet* learn menu above.

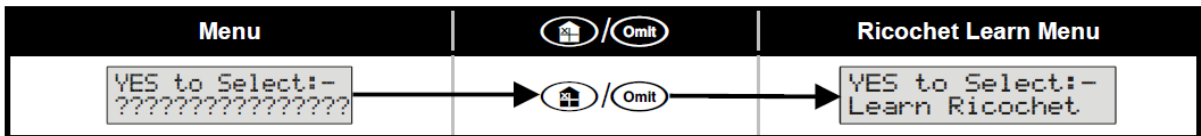

### IMPORTANT



In all cases when entering the Learn menu the next available free Zone will be chosen to learn a device too. It will not be possible to learn a device to a Zone that already has a device learned too it. The number of expander’s on the system will

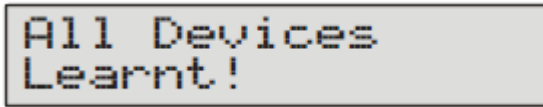

dictate which next “free” zone is chosen to learn too.

When all device slots have been used the following screen will be shown



Pressing the /Menu key will return you to the **Ricochet**® learn menu; pressing the /Reset key will enter the Delete devices menu.

## 5.2 Auto Zone Type & Area

When learning devices, if no editing has taken place of the control panel onboard hardwired zones, these will be switched to **Not Used** after the first **Ricochet**® device is learned to the system; the following defaults will be used for **Ricochet**® devices learned to the system.

Zone	Type	Area
001-008	Not Used	N/A
009	Entry/Exit 1	A
010	Guard Access	A
011 & above	Guard	A

### IMPORTANT

If any editing of any of the on board control panel zones is carried out **BEFORE** any **Ricochet** devices are learned to the system, the control panel zones will remain at factory defaults.



## 5.3 Deleting Devices

### Delete Devices

To delete devices from the system, access the *Ricochet* Learn menu. Any of the methods previously detailed may be used.

The /Reset key is used to access the Delete option.

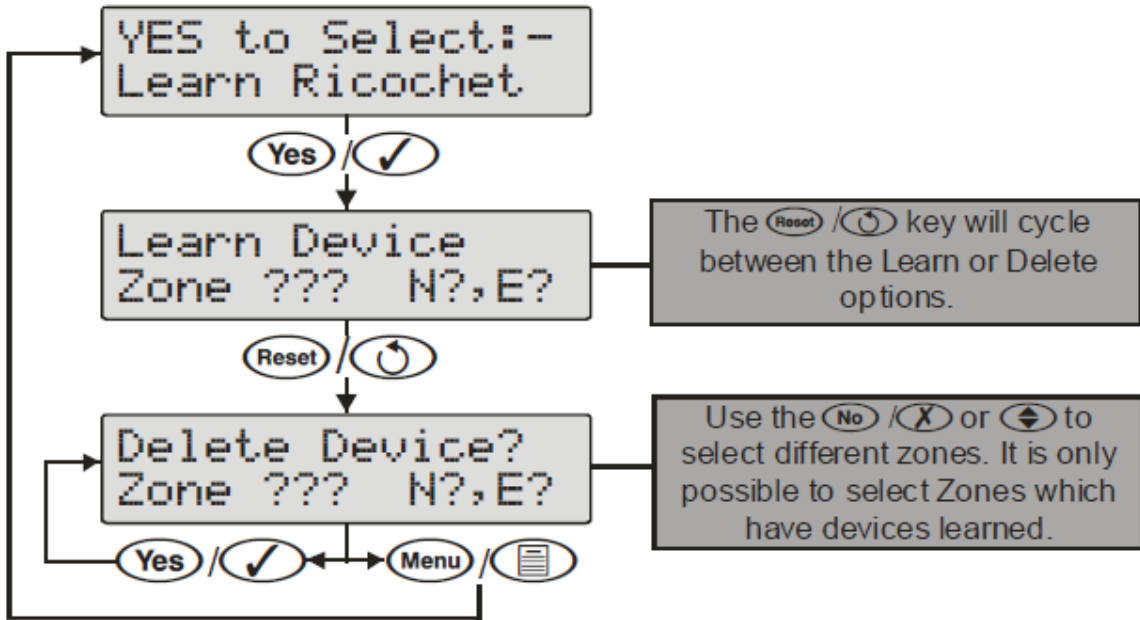

Follow the flow diagram to delete devices from the system.

 *To delete all devices, go to Engineer Utilities/Ricochet Diagnostics. Scroll to the first wireless zone for the expander being defaulted and press  followed by . All zones will be deleted.*





If all devices are deleted from the system the following will be shown

All Devices Deleted!

Pressing the /**Menu** key will return you to the *Ricochet* learn menu; pressing the /**Reset** key will enter the Learn devices menu.

## 5.4 Summary of Keys used

Key	Function
 / Omit	Use this key to access the <i>Ricochet</i> Learn menu from any top level engineering menu.
 / Reset	Use this key when in <i>Ricochet</i> Learn menu to delete devices, or cycle between learn and delete functions
 / Menu	Use this key to exit the Learn Menu.

## 5.5 Premier EliteV2.00 - V2.09 24/48/88/168 & 640 + Ricochet V2.xx

### Option Switches

All Off

### Introduction

V2.xx firmware added the option to learn **Ricochet** devices through the Zone Setup Menu, and **Premier Elite SmartKey™** are learned through the User Setup menu, the "Configure Radio" menu in Engineer's Utilities is now redundant and should only be used for Legacy systems.

### Learning Devices

To learn a device to a Zone select the Zone from the Zone Setup Menu, Zones that are capable of having a **Ricochet** device learnt to them will be displayed as follows:-

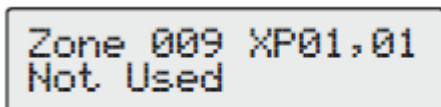

```
Zone 009 XP01,01
Not Used
```

Fig 1

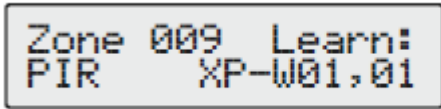

Fig 1 indicates the pre-assigned zone number, the expander being used and the device slot on the expander.

Once a device has been learnt the display will be as Fig 2:-



Zone 009 Learn:  
PIR XP-W01,01

**Fig 2**

If you are unsure if a zone already has a device learned to it, you can go to the menu as in Fig 1, press /Reset and then /No if a device is already learnt the display will look like Fig 2, if not then it will look like Fig 3

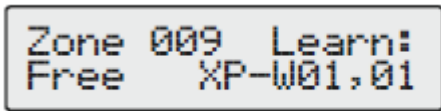

Zone 009 Learn:  
Free XP-W01,01

**Fig 3**

Please see the diagram on the next page to learn devices.

## Deleting Devices

To delete devices from the expander is the same as learning them; choose the zone you wish to delete, and follow the procedure to learn the device, when the screen shows “Learning” press /Reset.



*To default the expander completely put option switch 1 & 2 to ON and hold the white programming button until the expander programming LED's all illuminate and turn off.*

## Device Modes of Operation

### Always Awake

This mode should only be used on devices which are required to signal at all times and is the default setting for perimeter detection devices such as Contacts and Shock sensors & PA Buttons.

### Auto Mode

When in Auto Mode, devices poll at 15 minute intervals. Following activation, devices will not transmit the same activation again for a period of 3 minutes. This mode of operation is the default mode for all single technology motion detectors.

## **Hybrid Mode**

Hybrid mode is used to control the reporting functions for devices. When in this mode devices are awake only when the system is set. Devices are woken up by the control panel at the point of arming. The system will display "Preparing to Arm". When the system is disarmed the devices will be put back to sleep. This mode of operation is the default mode for all Dual Technology motion detectors.

*N On very large systems (100 devices +) a small delay may be experienced when arming the system, this is normal as the expanders on the system wake up the relevant devices.*

*N Premier Elite DT-W should ALWAYS be used in Hybrid mode, failure to do this will have an adverse affect on battery life.*

## **Device Specific Mode**

Device Specific mode is used to control the reporting functions for devices. Devices that use this mode of operation have specific operating parameters and should not be altered. This mode of operation is the default mode for all Fire detectors (Smoke, Heat and any other variant), & Internal/External Sounders.

## **Expander O/P Mode**

Expander O/P modes are for future use and should not be used with any of the devices listed above.

## **Zone Types & Attributes**

Detailed instructions for programming can be found in INS176-8 or later.

To Learn Devices through the Zone Setup menu please follow the diagram on the next page.

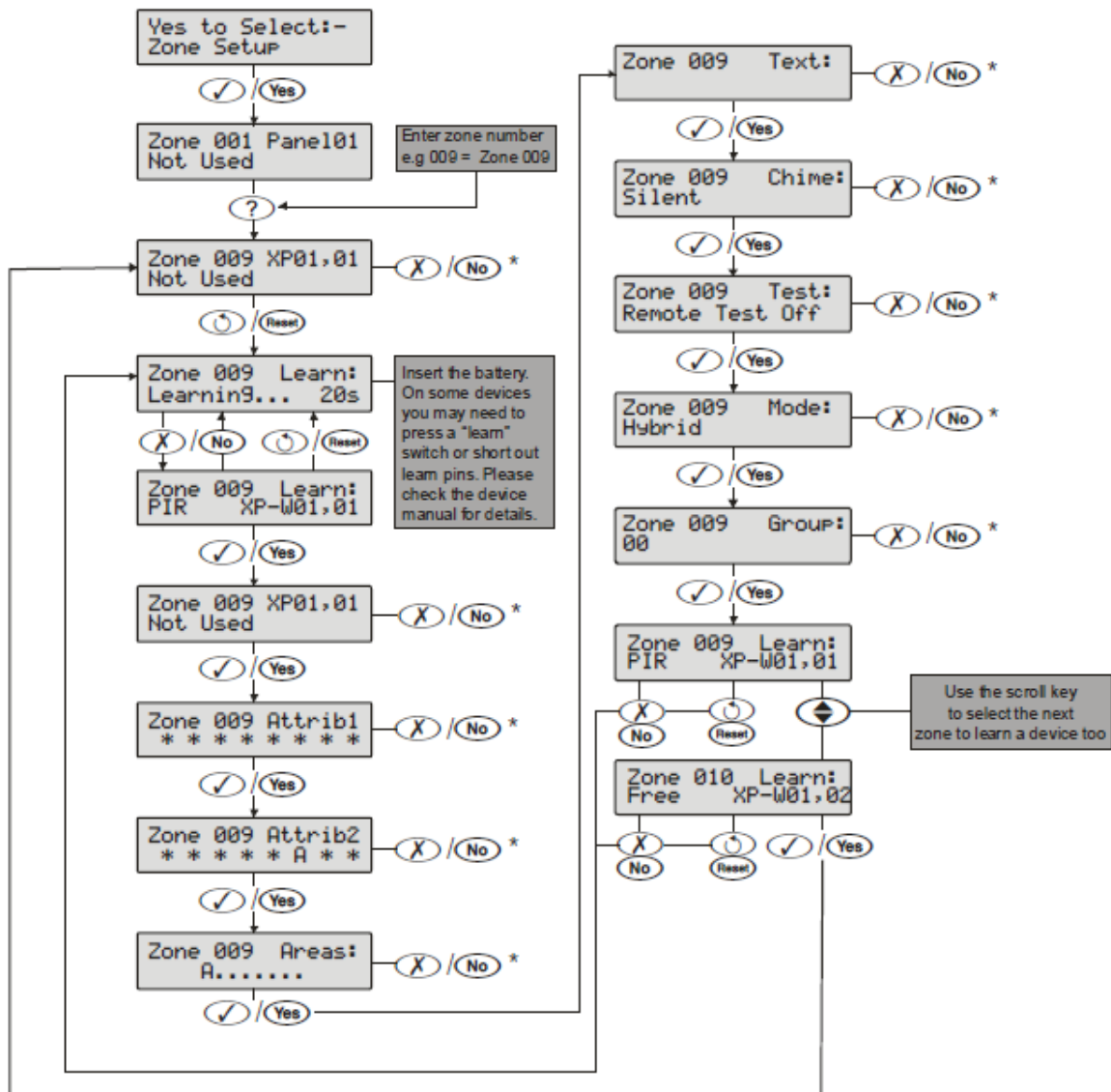

\* Please refer to INS176 " Zone setup" for the details when using the X and NO key to change these settings

## 5.6 Premier Elite SmartKey™

### Introduction

**Premier Elite SmartKey™** are now learnt and all functionality managed through

the “Setup Users” Menu.

*Ricochet* and **Premier Elite Series** V2.xx firmware upgrades add additional capabilities to the management of **Premier Elite SmartKey™**. In multiple expander systems it is now possible to choose which zones (and therefore expander) the **Premier Elite SmartKey™** will use for its routing, LED and Aux functions can also be changed within the “Setup Users” menu.

All users on the system can have a **Premier Elite SmartKey™** a TAG and a code, or any combination of them.

This section only deals with **Premier Elite SmartKey™** learning and routing, all other user programmable options can be found in INS176-8 or later **Premier Elite Series Installation Manual**.

 *Great care should be taken when using large numbers of **Premier Elite SmartKey™**, only one **Premier Elite SmartKey™** per expander can be used by the system at any one time, and on Multiple expanders systems, or large sites, functionality should be checked in all areas of the site where the device may be used.*

## **Premier Elite SmartKey™ Routing**

**Premier Elite SmartKey™** should only be learned to the system AFTER all devices have been learned and placed in their final location. Whilst it is possible to learn at any point during the programming of the system, learning and testing the functionality of the **Premier Elite SmartKey™** after all devices have been placed will ensure that the **Premier Elite SmartKey™** performs as expected, and works in locations where the user would expect it too.



## **Route By**

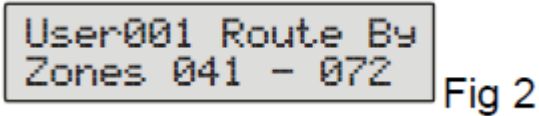
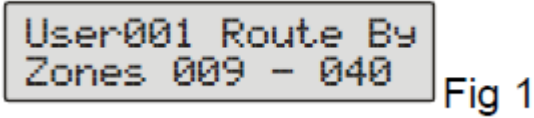

The Route By function allows you to select which Zones (and therefore expander) the **Premier Elite SmartKey™** will use on the system for its routing. This should be selected BEFORE the device has been learned.

In the examples below Fig 1 shows the zones associated with Expander 1, which is a 32XP-W, and Fig 2 shows Expander 2 which is also a 32XP-W, when using 8XP-W







there will obviously be less devices that the **Premier Elite SmartKey™** can use.



The / key is used to select this menu and the  key used to select which expander and associated zones will be used

Once a **Premier Elite SmartKey™** has been learned the / key will show which zones are being used for routing. It is not possible to alter this once learned. To change the routing the **Premier Elite SmartKey™** should be deleted and the process started from the beginning.

#### Deleting a Premier Elite SmartKey™

Deleting the **Premier Elite SmartKey™** from the user is a similar process to learning, at the appropriate point in the menu press / followed by /, then / the **Premier Elite SmartKey™** will be removed from the User. To delete all user data see INS176-8 or later.



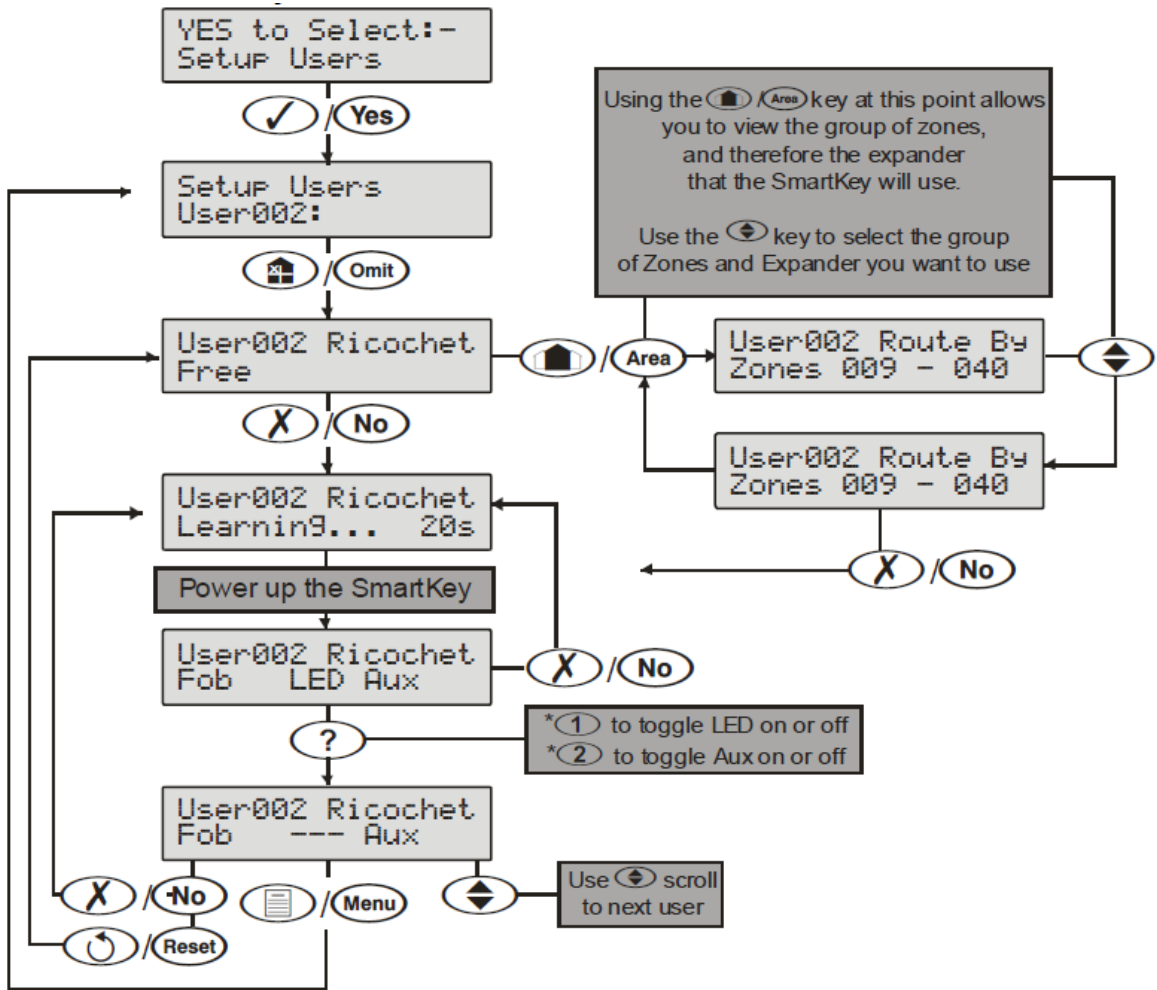

\*Please refer to [chapter 8.3](#) for details of the LED & AUX functions

**NOTE** To disable two stage arming please refer to INS176-8 or later and check Global Options/System Config options 38 & 48.

**NOTE** Once the 16 slots on a XP-W are taken up, the learn process will fail and display 'No spaces left'.

**NOTE** In either of the **Premier Elite SmartKey™** menu displays, any **Premier Elite SmartKey™** that logs onto the system will cause the menu to change to that **Premier Elite SmartKey™** - a handy way of finding out which user a **Premier Elite SmartKey™** in your hand belongs to!

## 5.7 Premier 412/816 V9.5 & V11.10 & Later, Premier 832 2.5 & V4.10 & Later

Follow these instructions to learn devices to the system, once completed follow the relevant section of the control panel manual to programme zones and user attributes.



For V9.5 & V2.5 the number chosen for learning will determine the device slot taken on the expander. This should always be started at 01. If started at 05 for example, the next devices will go to 06 and you may run out of device slots.



For V16 panels all Ricochet devices including SmartKey now take the next available slot.

### Option Switch Settings

For this version of firmware all option switches 1,2 & 4 should be OFF.

### Expander Settings

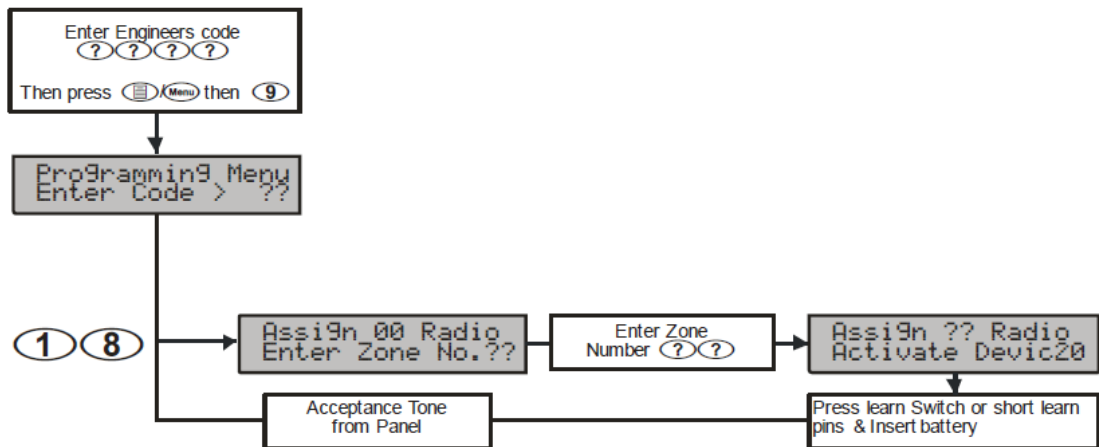

The expander should be set to address 1.

### Detectors are assigned to zones as follows:

1. Select engineer's mode by entering the engineer code followed by

/Menu then **9**.

2. Enter **1** **8** to select the **Assign Radio Device** menu, if an error tone is generated then the receiver is not installed or configured correctly.
3. Enter the two digit zone number that you want to assign the detector to e.g., **0** **1**\*.
4. Press the learn switch or short the learn pins and insert the battery. The panel will generate an acceptance tone and the detector is now assigned to the selected zone.
5. Program the zone type and attributes as required. **Note:** The Zone Wiring must be programmed as "Double EOL", if a tamper response is required from the detector.
6. Repeat steps 2 - 5 for other detectors.

*\*When using a Premier Elite 8XP-W devices can only assigned to Zones 1-8 when learning. Using Wintex the learned Zones can be changed to any that are available.*

### Removing Detectors

If a detector is no longer required it must be unassigned from the system. To remove a detector from a zone, proceed as follows:

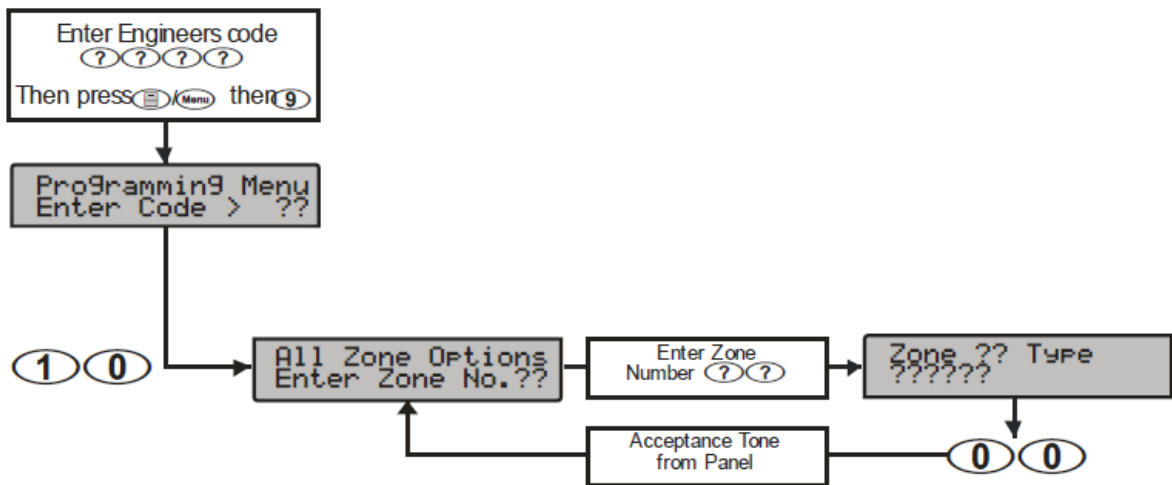

1. Select engineer's mode by entering the engineer code followed by /Menu then **9**.

2. Enter **1 0** to select the **All Zone Options** menu.
3. Enter the two digit zone number that you want to remove the detector from e.g., **0 9**.
4. Enter **0 0** to program the zone type as **Null**. The panel will generate an acceptance tone and the detector is no longer assigned to the selected zone.

## Learning SmartKey™

All **SmartKey™** must be assigned to one of the available users on the system. **SmartKey™** will always be learned to the last available slot on the receiver and work downwards. The users available will vary depending on the control panel:

Control Panel	Available Users
Premier 412	Users 1 to 31
Premier 816	Users 1 to 31
Premier 832	Users 1 to 63

**SmartKey™** are assigned to users as follows:

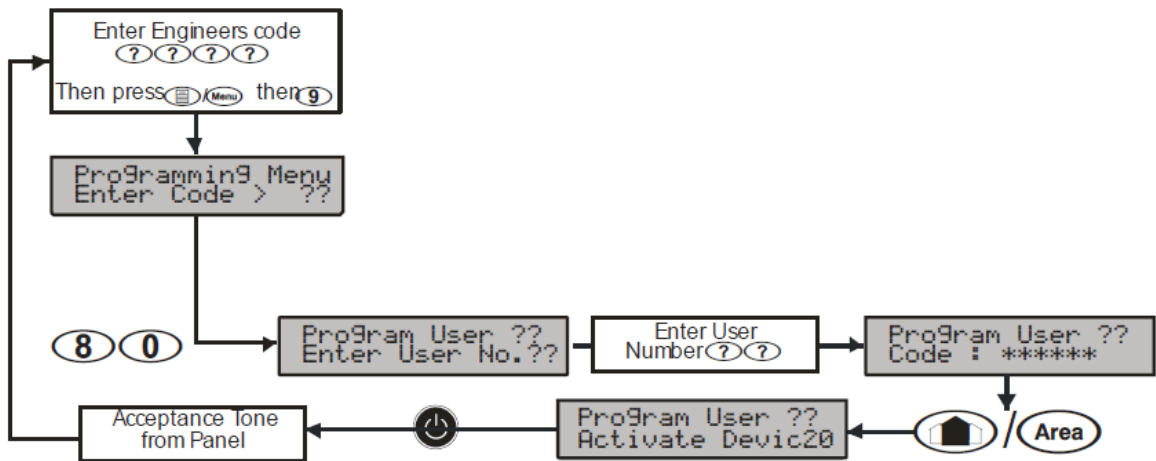

1. Select engineer's mode by entering the engineer code followed by **[Menu] / Menu** then **9**.
2. Enter **0 8** to select the **Program Users** menu.
3. Enter the two digit user number that you want to assign the **SmartKey™** to

e.g., **0** **1**.

- Press the **Area** key, if an error tone is generated then the receiver is not installed or configured correctly (see Receiver Installation above).
- Press the power button **⏻** on the **SmartKey™**, the panel will generate an acceptance tone and the **SmartKey™** is now assigned to the selected user.
- If required, a user access code can also be assigned to user in the normal way.

## SmartKey™

If a **SmartKey™** is no longer required it must be unassigned from the system. To remove a **SmartKey™** from a user, proceed as follows:

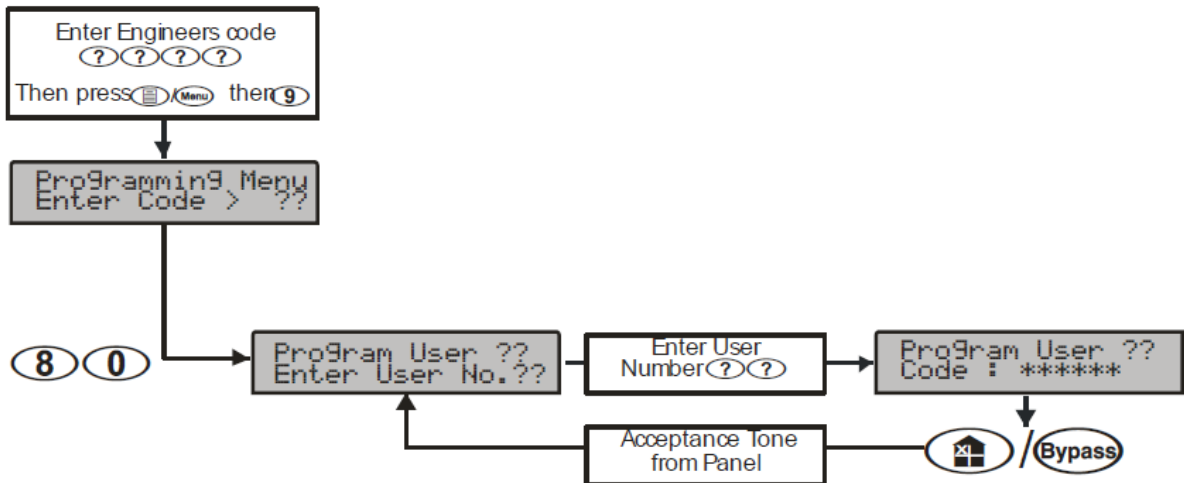

- Select engineer's mode by entering the engineer code followed by **Menu** then **Menu**.
- Enter **8 0** to select the **Program Users** menu.
- Enter the two digit user number that you want to remove the **SmartKey™** from e.g., **0 1**.
- Press the **Bypass** key, the panel will generate an acceptance tone and the **SmartKey™** is no longer assigned to the selected user. **Note:** If the **SmartKey™** was assigned to user 02 onwards the user access code is also deleted.

## 5.8 Learning Devices directly to the 8XP-W & 32XP-W

Learning devices directly to the receiver is only applicable to legacy systems..

**For all Legacy Control panels, please contact Technical Support to obtain a legacy manual.**

## 5.9 Using the Engineers Keypad

The Engineers Keypad functionality is only applicable to legacy systems..

**For all Legacy Control panels, please contact Technical Support to obtain a legacy manual.**

# 6.0 Ricochet Diagnostics

## 6.1 Premier Elite 8XP-W & 32XP-W V3.XX

Diagnostic information is provided at the expander using the power and learn LED's. On the 32XP-W the 8 LED's using a logical OR function showing information for 2 devices per LED.

Green Power LED	Slow Flash = Learning	Fast Flash = Device/s being updated by panel
-----------------	-----------------------	--

### Bank of 8 LED's

These show the zone status of the first 8 zone pairs. LED1 shows the logical OR status of Zone 1 & 2, LED2 shows the logical OR status of Zone 3 & 4, etc.

LED	Status
Off	Secure
On	Alarm
Slow Flash	Trouble
Fast Flash	Alarm & Trouble
Blink	Poll Error

## Device Update

When powered up the expander will enter “Device Update” mode for approximately 30 seconds. The green power LED will flash rapidly. During this time no devices can be learnt or deleted.

## 6.2 Premier elite V2.XX & later



Engineer Utilities now includes a new *Ricochet* Diagnostics menu. This menu displays information about the live system, and is split into **Premier Elite SmartKey™** and **Ricochet** devices via Zones and Users.

### Devices

For Devices the following information can be viewed:-

- Routing
- RSSI
- Alarms and Status
- Device visibility
- Time since last message



The  /  key can be used to move between the options for each Zone.

### Premier Elite SmartKey™

For Premier Elite SmartKey™ the following information can be viewed:-

- Routing
- RSSI
- **Premier Elite SmartKey™** Button
- Status

### Interpreting Keypad Displays

#### Routing

The image below shows that Zone 009 is routing through 14 and then 7 to the expander, for Premier Elite SmartKey™ this may vary depending on where & when

the reading is taken. If question marks appear in the display it means the information is not available.

```
Zone 009 PIR
->014->007->XP
```

### RSSI

Each value in the image below represents the RSSI levels in dBm (on V2 it is shown as %) at each of the hops. If question marks appear on the display it means the information is not available.

```
Zone 009 PIR
69>> 80>> 57 XP
```

 *If question marks appear it could be because either the system has just been powered up and information has not been collected yet, or on large systems the information is not in memory. To populate the display activate the device and the information should appear.*

### Device Messages

```
Zone 001
Not Ricochet
```

The chosen zone does not have a Ricochet device learned to it.

```
Zone 009 PIR
Ms9 ??? mins ago
```

shows the last time the device communicated this represents the last

```
Zone 009 PIR
>1hr since ms9
```

This is a warning showing that the last communication from the device was over an hour ago.

```
Zone 009 PIR
No ms9 recvd yet
```

This display shows that no message has been received yet, this would normally be seen on a recently powered up system, wait 15 minutes from power up before checking the diagnostics information.

### Signal Security™



```
Zone 009 Shock
????
```

This display shows information relating to signal security on an 8XP-W. 4 windows are available to show information; each window represents two devices, (Odd & Even device slots). Each window could show any of the information detailed in the table below

?	No information is available
_	The chosen device cannot “see” either of the devices
O	The chosen device can see the ODD device(s)
E	The chosen device can see the EVEN device(s)
B	The chosen device can see BOTH devices

### Example

```
Zone 009 Shock
_OEB
```

This display shows information relating to signal security on an 8XP-W. 4 windows are available to show information; each window represents two devices, (Odd & Even device slots). Each window could show any of the information detailed in the table below

Display	_		O		E		B	
Device	1	2	3	4	5	6	7	8
Can see	x	x	✓	x	x	✓	✓	✓

 *On the 32XP-W there are 16 windows to show information from the 32 devices of the system; the format is the same.*

### Device Status

```
Zone 009 Shock
Status: aaaSpdtt
```

Secure/OK	Active/Fault	Type
a	A	Mag1
a	A	Mag2/Sho
a	A	Reed/PIR
s	S	Poll/Supervision
p	P	Power/Battery
d	D	Device
t	T	Rear
t	T	Front

### **Premier Elite SmartKey™ Messages**

```
User000 Ricochet
Not Ricochet
```

The chosen user does not have a *Premier Elite SmartKey™* associated with them.

```
User002 Ricochet
Not connected
```

The *Premier Elite SmartKey™* is not switched on

```
User002 Ricochet
Logon      Bat OK
```

Shows the battery is OK and the fob has logged onto the system.

```
User002 Ricochet
Partarm    Bat OK
```

Shows the different messages displayed when the relevant buttons are pressed.

```
User002 Ricochet
Disarm     Bat OK
```

```
User002 Ricochet
Fullarm    Bat OK
```

```
User002 Ricochet
Aux?       Bat OK
```

Shows which Aux button has been pressed when in Function Mode.

```
User002 Ricochet
Panic      Bat OK
```

Shows the Panic function has been activated

```
YES to erase
unknown keyfobs
```

Use this option **ONLY** if the panel has been replaced and not all **Premier Elite SmartKey™** are recognised by the new panel, or if the error tone is heard when learning new Premier Elite SmartKey™. The unknown SmartKey™ **MUST** be powered on before pressing yes.

**NOTE** This option **DOES NOT** remove known Premier Elite SmartKey™, use the Delete option in Setup Users.

### Ricochet Diagnostics Menu

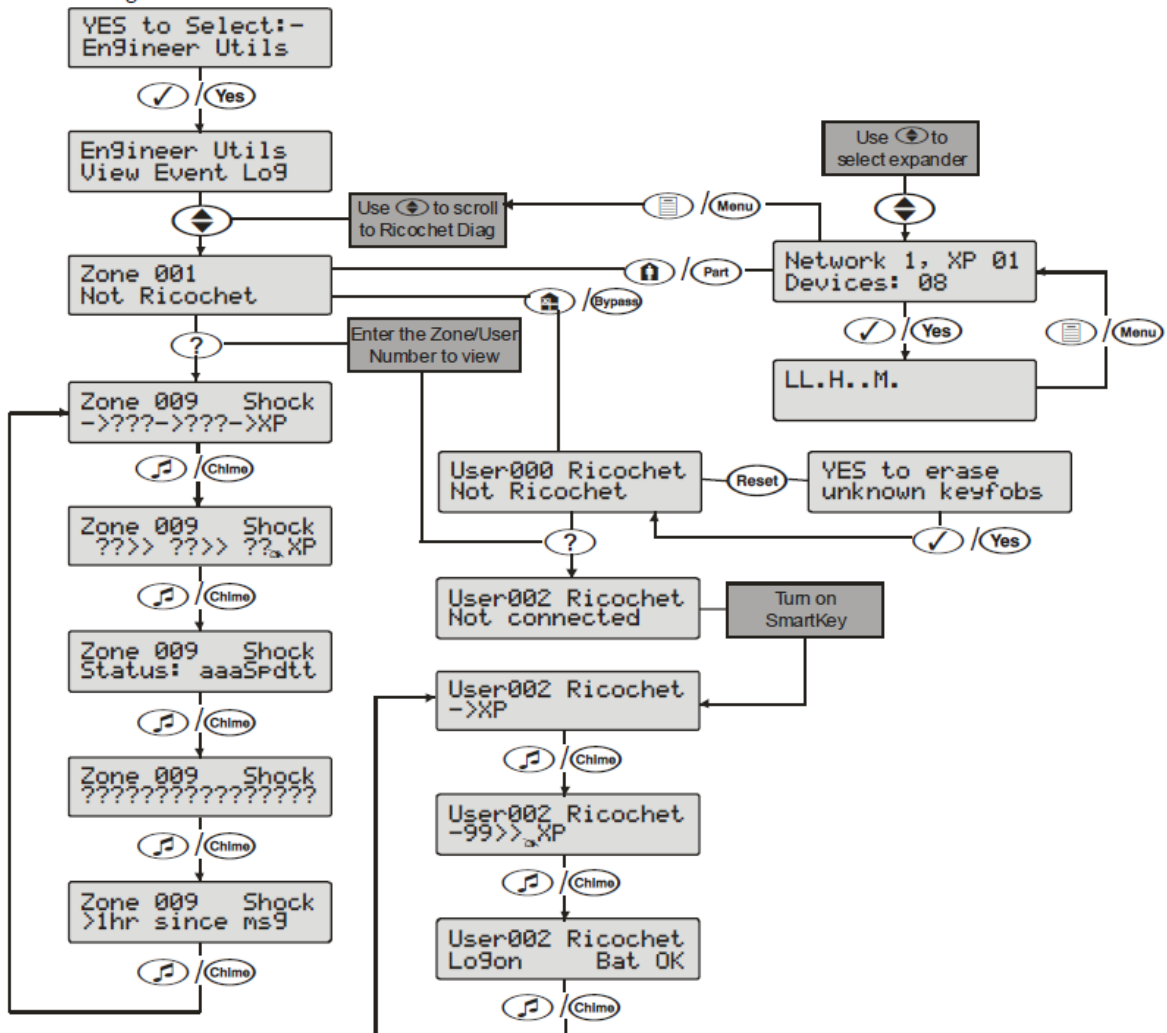

## 6.3 Premier Elite V3.XX>

### Low signal security

For V3 the keypad can display basic signal security information for each device on an expander. Each device will show **H High**, **M Medium** or **L Low** signal security. The system is updated live and therefore it is possible to determine changes by moving devices, or by adding more to the system. The information displayed replicates what is seen when using Ricochet Monitor.

### Low Signal Security Displays

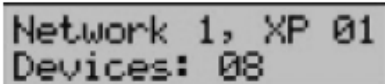

```
Network 1, XP 01
Devices: 08
```

The network, expander and number of devices learnt to the expander will be shown. Use the U key to select the expander you wish to view.



```
.....
```

No devices learnt to the expander. 8 spaces available.



```
LL.....
```

2 devices out of eight learnt showing Low signal security. Adding more devices will improve the reading, moving them will not.



```
MMLLLLLL
```

8 devices on the system, 2 show Medium signal security. 6 showing Low signal security. Moving the devices may improve the system.

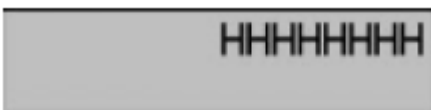

```
HHHHHHHH
```

8 Devices learnt to the system, all devices showing High signal security, the system is operating perfectly.

## 7.0 Modes of Operation

### 7.1 Commission Mode

#### Expander

The expander has a Commission Mode, which when operated ensures secure communications with devices on the system. Commission Mode is automatically

enabled when the expander is in tamper. When in commission mode the RF signal is attenuated by -6 dB, and will reject weak signals. This means that when devices are placed into their final locations and communications are established, you can be sure that the signal path is secure, and robust.

After entering Commission Mode the expander will also instruct the devices to poll in every 4 minutes, rather than the standard 15 minute poll time. The instruction will be sent with the next available poll to the device.

### Device Commission Mode

At any time, when a tamper is generated on a device it will enter commission mode, the devices will do this regardless of the state of the receiver. Closing the tamper circuit will activate the LED for a short period of time whilst communication with the receiver is established.

The LED will flash, indicating the device is trying to communicate with the receiver, once communication is successful the LED will come on solid and then go out.

If the LED does not flash but simply comes on solid when the tamper is closed, then a valid & secure communication has taken place. If the LED flashes and then goes out, without going solid communication has failed.

This method of commissioning devices ensures that valid and secure communication is taking place and that signals are reaching the receiver. It is recommended that Device Commission Mode is used in conjunction with Expander Commission Mode. See Above.

## 7.2 Device Specific Functions

### *All devices*

All settings & mounting height recommendations are covered in the relevant device manual.

### *Impaq Plus-W*

Sensitivity and device placement instructions are covered in the device manual.

## *Impaq Contact-W*

The ***Impaq Contact-W*** has 3 additional inputs labelled MAG 1 COM MAG 2, these inputs can be used for any N/C device. If the Reed switch is disabled the device can be used as a transmitter for any device wired into one of the two inputs.

The two additional inputs are NOT independently programmable of the reed switch, when mapped to a panel zone if either the reed switch or any of the inputs are triggered the zone which the device is mapped too will go active.

**Switch 3** on the expander controls how MAG 2/COM reports to the control panel. By default the switch is OFF and anything connected to MAG 2/COM will report as a tamper. When switch 3 is ON MAG 2/COM will report as alarm.

In the case of the ***Impaq Contact -W*** being used to trigger 24 hour circuits, or where the zone is required to chime, ensure the device attributes are at the default “Always Awake” as detailed in [chapter 8.2](#).

The two additional inputs may also be used to transmit N/C signals from any other locally powered or self-powered device, depending on the type of device used you should choose the device attributes to suit.

## 7.3 Walktest Mode

Walktest Mode can be initiated from the Control Panel, Engineers Keypad, ***RICOCHET Monitor*** or directly on the expander.

When in Walktest mode LED's are enabled and the response time for devices between activations is reduced to 10 seconds. Walktest will last for 1 hour.

### **Control Panel**

Please refer to the Control Panel installation instructions to enter Walktest mode. The countdown timer does NOT appear on the panel's keypad.

### **Expander**

Option switch 4 toggles Walktest mode on and off. To enable Walktest mode from the expander switch Option switch 4 to the ON position. To leave Walktest mode

turn option switch 4 OFF. The countdown timer will be visible on the engineer's keypad or *Ricochet Monitor*.

## **Engineers Keypad**

***Legacy systems only. Please contact Tech support for information.***

The countdown timer will appear.

## ***Ricochet Monitor***

Press the button . The countdown timer will appear.

# **8.0 System Attributes**

## **8.1 Polling**

Polling occurs between the devices and the receiver at a pre-determined interval of 15 minutes. This helps to conserve battery life. Poll intervals are set to 4 minutes when the system is in Commission Mode. Please [see chapter 7.1](#) for details. The standard poll time is not adjustable. If the system is powered down for more than 1 hour, the devices will go into an Offline Mode to conserve battery life, in this case it can take up to 2 hours for all devices to come back online, alternatively each device should have its tamper circuit opened to force communications. When forcing the devices to come back online the same setup principles should be used and devices closest to the receiver should be activated first, this will again allow the mesh network to be established.

## **8.2 System Devices**

### **Auto Mode**

When in Auto Mode, devices poll at 15 minute intervals. Following activation, devices will not transmit the same activation again for a period of 3 minutes.

## Always Awake

This mode should only be used on devices which are required to signal at all times and is the default setting for the **Impaq Contact-W** and **Impaq Plus-W**. For example a **Impaq Contac-W** on a door which you need to know is opened, regardless of system state; or devices such as PA buttons & smoke detectors which have been connected to the inputs of the Magnetic Contact. [See chapter 7.2](#) for details. The number of devices on a system in this mode should be kept to a minimum.

## Device Specific

This mode is assigned to devices that need to operate in a specific way and should not be changed. Life safety devices and sounders will typically use this mode.

## Hybrid Mode (V2.xx>)

Hybrid mode is used to control the reporting functions for devices. When in this mode devices are asleep when the system is unset, and are woken up by the control panel at the point of arming. When the system is disarmed the devices will be put back to sleep.

## Expander O/P Mode

Expander O/P modes are for future use and should not be used with any of the devices listed above.



*On very large systems (100 devices +) a small delay may be experienced when arming the system, this is normal as the expanders on the system wake up the relevant devices.*



*Premier Elite DT-W should ALWAYS be used in Hybrid mode, failure to do this will have an adverse effect on battery life.*



*As this is a dynamic bi-directional system any device which is Always Awake has the capability to shorten battery life of other devices. Please see the Battery Considerations section in [chapter 8.4](#).*



## 8.3 Premier Elite SmartKey™

### LED Indications

#### **SmartKey™ Status LED**

The Status LED has four colours. This LED cannot be disabled.

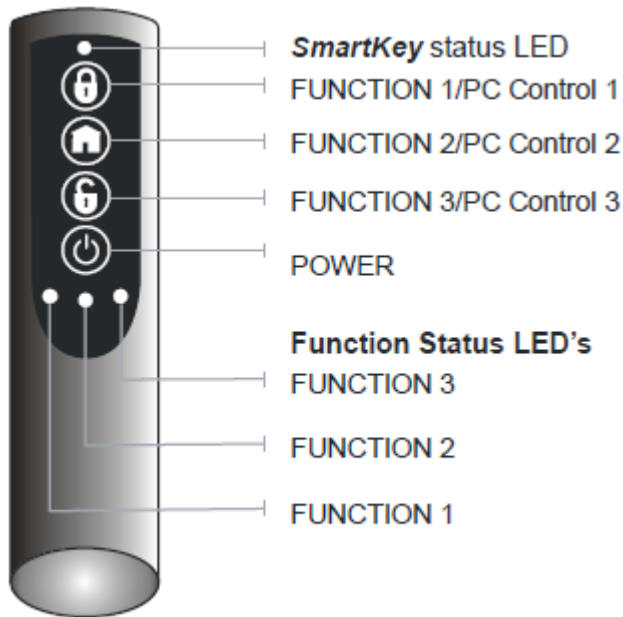

1. Pink = Power Up or Down
2. Green = Successful communication with the system
3. Flashing Blue = communication with system.
4. Red = Out of Range
5. Turquoise = Function Mode

NOTE on Premier 412 816 & 832 Function 1 is the Arm Button and Function 2 is the Disarm button.

### PA Activation

By default PA activation is enabled on the **SmartKey™**, however the control panel should be programmed to enable Radio PA. Please refer to your Control Panel

manual for details.

## Enable/Disable Alarm Status LED's

The Alarm Status LED's can be enabled or disabled either from the Engineers Keypad, or *Ricochet Monitor*.

 *Alarm Status LED's are not available on the Legacy Premier 412, 816 & 832. For legacy Premier 24/48/88/168 & 640.*

## Auxiliary Functions

The **SmartKey™** can also be used to activate auxiliary devices from the control panel outputs. The function keys should first be enabled either from the Engineers Keypad, or *Ricochet Monitor*. Once enabled the user can enter Auxiliary mode by pressing the power button when the **SmartKey™** is powered up, the status LED will change from blue to turquoise to indicate Function mode.

Once enabled the outputs should be programmed in the control panel to activate the desired function. Please refer to the Control Panel manual for details on how to programme the outputs.

 *The Function Keys use the PC Control virtual outputs on the control panel and are pre assigned, in the case of the Premier 24/412/816 & 832, only function buttons 1 & 2 may be used.*

## Instant Disarm

Pressing the DISARM button without powering up the **SmartKey™** will disarm the system, or all areas allocated to the user, whilst the disarming process is taking place the alarm status LED's will change from the ARMED to the DISARMED state.

## Alarm Status LED's

The alarm status LED's when enabled will indicate the system status to the user, however considerations need to be given when the user is allocated to more than one area.

In the case of multiple areas being assigned to a **SmartKey™** user the alarm

status LED's will indicate the status of all areas the user has access too.

For example in a two area system where one area is ARMED and one is DISARMED, both the ARMED & DISARMED LED's will be on. If the user then presses the DISARM button, the area which is currently ARMED will be DISARMED, and vice versa.

If the user has control over three areas and only the DISARMED LED is illuminated, it means that all areas the user is assigned too are DISARMED, pressing the ARM key will arm all three areas.

 Great care should be taken if the user is assigned to more than one area or subsystem. It is not possible for the user to determine from the **SmartKey™** which areas are ARMED and which are DISARMED. It is important that in these situations the user has access to an alternative means of setting and unsetting the system so that the possibility of false alarms from the system are minimised.

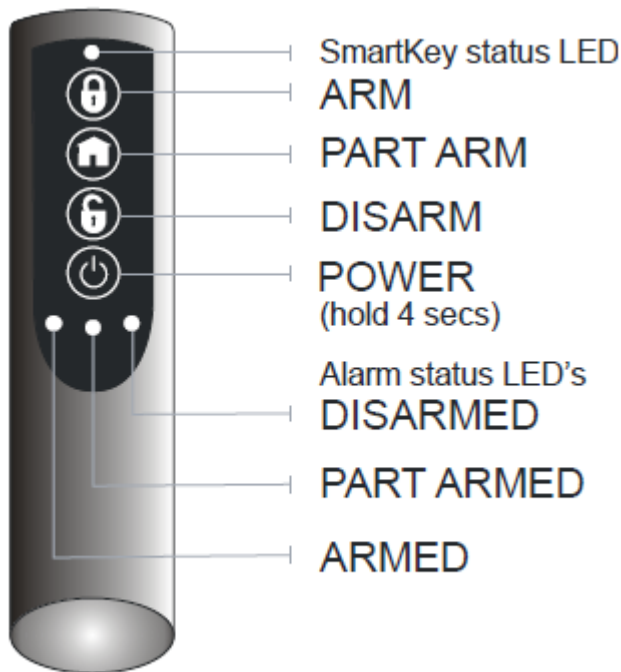

### Arm Fail Indication

If the system or any area assigned to a user fails to arm, all three alarm status LED's will flash to indicate an arm failure. In the case of users assigned to multiple areas the whole system should be unset and each area investigated to determine

the cause of the arm failure.

## 8.4 Battery Considerations

Battery life for all devices will be determined by system complexity, the number of devices that hop, and the use of the Always Awake mode.

In a typical system, battery life should be up to 4 years for devices, hopping devices should achieve between 2-3 years.

Always Awake. Mode should **NOT** be used for devices which are subject to multiple activations.

Batteries should only be replaced with an equivalent of those supplied with the devices. Please see the device instructions for details of the correct battery required.

<b>SmartKey™</b>	The <b>SmartKey™</b> battery should last 2-3 years in normal use. <b>V1 SmartKey™</b> batteries are <b>NOT</b> replaceable; in the case of a <b>SmartKey™</b> battery failing the device should be replaced. Please contact your distributor to arrange a replacement.
<b>Low Battery Warning</b>	All devices, including <b>SmartKey™</b> will transmit a Low Battery Warning when there are three months remaining.
<b>Battery Maintenance</b>	The system should be checked for low battery warnings at each service interval or a minimum of 12 months whichever is sooner.

## 8.5 Premier Elite 8XP-W & 32XP-W Power Loss

If the power to the receiver is lost for more than one hour, all devices on the system will enter an “Offline” mode to preserve battery life.

When power is replied to the receiver it can take up to two hours for all devices to be recognised by the system.

To resolve this issue quickly each device on the system should be tampered to force communication with the receiver.

The same principles apply to the learning & placing of devices, and as such tampering should start with the device closest to the receiver and working outwards, allowing for the mesh network to be re-established.



To start commission mode put the expander into tamper. For a wireless panel place the jumper on "Fit for Commission" mode located between the 2 aeriels of the control panel. Wait for a minimum of 15 minutes for the mesh network to be built. Systems should be checked using a PC and Ricochet Monitor programme. Always use the latest version available from our website.

## 9.0 Specifications

### 9.1 Electrical

<b>Operating Voltage</b>	10 - 13.7VDC
<b>Current Consumption</b>	<120mA
<b>Network</b>	4-wire standard 7/0.2 alarm cable up to 250m. Star, Daisy Chain or any combination.
<b>Outputs 1 - 8</b>	Not Used
<b>Operating Temperature</b>	-10 <sup>0</sup> C (+14 <sup>0</sup> F) to +50 <sup>0</sup> C (+122 <sup>0</sup> F)
<b>Storage Temperature</b>	-20 <sup>0</sup> C (-4 <sup>0</sup> F) to +60 <sup>0</sup> C (+140 <sup>0</sup> F)
<b>Maximum Humidity</b>	95% non-condensing
<b>EMC Environment</b>	Residential, Commercial, Light Industrial or Industrial

### 9.2 Physical

<b>Dimensions</b>	170mm H x 140mm W x 35mm D
<b>Packed Weight</b>	500gms

## 9.3 Wireless

<b>Frequency</b>	868.0MHz – 868.6MHz or 433.05MHz – 434.79MHz or 866.0Mhz – 866.6MHz <i>Please refer to product label to determine frequency</i>	
<b>Product Type</b>	GCA1000-2 Frequency 868MHz GCA2000 -2 Frequency 433MHz GCD1000-2 868MHz Frequency GCD2000 -2 433MHz Frequency GCA3000 866MHz Frequency GCD3000 866MHz Frequency	Not INCERT approved  Not INCERT approved Not INCERT approved Not INCERT approved
<b>Receiver</b>	Category 1	Class 2
<b>Receiver LBT (Listen Before Talk)</b>	Yes	
<b>Transmitter Duty Cycle</b>	433MHz <10%	868MHz <1%

## 9.4 Standards



Texcom declares that this product complies with the requirements of the following directives

- 2014/53/EU RE Directive
- 2011/65/EU ROHS Directive

The product therefore meets all the requirements to enable it to be CE marked.

WEEE Directive: 2012/19/EU (WEEE directive): Products marked with this symbol cannot be disposed of as unsorted municipal waste in the European Union. For proper recycling, return this product to your local supplier upon the purchase of equivalent new equipment, or dispose of it at designated collection points. For more information see: [www.recyclethis.info](http://www.recyclethis.info).

This product is a Type B Moveable device and is suitable for use in systems designed to comply with EN 50131-1, EN50131-3, EN50131-5-3 and PD6662 at Grade 2 and Environmental Class II.

Certified by Telefication BV

Hereby Texecom declares that the radio equipment type: GCA1000-2 and GCD1000-2 Premier Elite 32XP-W and Premier Elite 8XP-W is in compliance with Directive 2014/53/EU. The full EU declaration of conformity is available here <http://www.texe.com/cert/doc/DEC-T00192.pdf>

## 9.5 Warranty

All Texecom products are designed for reliable, trouble-free operation. Quality is carefully monitored by extensive computerised testing. As a result the *Premier 8XP-W & 32XP-W* expander is covered by a two-year warranty against defects in material or workmanship.

As the *Premier Elite 8 XP-W & 32XP-W* expander is not a complete alarm system but only a part thereof, Texecom cannot accept responsibility or liability for any damages whatsoever based on a claim that the *Premier Elite 8 XP-W & 32XP-W* expander/s failed to function correctly. Due to our policy of continuous improvement Texecom reserve the right to change specification without prior notice.

*Premier, Premier Elite, SmartKey, Ricochet & SignalSecurity* are trademarks of Texecom Ltd.

© TEXECOM LTD 2017