

PRODUCT CODE: MP1-10
CHANNEL BRACKET

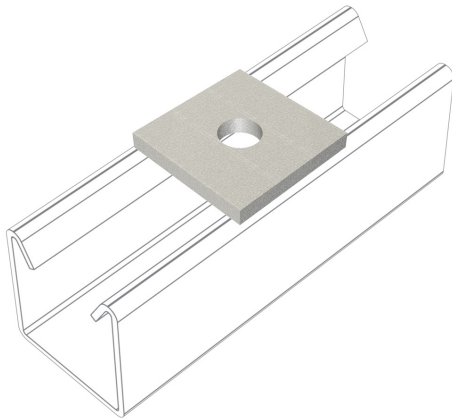

DESCRIPTION

Square Plate Washer

FINISH

Hot Dipped Galvanised

MATERIAL

Steel

PACKAGING

Packed in qty 100

ADDITIONAL NOTES

Compliant to LU Standard 1-085 (for use on surface & sub-surface locations)

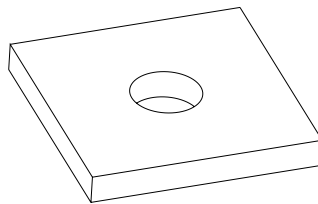

Isometric view

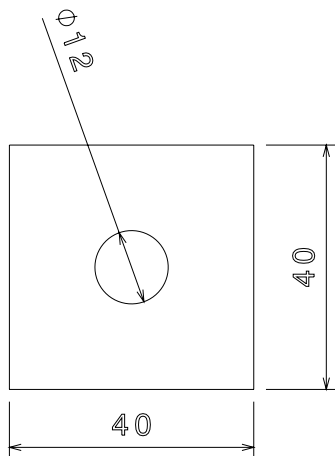

Front view

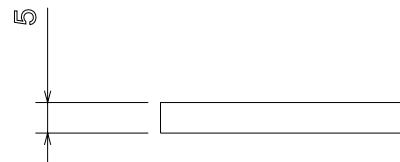

Side view